

**TLC225x, TLC225xA**  
**Advanced LinCMOS™ RAIL-TO-RAIL**  
**VERY LOW-POWER OPERATIONAL AMPLIFIERS**

SLOS176D – FEBRUARY 1997 – REVISED MARCH 2001

- **Output Swing Includes Both Supply Rails**
- **Low Noise . . . 19 nV/√Hz Typ at f = 1 kHz**
- **Low Input Bias Current . . . 1 pA Typ**
- **Fully Specified for Both Single-Supply and Split-Supply Operation**
- **Very Low Power . . . 35 μA Per Channel Typ**
- **Common-Mode Input Voltage Range Includes Negative Rail**
- **Low Input Offset Voltage**  
850 μV Max at T<sub>A</sub> = 25°C (TLC225xA)
- **Macromodel Included**
- **Performance Upgrades for the TS27L2/L4 and TLC27L2/L4**
- **Available in Q-Temp Automotive HighRel Automotive Applications Configuration Control / Print Support Qualification to Automotive Standards**

**description**

The TLC2252 and TLC2254 are dual and quadruple operational amplifiers from Texas Instruments. Both devices exhibit rail-to-rail output performance for increased dynamic range in single- or split-supply applications. The TLC225x family consumes only 35 μA of supply current per channel. This micropower operation makes them good choices for battery-powered applications. The noise performance has been dramatically improved over previous generations of CMOS amplifiers. Looking at Figure 1, the TLC225x has a noise level of 19 nV/√Hz at 1kHz; four times lower than competitive micropower solutions.

The TLC225x amplifiers, exhibiting high input impedance and low noise, are excellent for small-signal conditioning for high-impedance sources, such as piezoelectric transducers. Because of the micropower dissipation levels, these devices work well in hand-held monitoring and remote-sensing applications. In addition, the rail-to-rail output feature with single or split supplies makes this family a great choice when interfacing with analog-to-digital converters (ADCs). For precision applications, the TLC225xA family is available and has a maximum input offset voltage of 850 μV. This family is fully characterized at 5 V and ±5 V.

The TLC2252/4 also makes great upgrades to the TLC27L2/L4 or TS27L2/L4 in standard designs. They offer increased output dynamic range, lower noise voltage, and lower input offset voltage. This enhanced feature set allows them to be used in a wider range of applications. For applications that require higher output drive and wider input voltage ranges, see the TLV2432 and TLV2442 devices. If the design requires single amplifiers, please see the TLV2211/21/31 family. These devices are single rail-to-rail operational amplifiers in the SOT-23 package. Their small size and low power consumption, make them ideal for high density, battery-powered equipment.

**EQUIVALENT INPUT NOISE VOLTAGE  
VS  
FREQUENCY**

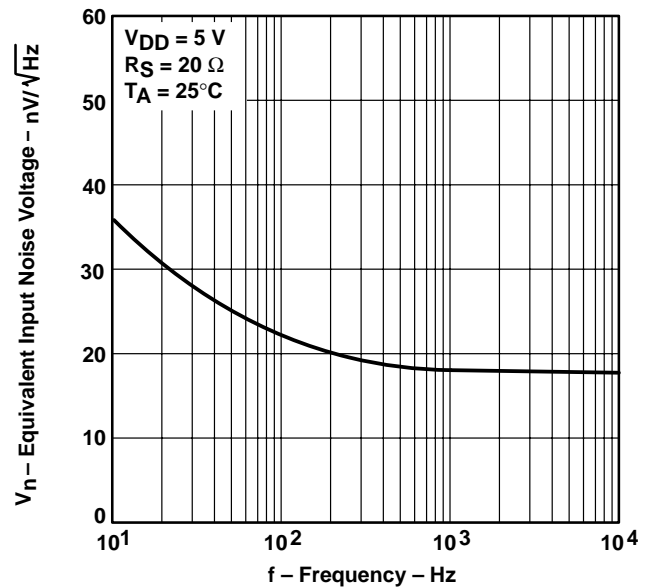

**Figure 1**



Please be aware that an important notice concerning availability, standard warranty, and use in critical applications of Texas Instruments semiconductor products and disclaimers thereto appears at the end of this data sheet.

Advanced LinCMOS is a trademark of Texas Instruments.

PRODUCTION DATA information is current as of publication date. Products conform to specifications per the terms of Texas Instruments standard warranty. Production processing does not necessarily include testing of all parameters.



POST OFFICE BOX 655303 • DALLAS, TEXAS 75265

Copyright © 2001, Texas Instruments Incorporated  
 On products compliant to MIL-PRF-38535, all parameters are tested unless otherwise noted. On all other products, production processing does not necessarily include testing of all parameters.

**TLC225x, TLC225xA**  
**Advanced LinCMOS™ RAIL-TO-RAIL**  
**VERY LOW-POWER OPERATIONAL AMPLIFIERS**

SLOS176D – FEBRUARY 1997 – REVISED MARCH 2001

**TLC2252 AVAILABLE OPTIONS**

| T <sub>A</sub> | V <sub>IO</sub> max<br>AT 25°C | PACKAGED DEVICES         |                           |                           |                         |                  |                            |
|----------------|--------------------------------|--------------------------|---------------------------|---------------------------|-------------------------|------------------|----------------------------|
|                |                                | SMALL<br>OUTLINE†<br>(D) | CHIP<br>CARRIER<br>(FK)   | CERAMIC<br>DIP<br>(JG)    | PLASTIC<br>DIP<br>(P)   | TSSOP‡<br>(PW)   | CERAMIC<br>FLATPACK<br>(U) |
| 0°C to 70°C    | 1500 µV                        | TLC2252CD                | —                         | —                         | TLC2252CP               | TLC2252CPW       | —                          |
| –40°C to 125°C | 850 µV<br>1500 µV              | TLC2252AID<br>TLC2252ID  | —<br>—                    | —<br>—                    | TLC2252AIP<br>TLC2252IP | TLC2252AIPW<br>— | —<br>—                     |
| –40°C to 125°C | 850 µV<br>1500 µV              | TLC2252AQD<br>TLC2252QD  | —<br>—                    | —<br>—                    | —<br>—                  | —<br>—           | —<br>—                     |
| –55°C to 125°C | 850 µV<br>1500 µV              | —<br>—                   | TLC2252AMFK<br>TLC2252MFK | TLC2252AMJG<br>TLC2252MJG | —<br>—                  | —<br>—           | TLC2252AMU<br>TLC2252MU    |

† The D packages are available taped and reeled. Add R suffix to device type (e.g., TLC2262CDR).

‡ The PW package is available only left-ended taped and reeled.

§ Chip forms are tested at 25°C only.

**TLC2254 AVAILABLE OPTIONS**

| T <sub>A</sub>    | V <sub>IO</sub> max<br>AT 25°C | PACKAGED DEVICES         |                           |                         |                         |                  |                            |
|-------------------|--------------------------------|--------------------------|---------------------------|-------------------------|-------------------------|------------------|----------------------------|
|                   |                                | SMALL<br>OUTLINE†<br>(D) | CHIP<br>CARRIER<br>(FK)   | CERAMIC<br>DIP<br>(J)   | PLASTIC<br>DIP<br>(N)   | TSSOP‡<br>(PW)   | CERAMIC<br>FLATPACK<br>(W) |
| 0°C to<br>70°C    | 1500 µV                        | TLC2254CD                | —                         | —                       | TLC2254CN               | TLC2254CPW       | —                          |
| –40°C to<br>125°C | 850 µV<br>1500 µV              | TLC2254AID<br>TLC2254ID  | —<br>—                    | —<br>—                  | TLC2254AIN<br>TLC2254IN | TLC2254AIPW<br>— | —<br>—                     |
| –40°C to<br>125°C | 850 µV<br>1500 µV              | TLC2254AQD<br>TLC2254QD  | —<br>—                    | —<br>—                  | —<br>—                  | —<br>—           | —<br>—                     |
| –55°C to<br>125°C | 850 µV<br>1500 µV              | —<br>—                   | TLC2254AMFK<br>TLC2254MFK | TLC2254AMJ<br>TLC2254MJ | —<br>—                  | —<br>—           | TLC2254AMW<br>TLC2254MW    |

† The D packages are available taped and reeled. Add R suffix to the device type (e.g., TLC2254CDR).

‡ The PW package is available only left-end taped and reeled. Chips are tested at 25°C.

§ Chip forms are tested at 25°C only.



**TLC225x, TLC225xA**  
**Advanced LinCMOS™ RAIL-TO-RAIL**  
**VERY LOW-POWER OPERATIONAL AMPLIFIERS**

SLOS176D – FEBRUARY 1997 – REVISED MARCH 2001

**TLC2252C, TLC2252AC**  
**TLC2252I, TLC2252AI**  
**TLC2252Q, TLC2252AQ**  
**D, P, OR PW PACKAGE**  
**(TOP VIEW)**

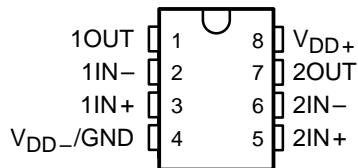

**TLC2252M, TLC2252AM ... FK PACKAGE**  
**(TOP VIEW)**

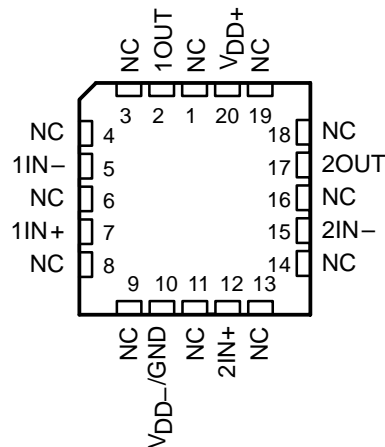

**TLC2252M, TLC2252AM ... JG PACKAGE**  
**(TOP VIEW)**

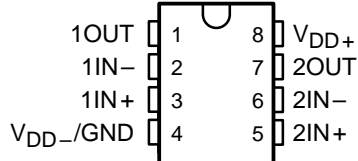

**TLC2262M, TLC2252AM ... U PACKAGE**  
**(TOP VIEW)**

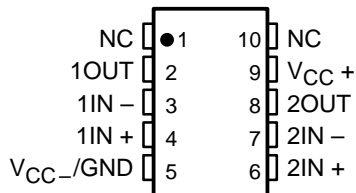

**TLC2254C, TLC2254AC**  
**TLC2254I, TLC2254AI**  
**TLC2254Q, TLC2254AQ**  
**D, N, OR PW PACKAGE**  
**(TOP VIEW)**

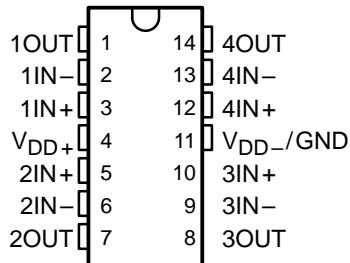

**TLC2254M, TLC2254AM**  
**J OR W PACKAGE**  
**(TOP VIEW)**



**TLC2254M, TLC2254AM**  
**FK PACKAGE**  
**(TOP VIEW)**

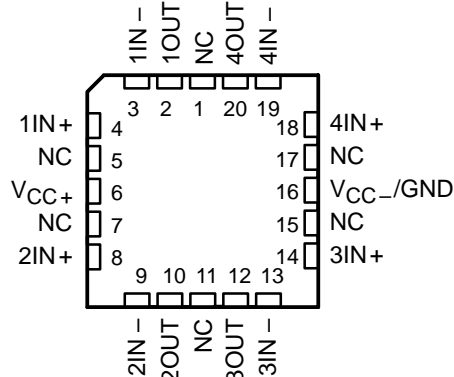

NC – No internal connection

**TLC225x, TLC225xA**  
**Advanced LinCMOS™ RAIL-TO-RAIL**  
**VERY LOW-POWER OPERATIONAL AMPLIFIERS**

SLOS176D – FEBRUARY 1997 – REVISED MARCH 2001

equivalent schematic (each amplifier)

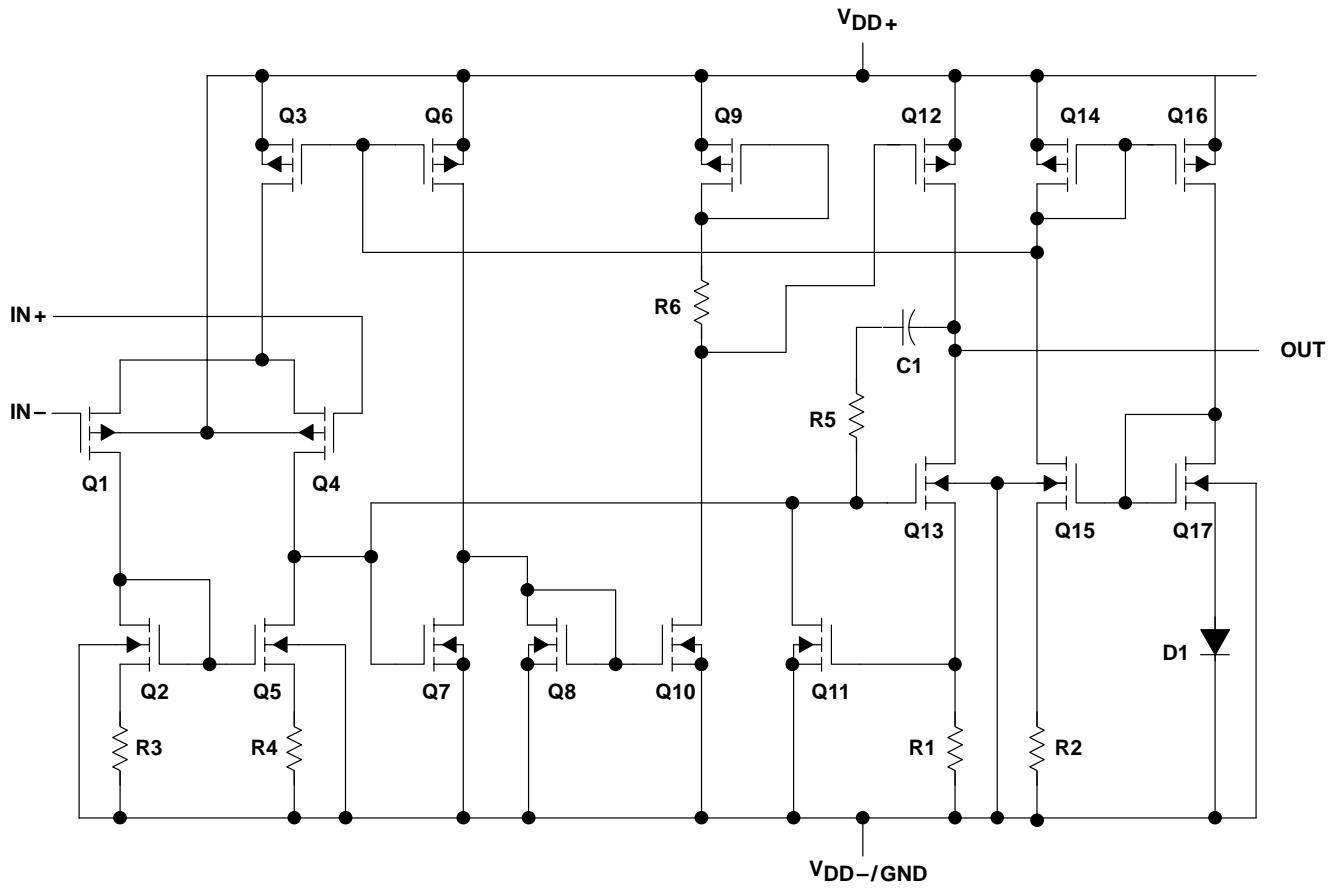

| ACTUAL DEVICE COMPONENT COUNT† |         |         |
|--------------------------------|---------|---------|
| COMPONENT                      | TLC2252 | TLC2254 |
| Transistors                    | 38      | 76      |
| Resistors                      | 30      | 56      |
| Diodes                         | 9       | 18      |
| Capacitors                     | 3       | 6       |

† Includes both amplifiers and all ESD, bias, and trim circuitry

**TLC225x, TLC225xA**  
**Advanced LinCMOS™ RAIL-TO-RAIL**  
**VERY LOW-POWER OPERATIONAL AMPLIFIERS**

SLOS176D – FEBRUARY 1997 – REVISED MARCH 2001

**absolute maximum ratings over operating free-air temperature range (unless otherwise noted)†**

|   |                              |
|---|------------------------------|
| Supply voltage, $V_{DD+}$ (see Note 1)                            | 8 V                          |
| Supply voltage, $V_{DD-}$ (see Note 1)                            | –8 V                         |
| Differential input voltage, $V_{ID}$ (see Note 2)                 | ±16 V                        |
| Input voltage, $V_I$ (any input, see Note 1)                      | ±8 V                         |
| Input current, $I_I$ (each input)                                 | ±5 mA                        |
| Output current, $I_O$   | ±50 mA                       |
| Total current into $V_{DD+}$                                      | ±50 mA                       |
| Total current out of $V_{DD-}$                                    | ±50 mA                       |
| Duration of short-circuit current at (or below) 25°C (see Note 3) | unlimited                    |
| Continuous total dissipation                                      | See Dissipation Rating Table |
| Operating free-air temperature range, $T_A$ : C suffix            | 0°C to 70°C                  |
| I suffix  | –40°C to 125°C               |
| Q suffix  | –40°C to 125°C               |
| M suffix  | –55°C to 125°C               |
| Storage temperature range, $T_{stg}$                              | –65°C to 150°C               |
| Lead temperature 1,6 mm (1/16 inch) from case for 10 seconds      | 260°C                        |

† Stresses beyond those listed under “absolute maximum ratings” may cause permanent damage to the device. These are stress ratings only, and functional operation of the device at these or any other conditions beyond those indicated under “recommended operating conditions” is not implied. Exposure to absolute-maximum-rated conditions for extended periods may affect device reliability.

- NOTES: 1. All voltage values, except differential voltages, are with respect to the midpoint between  $V_{DD+}$  and  $V_{DD-}$ .  
2. Differential voltages are at  $IN+$  with respect to  $IN-$ . Excessive current flows when input is brought below  $V_{DD-} - 0.3$  V.  
3. The output may be shorted to either supply. Temperature and/or supply voltages must be limited to ensure that the maximum dissipation rating is not exceeded.

**DISSIPATION RATING TABLE**

| PACKAGE | $T_A \leq 25^\circ\text{C}$<br>POWER RATING | DERATING FACTOR<br>ABOVE $T_A = 25^\circ\text{C}$ | $T_A = 70^\circ\text{C}$<br>POWER RATING | $T_A = 85^\circ\text{C}$<br>POWER RATING | $T_A = 125^\circ\text{C}$<br>POWER RATING |
|---------|---|---|--|--|---|
| D–8     | 724 mW                                      | 5.8 mW/°C   | 464 mW                                   | 377 mW                                   | 144 mW                                    |
| D–14    | 950 mW                                      | 7.6 mW/°C   | 608 mW                                   | 450 mW                                   | 190 mW                                    |
| FK      | 1375 mW                                     | 11.0 mW/°C  | 880 mW                                   | 715 mW                                   | 275 mW                                    |
| J       | 1375 mW                                     | 11.0 mW/°C  | 880 mW                                   | 715 mW                                   | 275 mW                                    |
| JG      | 1050 mW                                     | 8.4 mW/°C   | 672 mW                                   | 546 mW                                   | 275 mW                                    |
| N       | 1150 mW                                     | 9.2 mW/°C   | 736 mW                                   | 736 mW                                   | —   |
| P       | 1000 mW                                     | 8.0 mW/°C   | 640 mW                                   | 520 mW                                   | —   |
| PW–8    | 525 mW                                      | 4.2 mW/°C   | 336 mW                                   | 273 mW                                   | —   |
| PW–14   | 700 mW                                      | 5.6 mW/°C   | 448 mW                                   | 448 mW                                   | —   |
| U       | 700 mW                                      | 5.5 mW/°C   | 246 mW                                   | 330 mW                                   | 150 mW                                    |
| W       | 700 mW                                      | 5.5 mW/°C   | 246 mW                                   | 330 mW                                   | 150 mW                                    |

**recommended operating conditions**

|                                       | C SUFFIX  |                 | I SUFFIX  |                 | Q SUFFIX  |                 | M SUFFIX  |                 | UNIT |
|---------------------------------------|-----------|-----------------|-----------|-----------------|-----------|-----------------|-----------|-----------------|------|
|                                       | MIN       | MAX             | MIN       | MAX             | MIN       | MAX             | MIN       | MAX             |      |
| Supply voltage, $V_{DD\pm}$           | ±2.2      | ±8              | ±2.2      | ±8              | ±2.2      | ±8              | ±2.2      | ±8              | V    |
| Input voltage range, $V_I$            | $V_{DD-}$ | $V_{DD+} - 1.5$ | $V_{DD-}$ | $V_{DD+} - 1.5$ | $V_{DD-}$ | $V_{DD+} - 1.5$ | $V_{DD-}$ | $V_{DD+} - 1.5$ | V    |
| Common-mode input voltage, $V_{IC}$   | $V_{DD-}$ | $V_{DD+} - 1.5$ | $V_{DD-}$ | $V_{DD+} - 1.5$ | $V_{DD-}$ | $V_{DD+} - 1.5$ | $V_{DD-}$ | $V_{DD+} - 1.5$ | V    |
| Operating free-air temperature, $T_A$ | 0         | 70              | –40       | 125             | –40       | 125             | –55       | 125             | °C   |



**TLC225x, TLC225xA**  
**Advanced LinCMOS™ RAIL-TO-RAIL**  
**VERY LOW-POWER OPERATIONAL AMPLIFIERS**

SLOS176D – FEBRUARY 1997 – REVISED MARCH 2001

**electrical characteristics at specified free-air temperature,  $V_{DD} = 5\text{ V}$  (unless otherwise noted)**

| PARAMETER  | TEST CONDITIONS   | $T_A$ †  | TLC2252C                            |             |                              | UNIT |
|--|---|--|-------------------------------------|-------------|------------------------------|------|
|  |   |  | MIN                                 | TYP         | MAX                          |      |
| $V_{IO}$ Input offset voltage  | $V_{IC} = 0,$<br>$V_O = 0,$<br>$V_{DD} \pm = \pm 2.5\text{ V},$<br>$R_S = 50\ \Omega$ | 25°C   | 200                                 | 1500        | $\mu\text{V}$                |      |
|  |   | Full range   | 1750                                |             |                              |      |
| $\alpha_{VIO}$ Temperature coefficient of input offset voltage             |   | 25°C to 70°C   | 0.5                                 |             | $\mu\text{V}/^\circ\text{C}$ |      |
| Input offset voltage long-term drift (see Note 4)                          |   | 25°C   | 0.003                               |             | $\mu\text{V}/\text{mo}$      |      |
| $I_{IO}$ Input offset current  |   | 25°C   | 0.5                                 | 60          | $\text{pA}$                  |      |
|  |   | Full range   | 100                                 |             |                              |      |
| $I_{IB}$ Input bias current  |   | 25°C   | 1                                   | 60          | $\text{pA}$                  |      |
|  |   | Full range   | 100                                 |             |                              |      |
| $V_{ICR}$ Common-mode input voltage range                                  | $R_S = 50\ \Omega,$<br>$ V_{IO}  \leq 5\text{ mV}$                                    | 25°C   | 0 to 4                              | -0.3 to 4.2 | V                            |      |
|  |   | Full range   | 0 to 3.5                            |             |                              |      |
| $V_{OH}$ High-level output voltage   | $I_{OH} = -20\ \mu\text{A}$   | 25°C   | 4.98                                |             | V                            |      |
|  | $I_{OH} = -75\ \mu\text{A}$   | 25°C   | 4.9                                 | 4.94        |                              |      |
|  | Full range  | 4.8  |                                     |             |                              |      |
|  | $I_{OH} = -150\ \mu\text{A}$  | 25°C   | 4.8                                 | 4.88        |                              |      |
| $V_{OL}$ Low-level output voltage  | $V_{IC} = 2.5\text{ V},$<br>$I_{OL} = 50\ \mu\text{A}$                                | 25°C   | 0.01                                |             | V                            |      |
|  | $V_{IC} = 2.5\text{ V},$<br>$I_{OL} = 500\ \mu\text{A}$                               | 25°C   | 0.09                                | 0.15        |                              |      |
|  |   | Full range   | 0.15                                |             |                              |      |
|  | $V_{IC} = 2.5\text{ V},$<br>$I_{OL} = 1\text{ mA}$                                    | 25°C   | 0.2                                 | 0.3         |                              |      |
|  |   | Full range   | 0.3                                 |             |                              |      |
|  | $V_{IC} = 2.5\text{ V},$<br>$I_{OL} = 4\text{ mA}$                                    | 25°C   | 0.7                                 | 1           |                              |      |
|  |   | Full range   | 1.2                                 |             |                              |      |
|  | $A_{VD}$ Large-signal differential voltage amplification                              | $V_{IC} = 2.5\text{ V},$<br>$V_O = 1\text{ V to }4\text{ V}$ | $R_L = 100\text{ k}\Omega^\ddagger$ | 25°C        |                              | 100  |
| Full range   |   |  | 10                                  |             |                              |      |
| $R_L = 1\text{ M}\Omega^\ddagger$  |   |  | 25°C                                | 1700        |                              |      |
| $r_{id}$ Differential input resistance                                     |   | 25°C   | $10^{12}$                           |             | $\Omega$                     |      |
| $r_{ic}$ Common-mode input resistance                                      |   | 25°C   | $10^{12}$                           |             | $\Omega$                     |      |
| $c_{ic}$ Common-mode input capacitance                                     | $f = 10\text{ kHz},$<br>P package   | 25°C   | 8                                   |             | pF                           |      |
| $z_o$ Closed-loop output impedance   | $f = 25\text{ kHz},$<br>$A_V = 10$  | 25°C   | 200                                 |             | $\Omega$                     |      |
| CMRR Common-mode rejection ratio   | $V_{IC} = 0\text{ to }2.7\text{ V},$<br>$V_O = 2.5\text{ V},$<br>$R_S = 50\ \Omega$   | 25°C   | 70                                  | 83          | dB                           |      |
|  |   | Full range   | 70                                  |             |                              |      |
| $k_{SVR}$ Supply-voltage rejection ratio ( $\Delta V_{DD}/\Delta V_{IO}$ ) | $V_{DD} = 4.4\text{ V to }16\text{ V},$<br>$V_{IC} = V_{DD}/2,$<br>No load            | 25°C   | 80                                  | 95          | dB                           |      |
|  |   | Full range   | 80                                  |             |                              |      |
| $I_{DD}$ Supply current  | $V_O = 2.5\text{ V},$<br>No load  | 25°C   | 70                                  | 125         | $\mu\text{A}$                |      |
|  |   | Full range   | 150                                 |             |                              |      |

† Full range is 0°C to 70°C.

‡ Referenced to 2.5 V

NOTE 4: Typical values are based on the input offset voltage shift observed through 500 hours of operating life test at  $T_A = 150^\circ\text{C}$  extrapolated to  $T_A = 25^\circ\text{C}$  using the Arrhenius equation and assuming an activation energy of 0.96 eV.



**TLC225x, TLC225xA**  
**Advanced LinCMOS™ RAIL-TO-RAIL**  
**VERY LOW-POWER OPERATIONAL AMPLIFIERS**

SLOS176D – FEBRUARY 1997 – REVISED MARCH 2001

**operating characteristics at specified free-air temperature,  $V_{DD} = 5\text{ V}$**

| PARAMETER              |   | TEST CONDITIONS  |  | $T_A$ †    | TLC2252C   |      |                              | UNIT |
|------------------------|---|--|--|------------|------------|------|------------------------------|------|
|                        |   |  |  |            | MIN        | TYP  | MAX                          |      |
| SR                     | Slew rate at unity gain                     | $V_O = 1.5\text{ V to }3.5\text{ V}$ , $R_L = 100\text{ k}\Omega$ ‡, $C_L = 100\text{ pF}$ ‡ |  | 25°C       | 0.07       | 0.12 | $\text{V}/\mu\text{s}$       |      |
|                        |   |  |  | Full range | 0.05       |      |                              |      |
| $V_n$                  | Equivalent input noise voltage              | f = 10 Hz  |  | 25°C       | 36         |      | $\text{nV}/\sqrt{\text{Hz}}$ |      |
|                        |   | f = 1 kHz  |  | 25°C       | 19         |      |                              |      |
| $V_{N(PP)}$            | Peak-to-peak equivalent input noise voltage | f = 0.1 Hz to 1 Hz   |  | 25°C       | 0.7        |      | $\mu\text{V}$                |      |
|                        |   | f = 0.1 Hz to 10 Hz  |  | 25°C       | 1.1        |      |                              |      |
| $I_n$                  | Equivalent input noise current              |  |  | 25°C       | 0.6        |      | $\text{fA}/\sqrt{\text{Hz}}$ |      |
| THD + N                | Total harmonic distortion plus noise        | $V_O = 0.5\text{ V to }2.5\text{ V}$ ,<br>f = 10 kHz,<br>$R_L = 50\text{ k}\Omega$ ‡         |  | 25°C       | $A_V = 1$  |      |                              |      |
|                        |   |  |  |            | $A_V = 10$ |      |                              |      |
| Gain-bandwidth product |   | f = 10 kHz,<br>$C_L = 100\text{ pF}$ ‡   | $R_L = 50\text{ k}\Omega$ ‡            | 25°C       | 0.2        |      | MHz                          |      |
| $B_{OM}$               | Maximum output-swing bandwidth              | $V_{O(PP)} = 2\text{ V}$ ,<br>$R_L = 50\text{ k}\Omega$ ‡                                    | $A_V = 1$ ,<br>$C_L = 100\text{ pF}$ ‡ | 25°C       | 30         |      | kHz                          |      |
| $\phi_m$               | Phase margin at unity gain                  | $R_L = 50\text{ k}\Omega$ ‡  | $C_L = 100\text{ pF}$ ‡                | 25°C       | 63°        |      |                              |      |
| Gain margin            |   |  |  | 25°C       | 15         |      | dB                           |      |

† Full range is 0°C to 70°C.

‡ Referenced to 2.5 V

**TLC225x, TLC225xA**  
**Advanced LinCMOS™ RAIL-TO-RAIL**  
**VERY LOW-POWER OPERATIONAL AMPLIFIERS**

SLOS176D – FEBRUARY 1997 – REVISED MARCH 2001

**electrical characteristics at specified free-air temperature,  $V_{DD\pm} = \pm 5\text{ V}$  (unless otherwise specified)**

| PARAMETER  | TEST CONDITIONS   | T <sub>A</sub> †        | TLC2252C         |             |       | UNIT |
|--|---|-------------------------|------------------|-------------|-------|------|
|  |   |                         | MIN              | TYP         | MAX   |      |
| V <sub>IO</sub> Input offset voltage   | V <sub>IC</sub> = 0, V <sub>O</sub> = 0,<br>R <sub>S</sub> = 50 Ω             | 25°C                    | 200              | 1500        | μV    |      |
|  |   | Full range              | 1750             |             |       |      |
| αV <sub>IO</sub> Temperature coefficient of input offset voltage                       |   | 25°C to 70°C            | 0.5              |             | μV/°C |      |
| Input offset voltage long-term drift (see Note 4)                                      |   | 25°C                    | 0.003            |             | μV/mo |      |
| I <sub>IO</sub> Input offset current   |   | 25°C                    | 0.5              | 60          | pA    |      |
|  |   | Full range              | 100              |             |       |      |
| I <sub>IB</sub> Input bias current   |   | 25°C                    | 1                | 60          | pA    |      |
|  |   | Full range              | 100              |             |       |      |
| V <sub>ICR</sub> Common-mode input voltage range                                       | V <sub>IO</sub>   ≤ 5 mV, R <sub>S</sub> = 50 Ω                               | 25°C                    | -5 to 4          | -5.3 to 4.2 | V     |      |
|  |   | Full range              | -5 to 3.5        |             |       |      |
| V <sub>OM+</sub> Maximum positive peak output voltage                                  | I <sub>O</sub> = -20 μA   | 25°C                    | 4.98             |             | V     |      |
|  | I <sub>O</sub> = -100 μA  | 25°C                    | 4.9              | 4.93        |       |      |
|  |   | Full range              | 4.7              |             |       |      |
|  | I <sub>O</sub> = -200 μA  | 25°C                    | 4.8              | 4.86        |       |      |
| V <sub>OM-</sub> Maximum negative peak output voltage                                  | V <sub>IC</sub> = 0, I <sub>O</sub> = 50 μA                                   | 25°C                    | -4.99            |             | V     |      |
|  |   | 25°C                    | -4.85            | -4.91       |       |      |
|  | V <sub>IC</sub> = 0, I <sub>O</sub> = 500 μA                                  | Full range              | -4.85            |             |       |      |
|  |   | 25°C                    | -4.7             | -4.8        |       |      |
|  | V <sub>IC</sub> = 0, I <sub>O</sub> = 1 mA                                    | Full range              | -4.7             |             |       |      |
|  |   | 25°C                    | -4               | -4.3        |       |      |
|  | V <sub>IC</sub> = 0, I <sub>O</sub> = 4 mA                                    | Full range              | -3.8             |             |       |      |
|  |   | 25°C                    | 45               | 650         |       | V/mV |
| A <sub>VD</sub> Large-signal differential voltage amplification                        | V <sub>O</sub> = ±4 V   | R <sub>L</sub> = 100 kΩ | 10               |             |       |      |
|  |   | R <sub>L</sub> = 1 MΩ   | 3000             |             |       |      |
| 25°C   |   | 10                      |                  |             |       |      |
| r <sub>id</sub> Differential input resistance  |   | 25°C                    | 10 <sup>12</sup> |             | Ω     |      |
| r <sub>ic</sub> Common-mode input resistance   |   | 25°C                    | 10 <sup>12</sup> |             | Ω     |      |
| c <sub>ic</sub> Common-mode input capacitance  | f = 10 kHz, P package   | 25°C                    | 8                |             | pF    |      |
| z <sub>o</sub> Closed-loop output impedance  | f = 25 kHz, A <sub>V</sub> = 10   | 25°C                    | 190              |             | Ω     |      |
| CMRR Common-mode rejection ratio   | V <sub>IC</sub> = -5 V to 2.7 V,<br>V <sub>O</sub> = 0, R <sub>S</sub> = 50 Ω | 25°C                    | 75               | 88          | dB    |      |
|  |   | Full range              | 75               |             |       |      |
| k <sub>SVR</sub> Supply-voltage rejection ratio (ΔV <sub>DD±</sub> /ΔV <sub>IO</sub> ) | V <sub>DD±</sub> = 2.2 V to ±8 V,<br>V <sub>IC</sub> = 0, No load             | 25°C                    | 80               | 95          | dB    |      |
|  |   | Full range              | 80               |             |       |      |
| I <sub>DD</sub> Supply current   | V <sub>O</sub> = 0, No load   | 25°C                    | 80               | 125         | μA    |      |
|  |   | Full range              | 150              |             |       |      |

† Full range is 0°C to 70°C.

NOTE 4: Typical values are based on the input offset voltage shift observed through 500 hours of operating life test at T<sub>A</sub> = 150°C extrapolated to T<sub>A</sub> = 25°C using the Arrhenius equation and assuming an activation energy of 0.96 eV.





**TLC225x, TLC225xA**  
**Advanced LinCMOS™ RAIL-TO-RAIL**  
**VERY LOW-POWER OPERATIONAL AMPLIFIERS**

SLOS176D – FEBRUARY 1997 – REVISED MARCH 2001

**operating characteristics at specified free-air temperature,  $V_{DD\pm} = \pm 5\text{ V}$**

| PARAMETER   | TEST CONDITIONS   | $T_A$ †    | TLC2252C |      |                        | UNIT             |
|---|---|------------|----------|------|------------------------|------------------|
|   |   |            | MIN      | TYP  | MAX                    |                  |
| SR Slew rate at unity gain                              | $V_O = \pm 1.9\text{ V}$ ,<br>$R_L = 100\text{ k}\Omega$ ,<br>$C_L = 100\text{ pF}$                 | 25°C       | 0.07     | 0.12 |                        | V/ $\mu\text{s}$ |
|   |   | Full range | 0.05     |      |                        |                  |
| $V_n$ Equivalent input noise voltage                    | $f = 10\text{ Hz}$  | 25°C       | 38       |      | nV/ $\sqrt{\text{Hz}}$ |                  |
|   | $f = 1\text{ kHz}$  | 25°C       | 19       |      |                        |                  |
| $V_{N(PP)}$ Peak-to-peak equivalent input noise voltage | $f = 0.1\text{ Hz to }1\text{ Hz}$  | 25°C       | 0.8      |      | $\mu\text{V}$          |                  |
|   | $f = 0.1\text{ Hz to }10\text{ Hz}$   | 25°C       | 1.1      |      |                        |                  |
| $I_n$ Equivalent input noise current                    |   | 25°C       | 0.6      |      | fA/ $\sqrt{\text{Hz}}$ |                  |
| THD + N Total harmonic distortion pulse duration        | $V_O = \pm 2.3\text{ V}$ ,<br>$f = 10\text{ kHz}$ ,<br>$R_L = 50\text{ k}\Omega$                    | $A_V = 1$  | 0.2%     |      |                        |                  |
|   |   | $A_V = 10$ | 1%       |      |                        |                  |
| Gain-bandwidth product                                  | $f = 10\text{ kHz}$ ,<br>$R_L = 50\text{ k}\Omega$ ,<br>$C_L = 100\text{ pF}$                       | 25°C       | 0.21     |      | MHz                    |                  |
| $B_{OM}$ Maximum output-swing bandwidth                 | $V_{O(PP)} = 4.6\text{ V}$ ,<br>$R_L = 50\text{ k}\Omega$ ,<br>$A_V = 1$ ,<br>$C_L = 100\text{ pF}$ | 25°C       | 14       |      | kHz                    |                  |
| $\phi_m$ Phase margin at unity gain                     | $R_L = 50\text{ k}\Omega$ ,<br>$C_L = 100\text{ pF}$  | 25°C       | 63°      |      |                        |                  |
| Gain margin   |   | 25°C       | 15       |      | dB                     |                  |

† Full range is 0°C to 70°C.

**TLC225x, TLC225xA**  
**Advanced LinCMOS™ RAIL-TO-RAIL**  
**VERY LOW-POWER OPERATIONAL AMPLIFIERS**

SLOS176D – FEBRUARY 1997 – REVISED MARCH 2001

**electrical characteristics at specified free-air temperature,  $V_{DD} = 5\text{ V}$  (unless otherwise noted)**

| PARAMETER  | TEST CONDITIONS   | $T_A$ †   | TLC2254C   |             |               | UNIT                         |
|--|---|---|------------|-------------|---------------|------------------------------|
|  |   |   | MIN        | TYP         | MAX           |                              |
| $V_{IO}$ Input offset voltage  | $V_{IC} = 0,$<br>$V_O = 0,$<br>$V_{DD\pm} = \pm 2.5\text{ V},$<br>$R_S = 50\ \Omega$  | 25°C  | 200        | 1500        |               | $\mu\text{V}$                |
|  |   | Full range  |            | 1750        |               |                              |
| $\alpha_{V_{IO}}$ Temperature coefficient of input offset voltage          |   | 25°C to 70°C                                      | 0.5        |             |               | $\mu\text{V}/^\circ\text{C}$ |
|  |   | Input offset voltage long-term drift (see Note 4) | 25°C       | 0.003       |               |                              |
| $I_{IO}$ Input offset current  |   | 25°C  | 0.5        | 60          |               | $\text{pA}$                  |
|  |   | Full range  |            | 100         |               |                              |
| $I_{IB}$ Input bias current  |   | 25°C  | 1          | 60          |               | $\text{pA}$                  |
|  |   | Full range  |            | 100         |               |                              |
| $V_{ICR}$ Common-mode input voltage range                                  | $R_S = 50\ \Omega,$<br>$ V_{IO}  \leq 5\text{ mV}$  | 25°C  | 0 to 4     | -0.3 to 4.2 |               | $\text{V}$                   |
|  |   | Full range  | 0 to 3.5   |             |               |                              |
| $V_{OH}$ High-level output voltage   | $I_{OH} = -20\ \mu\text{A}$<br>$I_{OH} = -75\ \mu\text{A}$<br>$I_{OH} = -150\ \mu\text{A}$  | 25°C  |            | 4.98        |               | $\text{V}$                   |
|  |   | 25°C  | 4.9        | 4.94        |               |                              |
|  |   | Full range  | 4.8        |             |               |                              |
| $V_{OL}$ Low-level output voltage  | $V_{IC} = 2.5\text{ V},$<br>$I_{OL} = 50\ \mu\text{A}$<br>$I_{OL} = 500\ \mu\text{A}$<br>$I_{OL} = 1\text{ mA}$<br>$I_{OL} = 4\text{ mA}$ | 25°C  | 0.01       |             |               | $\text{V}$                   |
|  |   | 25°C  | 0.09       | 0.15        |               |                              |
|  |   | Full range  |            | 0.15        |               |                              |
|  |   | 25°C  | 0.2        | 0.3         |               |                              |
|  |   | Full range  |            | 0.3         |               |                              |
|  |   | 25°C  | 0.7        | 1           |               |                              |
| $A_{VD}$ Large-signal differential voltage amplification                   | $V_{IC} = 2.5\text{ V},$<br>$V_O = 1\text{ V to }4\text{ V}$  | $R_L = 100\ \text{k}\Omega$ ‡                     | 25°C       | 100         | 350           | $\text{V}/\text{mV}$         |
|  |   |   | Full range | 10          |               |                              |
|  |   | $R_L = 1\ \text{M}\Omega$ ‡                       | 25°C       |             | 1700          |                              |
| $r_{i(d)}$ Differential input resistance                                   |   | 25°C  |            | $10^{12}$   | $\Omega$      |                              |
| $r_{i(c)}$ Common-mode input resistance                                    |   | 25°C  |            | $10^{12}$   | $\Omega$      |                              |
| $c_{i(c)}$ Common-mode input capacitance                                   | $f = 10\ \text{kHz},$<br>N package  | 25°C  |            | 8           | $\text{pF}$   |                              |
| $z_o$ Closed-loop output impedance   | $f = 25\ \text{kHz},$<br>$A_V = 10$   | 25°C  |            | 200         | $\Omega$      |                              |
| CMRR Common-mode rejection ratio   | $V_{IC} = 0\text{ to }2.7\text{ V},$<br>$V_O = 2.5\text{ V},$<br>$R_S = 50\ \Omega$   | 25°C  | 70         | 83          | $\text{dB}$   |                              |
|  |   | Full range  | 70         |             |               |                              |
| $k_{SVR}$ Supply-voltage rejection ratio ( $\Delta V_{DD}/\Delta V_{IO}$ ) | $V_{DD} = 4.4\text{ V to }16\text{ V},$<br>$V_{IC} = V_{DD}/2,$<br>No load  | 25°C  | 80         | 95          | $\text{dB}$   |                              |
|  |   | Full range  | 80         |             |               |                              |
| $I_{DD}$ Supply current (four amplifiers)                                  | $V_O = 2.5\text{ V},$<br>No load  | 25°C  | 140        | 250         | $\mu\text{A}$ |                              |
|  |   | Full range  |            | 300         |               |                              |

† Full range is 0°C to 70°C.

‡ Referenced to 2.5 V

NOTE 4: Typical values are based on the input offset voltage shift observed through 500 hours of operating life test at  $T_A = 150^\circ\text{C}$  extrapolated to  $T_A = 25^\circ\text{C}$  using the Arrhenius equation and assuming an activation energy of 0.96 eV.



**TLC225x, TLC225xA**  
**Advanced LinCMOS™ RAIL-TO-RAIL**  
**VERY LOW-POWER OPERATIONAL AMPLIFIERS**

SLOS176D – FEBRUARY 1997 – REVISED MARCH 2001

**operating characteristics at specified free-air temperature,  $V_{DD} = 5\text{ V}$**

| PARAMETER   |   | TEST CONDITIONS  |  | $T_A$ †    | TLC2254C   |      |                              | UNIT |
|-------------|---|--|--|------------|------------|------|------------------------------|------|
|             |   |  |  |            | MIN        | TYP  | MAX                          |      |
| SR          | Slew rate at unity gain                     | $V_O = 1.4\text{ V to }2.6\text{ V}$<br>$R_L = 100\text{ k}\Omega$ ‡,<br>$C_L = 100\text{ pF}$ ‡ |  | 25°C       | 0.07       | 0.12 | $\text{V}/\mu\text{s}$       |      |
|             |   |  |  | Full range | 0.05       |      |                              |      |
| $V_n$       | Equivalent input noise voltage              |  |  | 25°C       | 36         |      | $\text{nV}/\sqrt{\text{Hz}}$ |      |
|             |   |  |  | 25°C       | 19         |      |                              |      |
| $V_{N(PP)}$ | Peak-to-peak equivalent input noise voltage |  |  | 25°C       | 0.7        |      | $\mu\text{V}$                |      |
|             |   |  |  | 25°C       | 1.1        |      |                              |      |
| $I_n$       | Equivalent input noise current              |  |  | 25°C       | 0.6        |      | $\text{fA}/\sqrt{\text{Hz}}$ |      |
| THD + N     | Total harmonic distortion plus noise        | $V_O = 0.5\text{ V to }2.5\text{ V}$ ,<br>$f = 10\text{ kHz}$ ,<br>$R_L = 50\text{ k}\Omega$ ‡   |  | 25°C       | $A_V = 1$  |      |                              |      |
|             |   |  |  |            | $A_V = 10$ |      |                              |      |
|             | Gain-bandwidth product                      | $f = 10\text{ kHz}$ ,<br>$C_L = 100\text{ pF}$ ‡   | $R_L = 50\text{ k}\Omega$ ‡,           | 25°C       | 0.2        |      | MHz                          |      |
| BOM         | Maximum output-swing bandwidth              | $V_{O(PP)} = 2\text{ V}$ ,<br>$R_L = 50\text{ k}\Omega$ ‡,                                       | $A_V = 1$ ,<br>$C_L = 100\text{ pF}$ ‡ | 25°C       | 30         |      | kHz                          |      |
| $\phi_m$    | Phase margin at unity gain                  | $R_L = 50\text{ k}\Omega$ ‡,   | $C_L = 100\text{ pF}$ ‡                | 25°C       | 63°        |      |                              |      |
|             | Gain margin                                 |  |  | 25°C       | 15         |      | dB                           |      |

† Full range is 0°C to 70°C.

‡ Referenced to 2.5 V

**TLC225x, TLC225xA**  
**Advanced LinCMOS™ RAIL-TO-RAIL**  
**VERY LOW-POWER OPERATIONAL AMPLIFIERS**

SLOS176D – FEBRUARY 1997 – REVISED MARCH 2001

**electrical characteristics at specified free-air temperature,  $V_{DD\pm} = \pm 5$  V (unless otherwise specified)**

| PARAMETER  | TEST CONDITIONS  | T <sub>A</sub> †        | TLC2254C         |             |       | UNIT |
|--|--|-------------------------|------------------|-------------|-------|------|
|  |  |                         | MIN              | TYP         | MAX   |      |
| V <sub>IO</sub> Input offset voltage   | V <sub>IC</sub> = 0, V <sub>O</sub> = 0,<br>R <sub>S</sub> = 50 Ω          | 25°C                    | 200              | 1500        | μV    |      |
|  |  | Full range              | 1750             |             |       |      |
| α <sub>VIO</sub> Temperature coefficient of input offset voltage                       |  | 25°C to 70°C            | 0.5              |             | μV/°C |      |
| Input offset voltage long-term drift (see Note 4)                                      |  | 25°C                    | 0.003            |             | μV/mo |      |
| I <sub>IO</sub> Input offset current   |  | 25°C                    | 0.5              | 60          | pA    |      |
|  |  | Full range              | 100              |             |       |      |
| I <sub>IB</sub> Input bias current   |  | 25°C                    | 1                | 60          | pA    |      |
|  |  | Full range              | 100              |             |       |      |
| V <sub>ICR</sub> Common-mode input voltage range                                       | V <sub>IO</sub>   ≤ 5 mV, R <sub>S</sub> = 50 Ω                            | 25°C                    | -5 to 4          | -5.3 to 4.2 | V     |      |
|  |  | Full range              | -5 to 3.5        |             |       |      |
| V <sub>OM+</sub> Maximum positive peak output voltage                                  | I <sub>O</sub> = -20 μA  | 25°C                    | 4.98             |             | V     |      |
|  | I <sub>O</sub> = -100 μA   | 25°C                    | 4.9              | 4.93        |       |      |
|  |  | Full range              | 4.7              |             |       |      |
|  | I <sub>O</sub> = -200 μA   | 25°C                    | 4.8              | 4.86        |       |      |
| V <sub>OM-</sub> Maximum negative peak output voltage                                  | V <sub>IC</sub> = 0, I <sub>O</sub> = 50 μA                                | 25°C                    | -4.99            |             | V     |      |
|  |  | Full range              | -4.85            |             |       |      |
|  | V <sub>IC</sub> = 0, I <sub>O</sub> = 500 μA                               | 25°C                    | -4.85            | -4.91       |       |      |
|  |  | Full range              | -4.85            |             |       |      |
|  | V <sub>IC</sub> = 0, I <sub>O</sub> = 1 mA                                 | 25°C                    | -4.7             | -4.8        |       |      |
|  |  | Full range              | -4.7             |             |       |      |
|  | V <sub>IC</sub> = 0, I <sub>O</sub> = 4 mA                                 | 25°C                    | -4               | -4.3        |       |      |
|  |  | Full range              | -3.8             |             |       |      |
| A <sub>VD</sub> Large-signal differential voltage amplification                        | V <sub>O</sub> = ±4 V  | R <sub>L</sub> = 100 kΩ | 25°C             | 40          | 150   | V/mV |
|  |  | R <sub>L</sub> = 1 MΩ   | Full range       | 10          |       |      |
|  |  |                         | 25°C             | 3000        |       |      |
| r <sub>i(d)</sub> Differential input resistance  |  | 25°C                    | 10 <sup>12</sup> |             | Ω     |      |
| r <sub>i(c)</sub> Common-mode input resistance   |  | 25°C                    | 10 <sup>12</sup> |             | Ω     |      |
| c <sub>i(c)</sub> Common-mode input capacitance  | f = 10 kHz, N package  | 25°C                    | 8                |             | pF    |      |
| z <sub>O</sub> Closed-loop output impedance  | f = 25 kHz, A <sub>V</sub> = 10  | 25°C                    | 190              |             | Ω     |      |
| CMRR Common-mode rejection ratio   | V <sub>IC</sub> = -5 V to 2.7 V, V <sub>O</sub> = 0, R <sub>S</sub> = 50 Ω | 25°C                    | 75               | 88          | dB    |      |
|  |  | Full range              | 75               |             |       |      |
| k <sub>SVR</sub> Supply-voltage rejection ratio (ΔV <sub>DD±</sub> /ΔV <sub>IO</sub> ) | V <sub>DD±</sub> = ±2.2 V to ±8 V, V <sub>IC</sub> = 0, No load            | 25°C                    | 80               | 95          | dB    |      |
|  |  | Full range              | 80               |             |       |      |
| I <sub>DD</sub> Supply current (four amplifiers)                                       | V <sub>O</sub> = 0, No load  | 25°C                    | 160              | 250         | μA    |      |
|  |  | Full range              | 300              |             |       |      |

† Full range is 0°C to 70°C.

NOTE 4: Typical values are based on the input offset voltage shift observed through 500 hours of operating life test at T<sub>A</sub> = 150°C extrapolated to T<sub>A</sub> = 25°C using the Arrhenius equation and assuming an activation energy of 0.96 eV.



**TLC225x, TLC225xA**  
**Advanced LinCMOS™ RAIL-TO-RAIL**  
**VERY LOW-POWER OPERATIONAL AMPLIFIERS**

SLOS176D – FEBRUARY 1997 – REVISED MARCH 2001

**operating characteristics at specified free-air temperature,  $V_{DD\pm} = \pm 5\text{ V}$**

| PARAMETER              |   | TEST CONDITIONS  |                                      | $T_A$ †    | TLC2254C   |      |                              | UNIT |
|------------------------|---|--|--------------------------------------|------------|------------|------|------------------------------|------|
|                        |   |  |                                      |            | MIN        | TYP  | MAX                          |      |
| SR                     | Slew rate at unity gain                     | $V_O = \pm 1.9\text{ V}$ ,<br>$C_L = 100\text{ pF}$                              | $R_L = 100\text{ k}\Omega$           | 25°C       | 0.07       | 0.12 | $\text{V}/\mu\text{s}$       |      |
|                        |   |  |                                      | Full range | 0.05       |      |                              |      |
| $V_n$                  | Equivalent input noise voltage              |  |                                      | 25°C       | 38         |      | $\text{nV}/\sqrt{\text{Hz}}$ |      |
|                        |   |  |                                      | 25°C       | 19         |      |                              |      |
| $V_{N(PP)}$            | Peak-to-peak equivalent input noise voltage |  |                                      | 25°C       | 0.8        |      | $\mu\text{V}$                |      |
|                        |   |  |                                      | 25°C       | 1.1        |      |                              |      |
| $I_n$                  | Equivalent input noise current              |  |                                      | 25°C       | 0.6        |      | $\text{fA}/\sqrt{\text{Hz}}$ |      |
| THD + N                | Total harmonic distortion plus noise        | $V_O = \pm 2.3\text{ V}$ ,<br>$f = 20\text{ kHz}$ ,<br>$R_L = 50\text{ k}\Omega$ |                                      | 25°C       | $A_V = 1$  |      |                              |      |
|                        |   |  |                                      |            | $A_V = 10$ |      |                              |      |
| Gain-bandwidth product |   | $f = 10\text{ kHz}$ ,<br>$C_L = 100\text{ pF}$                                   | $R_L = 50\text{ k}\Omega$            | 25°C       | 0.21       |      | MHz                          |      |
| $B_{OM}$               | Maximum output-swing bandwidth              | $V_{O(PP)} = 4.6\text{ V}$ ,<br>$R_L = 50\text{ k}\Omega$                        | $A_V = 1$ ,<br>$C_L = 100\text{ pF}$ | 25°C       | 14         |      | kHz                          |      |
| $\phi_m$               | Phase margin at unity gain                  | $R_L = 50\text{ k}\Omega$  | $C_L = 100\text{ pF}$                | 25°C       | 63°        |      |                              |      |
|                        | Gain margin                                 |  |                                      | 25°C       | 15         |      | dB                           |      |

† Full range is 0°C to 70°C.

**TLC225x, TLC225xA**  
**Advanced LinCMOS™ RAIL-TO-RAIL**  
**VERY LOW-POWER OPERATIONAL AMPLIFIERS**

SLOS176D – FEBRUARY 1997 – REVISED MARCH 2001

**electrical characteristics at specified free-air temperature,  $V_{DD} = 5\text{ V}$  (unless otherwise noted)**

| PARAMETER   | TEST CONDITIONS  | $T_A$ †                      | TLC2252I   |             |      | TLC2252AI |             |               | UNIT                         |
|---|--|------------------------------|------------|-------------|------|-----------|-------------|---------------|------------------------------|
|   |  |                              | MIN        | TYP         | MAX  | MIN       | TYP         | MAX           |                              |
| $V_{IO}$ Input offset voltage   | $V_{DD\pm} = \pm 2.5\text{ V}$ , $V_O = 0$ ,<br>$V_{IC} = 0$ , $R_S = 50\ \Omega$  | 25°C                         | 200        | 1500        |      | 200       | 850         | $\mu\text{V}$ |                              |
|   |  | Full range                   |            | 1750        |      | 1000      |             |               |                              |
| $\alpha_{VIO}$ Temperature coefficient of input offset voltage        |  | 25°C to 85°C                 | 0.5        |             |      | 0.5       |             |               | $\mu\text{V}/^\circ\text{C}$ |
| Input offset voltage long-term drift (see Note 4)                     |  | 25°C                         | 0.003      |             |      | 0.003     |             |               | $\mu\text{V}/\text{mo}$      |
| $I_{IO}$ Input offset current   |  | 25°C                         | 0.5        | 60          |      | 0.5       | 60          | $\text{pA}$   |                              |
|   |  | Full range                   |            | 1000        |      | 1000      |             |               |                              |
| $I_{IB}$ Input bias current   | 25°C   | 1                            | 60         |             | 1    | 60        | $\text{pA}$ |               |                              |
|   | Full range   |                              | 1000       |             | 1000 |           |             |               |                              |
| $V_{ICR}$ Common-mode input voltage range                             | $R_S = 50\ \Omega$ , $ V_{IO}  \leq 5\text{ mV}$                                   | 25°C                         | 0 to 4     | -0.3 to 4.2 |      | 0 to 4    | -0.3 to 4.2 | $\text{V}$    |                              |
|   |  | Full range                   | 3.5        |             |      | 3.5       |             |               |                              |
| $V_{OH}$ High-level output voltage                                    | $I_{OH} = -20\ \mu\text{A}$  | 25°C                         | 4.98       |             |      | 4.98      |             |               | $\text{V}$                   |
|   | $I_{OH} = -75\ \mu\text{A}$  | 25°C                         | 4.9        | 4.94        |      | 4.9       | 4.94        |               |                              |
|   | Full range   | 4.8                          |            |             | 4.8  |           |             |               |                              |
| $V_{OL}$ Low-level output voltage                                     | $V_{IC} = 2.5\text{ V}$ , $I_{OL} = 50\ \mu\text{A}$                               | 25°C                         | 0.01       |             |      | 0.01      |             |               | $\text{V}$                   |
|   | $V_{IC} = 2.5\text{ V}$ , $I_{OL} = 500\ \mu\text{A}$                              | 25°C                         | 0.09       | 0.15        |      | 0.09      | 0.15        |               |                              |
|   |  | Full range                   |            | 0.15        |      | 0.15      |             |               |                              |
|   | $V_{IC} = 2.5\text{ V}$ , $I_{OL} = 4\text{ mA}$                                   | 25°C                         | 0.8        | 1           |      | 0.7       | 1           |               |                              |
| Full range  |  |                              | 1.2        |             | 1.2  |           |             |               |                              |
| $A_{VD}$ Large-signal differential voltage amplification              | $V_{IC} = 2.5\text{ V}$ , $V_O = 1\text{ V to }4\text{ V}$                         | $R_L = 100\text{ k}\Omega$ ‡ | 25°C       | 100         | 350  |           | 100         | 350           | $\text{V/mV}$                |
|   |  |                              | Full range | 10          |      |           | 10          |               |                              |
|   |  | $R_L = 1\text{ M}\Omega$ ‡   | 25°C       | 1700        |      |           | 1700        |               |                              |
| $r_{id}$ Differential input resistance                                |  | 25°C                         | $10^{12}$  |             |      | $10^{12}$ |             |               | $\Omega$                     |
| $r_{ic}$ Common-mode input resistance                                 |  | 25°C                         | $10^{12}$  |             |      | $10^{12}$ |             |               | $\Omega$                     |
| $C_{ic}$ Common-mode input capacitance                                | $f = 10\text{ kHz}$ , P package  | 25°C                         | 8          |             |      | 8         |             |               | $\text{pF}$                  |
| $z_o$ Closed-loop output impedance                                    | $f = 25\text{ kHz}$ , $A_V = 10$   | 25°C                         | 200        |             |      | 200       |             |               | $\Omega$                     |
| CMRR Common-mode rejection ratio                                      | $V_{IC} = 0\text{ to }2.7\text{ V}$ , $V_O = 2.5\text{ V}$ ,<br>$R_S = 50\ \Omega$ | 25°C                         | 70         | 83          |      | 70        | 83          | $\text{dB}$   |                              |
|   |  | Full range                   | 70         |             |      | 70        |             |               |                              |
| kSVR Supply-voltage rejection ratio ( $\Delta V_{DD}/\Delta V_{IO}$ ) | $V_{DD} = 4.4\text{ V to }16\text{ V}$ ,<br>$V_{IC} = V_{DD}/2$ , No load          | 25°C                         | 80         | 95          |      | 80        | 95          | $\text{dB}$   |                              |
|   |  | Full range                   | 80         |             |      | 80        |             |               |                              |
| $I_{DD}$ Supply current   | $V_O = 2.5\text{ V}$ , No load   | 25°C                         | 70         | 125         |      | 70        | 125         | $\mu\text{A}$ |                              |
|   |  | Full range                   |            | 150         |      | 150       |             |               |                              |

† Full range is  $-40^\circ\text{C}$  to  $125^\circ\text{C}$ .

‡ Referenced to 2.5 V

NOTE 4: Typical values are based on the input offset voltage shift observed through 500 hours of operating life test at  $T_A = 150^\circ\text{C}$  extrapolated to  $T_A = 25^\circ\text{C}$  using the Arrhenius equation and assuming an activation energy of 0.96 eV.



**TLC225x, TLC225xA**  
**Advanced LinCMOS™ RAIL-TO-RAIL**  
**VERY LOW-POWER OPERATIONAL AMPLIFIERS**

SLOS176D – FEBRUARY 1997 – REVISED MARCH 2001

**operating characteristics at specified free-air temperature,  $V_{DD} = 5\text{ V}$**

| PARAMETER   | TEST CONDITIONS  | $T_A$ †  | TLC2252I                                    |      |     | TLC2252AI |      |     | UNIT                   |     |
|-------------|--|--|---|------|-----|-----------|------|-----|------------------------|-----|
|             |  |  | MIN   | TYP  | MAX | MIN       | TYP  | MAX |                        |     |
| SR          | Slew rate at unity gain<br>$V_O = 1.5\text{ V to }3.5\text{ V}$ , $R_L = 100\text{ k}\Omega$ ‡,<br>$C_L = 100\text{ pF}$ ‡   | 25°C   | 0.07  | 0.12 |     | 0.07      | 0.12 |     | V/ $\mu\text{s}$       |     |
|             |  | Full range   | 0.05  |      |     | 0.05      |      |     |                        |     |
| $V_n$       | Equivalent input noise voltage   | f = 10 Hz  | 36  |      |     | 36        |      |     | nV/ $\sqrt{\text{Hz}}$ |     |
|             |  | f = 1 kHz  | 19  |      |     | 19        |      |     |                        |     |
| $V_{N(PP)}$ | Peak-to-peak equivalent input noise voltage  | f = 0.1 Hz to 1 Hz   | 0.7   |      |     | 0.7       |      |     | $\mu\text{V}$          |     |
|             |  | f = 0.1 Hz to 10 Hz  | 1.1   |      |     | 1.1       |      |     |                        |     |
| $I_n$       | Equivalent input noise current   | 25°C   | 0.6   |      |     | 0.6       |      |     | fA/ $\sqrt{\text{Hz}}$ |     |
| THD + N     | Total harmonic distortion plus noise<br>$V_O = 0.5\text{ V to }2.5\text{ V}$ ,<br>f = 10 kHz,<br>$R_L = 50\text{ k}\Omega$ ‡ | $A_V = 1$  | 0.2%  |      |     | 0.2%      |      |     |                        |     |
|             |  | $A_V = 10$   | 1%  |      |     | 1%        |      |     |                        |     |
|             | Gain-bandwidth product   | f = 50 kHz,<br>$C_L = 100\text{ pF}$ ‡                     | $R_L = 50\text{ k}\Omega$ ‡,                | 0.2  |     |           | 0.2  |     |                        | MHz |
| BOM         | Maximum output-swing bandwidth   | $V_{O(PP)} = 2\text{ V}$ ,<br>$R_L = 50\text{ k}\Omega$ ‡, | $A_V = 1$ ,<br>$R_L = 50\text{ k}\Omega$ ‡, | 30   |     |           | 30   |     |                        | kHz |
| $\phi_m$    | Phase margin at unity gain   | $R_L = 50\text{ k}\Omega$ ‡,                               | $C_L = 100\text{ pF}$ ‡                     | 63°  |     |           | 63°  |     |                        |     |
|             |  |  |   | 15   |     |           | 15   |     |                        |     |
|             | Gain margin  | 25°C   | 15  |      |     | 15        |      |     | dB                     |     |

† Full range is –40°C to 125°C.

‡ Referenced to 2.5 V

**TLC225x, TLC225xA**  
**Advanced LinCMOS™ RAIL-TO-RAIL**  
**VERY LOW-POWER OPERATIONAL AMPLIFIERS**

SLOS176D – FEBRUARY 1997 – REVISED MARCH 2001

**electrical characteristics at specified free-air temperature,  $V_{DD\pm} = \pm 5$  V (unless otherwise noted)**

| PARAMETER   | TEST CONDITIONS   | $T_A$ †            | TLC2252I          |                  |      | TLC2252AI |                  |                  | UNIT   |
|---|---|--------------------|-------------------|------------------|------|-----------|------------------|------------------|--------|
|   |   |                    | MIN               | TYP              | MAX  | MIN       | TYP              | MAX              |        |
| $V_{IO}$ Input offset voltage   | $V_{IC} = 0, V_O = 0, R_S = 50 \Omega$                  | 25°C               | 200               | 1500             |      | 200       | 850              | $\mu V$          |        |
|   |   | Full range         |                   |                  | 1750 |           | 1000             |                  |        |
| $\alpha_{VIO}$ Temperature coefficient of input offset voltage                  |   | 25°C to 85°C       | 0.5               |                  |      | 0.5       |                  | $\mu V/^\circ C$ |        |
| Input offset voltage long-term drift (see Note 4)                               |   | 25°C               | 0.003             |                  |      | 0.003     |                  | $\mu V/mo$       |        |
| $I_{IO}$ Input offset current   |   | 25°C               | 0.5               | 60               |      | 0.5       | 60               | $pA$             |        |
|   |   | Full range         |                   |                  | 1000 |           | 1000             |                  |        |
| $I_{IB}$ Input bias current   | 25°C  | 1                  | 60                |                  | 1    | 60        | $pA$             |                  |        |
|   | Full range  |                    |                   | 1000             |      | 1000      |                  |                  |        |
| $V_{ICR}$ Common-mode input voltage range                                       | $R_S = 50 \Omega,  V_{IO}  \leq 5 mV$                   | 25°C               | -5 to 4           | -5.3 to 4.2      |      | -5 to 4   | -5.3 to 4.2      | V                |        |
|   |   | Full range         | -5 to 3.5         |                  |      | -5 to 3.5 |                  |                  |        |
| $V_{OM+}$ Maximum positive peak output voltage                                  | $I_O = -20 \mu A$                                       | 25°C               |                   | 4.98             |      | 4.98      | V                |                  |        |
|   | $I_O = -100 \mu A$                                      | 25°C               | 4.9               | 4.93             |      | 4.9       |                  | 4.93             |        |
|   |   | Full range         |                   | 4.7              |      |           |                  | 4.7              |        |
|   | $I_O = -200 \mu A$                                      | 25°C               | 4.8               | 4.86             |      | 4.8       |                  | 4.86             |        |
| $V_{OM-}$ Maximum negative peak output voltage                                  | $V_{IC} = 0, I_O = 50 \mu A$                            | 25°C               |                   | -4.99            |      | -4.99     | V                |                  |        |
|   | $V_{IC} = 0, I_O = 500 \mu A$                           | 25°C               | -4.85             | -4.91            |      | -4.85     |                  | -4.91            |        |
|   |   | Full range         |                   | -4.85            |      |           |                  | -4.85            |        |
|   | $V_{IC} = 0, I_O = 4 mA$                                | 25°C               | -4                | -4.3             |      | -4        |                  | -4.3             |        |
| $AVD$ Large-signal differential voltage amplification                           | $V_O = \pm 4 V$   | $R_L = 50 k\Omega$ | 25°C              | 40               | 150  |           | 40               | 150              | $V/mV$ |
|   |   |                    | Full range        |                  | 10   |           |                  | 10               |        |
|   |   |                    | $R_L = 1 M\Omega$ | 25°C             |      | 3000      |                  |                  |        |
| $r_{id}$ Differential input resistance  |   | 25°C               |                   | 10 <sup>12</sup> |      |           | 10 <sup>12</sup> | $\Omega$         |        |
| $r_{ic}$ Common-mode input resistance   |   | 25°C               |                   | 10 <sup>12</sup> |      |           | 10 <sup>12</sup> | $\Omega$         |        |
| $C_{ic}$ Common-mode input capacitance  | f = 10 kHz, P package                                   | 25°C               |                   | 8                |      |           | 8                | pF               |        |
| $Z_o$ Closed-loop output impedance  | f = 25 kHz, $A_V = 10$                                  | 25°C               |                   | 190              |      |           | 190              | $\Omega$         |        |
| CMRR Common-mode rejection ratio  | $V_{IC} = -5 V$ to 2.7 V, $V_O = 0, R_S = 50 \Omega$    | 25°C               | 75                | 88               |      | 75        | 88               | dB               |        |
|   |   | Full range         |                   | 75               |      |           | 75               |                  |        |
| $k_{SVR}$ Supply-voltage rejection ratio ( $\Delta V_{DD\pm} / \Delta V_{IO}$ ) | $V_{DD} = 4.4 V$ to 16 V, $V_{IC} = V_{DD}/2$ , No load | 25°C               | 80                | 95               |      | 80        | 95               | dB               |        |
|   |   | Full range         |                   | 80               |      |           | 80               |                  |        |
| $I_{DD}$ Supply current   | $V_O = 2.5 V$ , No load                                 | 25°C               | 80                | 125              |      | 80        | 125              | $\mu A$          |        |
|   |   | Full range         |                   |                  | 150  |           |                  |                  | 150    |

† Full range is -40°C to 125°C.

NOTE 4: Typical values are based on the input offset voltage shift observed through 500 hours of operating life test at  $T_A = 150^\circ C$  extrapolated to  $T_A = 25^\circ C$  using the Arrhenius equation and assuming an activation energy of 0.96 eV.





**TLC225x, TLC225xA**  
**Advanced LinCMOS™ RAIL-TO-RAIL**  
**VERY LOW-POWER OPERATIONAL AMPLIFIERS**

SLOS176D – FEBRUARY 1997 – REVISED MARCH 2001

**operating characteristics at specified free-air temperature,  $V_{DD\pm} = \pm 5$  V**

| PARAMETER   | TEST CONDITIONS  | $T_A$ †  | TLC2252I                |      |     | TLC2252AI |      |     | UNIT                   |     |
|-------------|--|--|-------------------------|------|-----|-----------|------|-----|------------------------|-----|
|             |  |  | MIN                     | TYP  | MAX | MIN       | TYP  | MAX |                        |     |
| SR          | Slew rate at unity gain<br>$V_O = \pm 1.9$ V, $R_L = 100$ k $\Omega$ ,<br>$C_L = 100$ pF | 25°C   | 0.07                    | 0.12 |     | 0.07      | 0.12 |     | V/ $\mu$ s             |     |
|             |  | Full range   | 0.05                    |      |     | 0.05      |      |     |                        |     |
| $V_n$       | Equivalent input noise voltage   | f = 10 Hz  | 25°C                    |      |     | 38        |      |     | nV/ $\sqrt{\text{Hz}}$ |     |
|             |  | f = 1 kHz  | 25°C                    |      |     | 19        |      |     |                        |     |
| $V_{N(PP)}$ | Peak-to-peak equivalent input noise voltage  | f = 0.1 Hz to 1 Hz   | 25°C                    |      |     | 0.8       |      |     | $\mu$ V                |     |
|             |  | f = 0.1 Hz to 10 Hz  | 25°C                    |      |     | 1.1       |      |     |                        |     |
| $I_n$       | Equivalent input noise current   | 25°C   | 0.6                     |      |     | 0.6       |      |     | fA/ $\sqrt{\text{Hz}}$ |     |
| THD + N     | Total harmonic distortion plus noise   | $V_O = \pm 2.3$ V,<br>$R_L = 50$ k $\Omega$ ,<br>f = 10 kHz                | $A_V = 1$               | 25°C |     |           | 0.2% |     |                        |     |
|             |  |  | $A_V = 10$              | 25°C |     |           | 1%   |     |                        |     |
|             | Gain-bandwidth product   | f = 10 kHz,<br>$C_L = 100$ pF  | $R_L = 50$ k $\Omega$ , | 25°C |     |           | 0.21 |     |                        | MHz |
| BOM         | Maximum output-swing bandwidth   | $V_{O(PP)} = 4.6$ V, $A_V = 1$ ,<br>$R_L = 50$ k $\Omega$ , $C_L = 100$ pF |                         | 25°C |     |           | 14   |     |                        | kHz |
| $\phi_m$    | Phase margin at unity gain   | $R_L = 50$ k $\Omega$ , $C_L = 100$ pF                                     | 25°C                    |      |     | 63°       |      |     |                        |     |
|             | Gain margin  |  | 25°C                    |      |     | 15        |      |     | dB                     |     |

† Full range is –40°C to 125°C.

**TLC225x, TLC225xA**  
**Advanced LinCMOS™ RAIL-TO-RAIL**  
**VERY LOW-POWER OPERATIONAL AMPLIFIERS**

SLOS176D – FEBRUARY 1997 – REVISED MARCH 2001

**electrical characteristics at specified free-air temperature,  $V_{DD} = 5\text{ V}$  (unless otherwise noted)**

| PARAMETER  | TEST CONDITIONS  | $T_A$ †                             | TLC2254I   |             |          | TLC2254AI |             |             | UNIT                         |                      |
|--|--|-------------------------------------|------------|-------------|----------|-----------|-------------|-------------|------------------------------|----------------------|
|  |  |                                     | MIN        | TYP         | MAX      | MIN       | TYP         | MAX         |                              |                      |
| $V_{IO}$ Input offset voltage  |  | 25°C                                | 200        |             | 1500     | 200       |             | 850         | $\mu\text{V}$                |                      |
|  |  | Full range                          | 1750       |             |          | 1000      |             |             |                              |                      |
| $\alpha_{VIO}$ Temperature coefficient of input offset voltage             | $V_{DD} \pm \pm 2.5\text{ V}$ ,<br>$V_{IC} = 0$ ,<br>$V_O = 0$ ,<br>$R_S = 50\ \Omega$ | 25°C to 125°C                       | 0.5        |             |          | 0.5       |             |             | $\mu\text{V}/^\circ\text{C}$ |                      |
| Input offset voltage long-term drift (see Note 4)                          |  | 25°C                                | 0.003      |             |          | 0.003     |             |             | $\mu\text{V}/\text{mo}$      |                      |
| $I_{IO}$ Input offset current  |  | 25°C                                | 0.5        | 60          |          | 0.5       | 60          |             | $\text{pA}$                  |                      |
|  |  | Full range                          | 1000       |             |          | 1000      |             |             |                              |                      |
| $I_{IB}$ Input bias current  | 25°C   | 1                                   | 60         |             | 1        | 60        |             | $\text{pA}$ |                              |                      |
|  | Full range   | 1000                                |            |             | 1000     |           |             |             |                              |                      |
| $V_{ICR}$ Common-mode input voltage range                                  | $R_S = 50\ \Omega$ , $ V_{IO}  \leq 5\text{ mV}$                                       | 25°C                                | 0 to 4     | -0.3 to 4.2 |          | 0 to 4    | -0.3 to 4.2 | $\text{V}$  |                              |                      |
|  |  | Full range                          | 0 to 3.5   |             | 0 to 3.5 |           |             |             |                              |                      |
| $V_{OH}$ High-level output voltage   | $I_{OH} = -20\ \mu\text{A}$  | 25°C                                | 4.98       |             |          | 4.98      |             |             | $\text{V}$                   |                      |
|  |  | 25°C                                | 4.9        | 4.94        |          | 4.9       | 4.94        |             |                              |                      |
|  |  | Full range                          | 4.8        |             |          | 4.8       |             |             |                              |                      |
| $V_{OL}$ Low-level output voltage  | $V_{IC} = 2.5\text{ V}$ , $I_{OL} = 50\ \mu\text{A}$                                   | 25°C                                | 0.01       |             |          | 0.01      |             |             | $\text{V}$                   |                      |
|  |  | 25°C                                | 0.09       | 0.15        |          | 0.09      | 0.15        |             |                              |                      |
|  | Full range   | 0.15                                |            |             | 0.15     |           |             |             |                              |                      |
|  | $V_{IC} = 2.5\text{ V}$ , $I_{OL} = 4\text{ mA}$                                       | 25°C                                | 0.8        | 1           |          | 0.7       | 1           |             |                              |                      |
|  |  | Full range                          | 1.2        |             |          | 1.2       |             |             |                              |                      |
| $A_{VD}$ Large-signal differential voltage amplification                   | $V_{IC} = 2.5\text{ V}$ ,<br>$V_O = 1\text{ V to }4\text{ V}$                          | $R_L = 100\text{ k}\Omega \ddagger$ | 25°C       | 100         | 350      |           | 100         | 350         |                              | $\text{V}/\text{mV}$ |
|  |  |                                     | Full range | 10          |          |           | 10          |             |                              |                      |
|  |  | $R_L = 1\text{ M}\Omega \ddagger$   | 25°C       | 1700        |          |           | 1700        |             |                              |                      |
| $r_{i(d)}$ Differential input resistance                                   |  | 25°C                                | $10^{12}$  |             |          | $10^{12}$ |             |             | $\Omega$                     |                      |
| $r_{i(c)}$ Common-mode input resistance                                    |  | 25°C                                | $10^{12}$  |             |          | $10^{12}$ |             |             | $\Omega$                     |                      |
| $C_{i(c)}$ Common-mode input capacitance                                   | $f = 10\text{ kHz}$ , N package  | 25°C                                | 8          |             |          | 8         |             |             | $\text{pF}$                  |                      |
| $Z_o$ Closed-loop output impedance   | $f = 25\text{ kHz}$ , $A_V = 10$   | 25°C                                | 200        |             |          | 200       |             |             | $\Omega$                     |                      |
| CMRR Common-mode rejection ratio   | $V_{IC} = 0\text{ to }2.7\text{ V}$ , $V_O = 2.5\text{ V}$ ,<br>$R_S = 50\ \Omega$     | 25°C                                | 70         | 83          |          | 70        | 83          |             | $\text{dB}$                  |                      |
|  |  | Full range                          | 70         |             |          | 70        |             |             |                              |                      |
| $k_{SVR}$ Supply-voltage rejection ratio ( $\Delta V_{DD}/\Delta V_{IO}$ ) | $V_{DD} = 4.4\text{ V to }16\text{ V}$ ,<br>$V_{IC} = V_{DD}/2$ , No load              | 25°C                                | 80         | 95          |          | 80        | 95          |             | $\text{dB}$                  |                      |
|  |  | Full range                          | 80         |             |          | 80        |             |             |                              |                      |
| $I_{DD}$ Supply current (four amplifiers)                                  | $V_O = 2.5\text{ V}$ , No load   | 25°C                                | 140        | 250         |          | 140       | 250         |             | $\mu\text{A}$                |                      |
|  |  | Full range                          | 300        |             |          | 300       |             |             |                              |                      |

† Full range is  $-40^\circ\text{C}$  to  $125^\circ\text{C}$ .

‡ Referenced to 2.5 V

NOTE 4: Typical values are based on the input offset voltage shift observed through 500 hours of operating life test at  $T_A = 150^\circ\text{C}$  extrapolated to  $T_A = 25^\circ\text{C}$  using the Arrhenius equation and assuming an activation energy of 0.96 eV.



**TLC225x, TLC225xA**  
**Advanced LinCMOS™ RAIL-TO-RAIL**  
**VERY LOW-POWER OPERATIONAL AMPLIFIERS**

SLOS176D – FEBRUARY 1997 – REVISED MARCH 2001

**operating characteristics at specified free-air temperature,  $V_{DD} = 5\text{ V}$**

| PARAMETER   | TEST CONDITIONS  | $T_A$ †    | TLC2254I                               |      |     | TLC2254AI |      |     | UNIT                   |
|-------------|--|------------|--|------|-----|-----------|------|-----|------------------------|
|             |  |            | MIN                                    | TYP  | MAX | MIN       | TYP  | MAX |                        |
| SR          | Slew rate at unity gain<br>$V_O = 1.4\text{ V to }2.6\text{ V}$ ,<br>$R_L = 100\text{ k}\Omega$ ‡,<br>$C_L = 100\text{ pF}$ ‡          | 25°C       | 0.07                                   | 0.12 |     | 0.07      | 0.12 |     | V/ $\mu\text{s}$       |
|             |  | Full range | 0.05                                   |      |     | 0.05      |      |     |                        |
| $V_n$       | Equivalent input noise voltage<br>$f = 10\text{ Hz}$<br>$f = 1\text{ kHz}$   | 25°C       | 36                                     |      |     | 36        |      |     | nV/ $\sqrt{\text{Hz}}$ |
|             |  | 25°C       | 19                                     |      |     | 19        |      |     |                        |
| $V_{N(PP)}$ | Peak-to-peak equivalent input noise voltage<br>$f = 0.1\text{ Hz to }1\text{ Hz}$<br>$f = 0.1\text{ Hz to }10\text{ Hz}$               | 25°C       | 0.7                                    |      |     | 0.7       |      |     | $\mu\text{V}$          |
|             |  | 25°C       | 1.1                                    |      |     | 1.1       |      |     |                        |
| $I_n$       | Equivalent input noise current   | 25°C       | 0.6                                    |      |     | 0.6       |      |     | fA/ $\sqrt{\text{Hz}}$ |
| THD + N     | Total harmonic distortion plus noise<br>$V_O = 0.5\text{ V to }2.5\text{ V}$ ,<br>$f = 20\text{ kHz}$ ,<br>$R_L = 50\text{ k}\Omega$ ‡ | 25°C       | $A_V = 1$                              |      |     | 0.2%      |      |     |                        |
|             |  |            | $A_V = 10$                             |      |     | 1%        |      |     |                        |
|             | Gain-bandwidth product<br>$f = 50\text{ kHz}$ ,<br>$C_L = 100\text{ pF}$ ‡   | 25°C       | $R_L = 50\text{ k}\Omega$ ‡            |      |     | 0.2       |      |     | MHz                    |
| BOM         | Maximum output-swing bandwidth<br>$V_{O(PP)} = 2\text{ V}$ ,<br>$R_L = 50\text{ k}\Omega$ ‡  | 25°C       | $A_V = 1$ ,<br>$C_L = 100\text{ pF}$ ‡ |      |     | 30        |      |     | kHz                    |
| $\phi_m$    | Phase margin at unity gain<br>$R_L = 50\text{ k}\Omega$ ‡  | 25°C       | $C_L = 100\text{ pF}$ ‡                |      |     | 63°       |      |     |                        |
|             | Gain margin  | 25°C       |  |      |     | 15        |      |     | dB                     |

† Full range is –40°C to 125°C.

‡ Referenced to 2.5 V

**TLC225x, TLC225xA**  
**Advanced LinCMOS™ RAIL-TO-RAIL**  
**VERY LOW-POWER OPERATIONAL AMPLIFIERS**

SLOS176D – FEBRUARY 1997 – REVISED MARCH 2001

**electrical characteristics at specified free-air temperature,  $V_{DD\pm} = \pm 5$  V (unless otherwise noted)**

| PARAMETER   | TEST CONDITIONS   | $T_A$ †                | TLC2254I   |             |      | TLC2254AI |             |                  | UNIT |
|---|---|------------------------|------------|-------------|------|-----------|-------------|------------------|------|
|   |   |                        | MIN        | TYP         | MAX  | MIN       | TYP         | MAX              |      |
| $V_{IO}$ Input offset voltage   | $V_{IC} = 0, V_O = 0, R_S = 50 \Omega$                              | 25°C                   | 200        | 1500        |      | 200       | 850         | $\mu V$          |      |
|   |   | Full range             |            |             | 1750 |           | 1000        |                  |      |
| $\alpha_{VIO}$ Temperature coefficient of input offset voltage                |   | 25°C to 125°C          | 0.5        |             |      | 0.5       |             | $\mu V/^\circ C$ |      |
| Input offset voltage long-term drift (see Note 4)                             |   | 25°C                   | 0.003      |             |      | 0.003     |             | $\mu V/mo$       |      |
| $I_{IO}$ Input offset current   |   | 25°C                   | 0.5        | 60          |      | 0.5       | 60          | $pA$             |      |
|   |   | Full range             |            |             | 1000 |           | 1000        |                  |      |
| $I_{IB}$ Input bias current   | 25°C  | 1                      | 60         |             | 1    | 60        | $pA$        |                  |      |
|   | Full range  |                        |            | 1000        |      | 1000      |             |                  |      |
| $V_{ICR}$ Common-mode input voltage range                                     | $R_S = 50 \Omega,  V_{IO}  \leq 5$ mV                               | 25°C                   | -5 to 4    | -5.3 to 4.2 |      | -5 to 4   | -5.3 to 4.2 | V                |      |
|   |   | Full range             | -5 to 3.5  |             |      | -5 to 3.5 |             |                  |      |
| $V_{OM+}$ Maximum positive peak output voltage                                | $I_O = -20 \mu A$   | 25°C                   | 4.98       |             |      | 4.98      | V           |                  |      |
|   | $I_O = -100 \mu A$  | 25°C                   | 4.9        | 4.93        |      | 4.9       |             | 4.93             |      |
|   |   | Full range             | 4.7        |             |      | 4.7       |             |                  |      |
|   | $I_O = -200 \mu A$  | 25°C                   | 4.8        | 4.86        |      | 4.8       |             | 4.86             |      |
| $V_{OM-}$ Maximum negative peak output voltage                                | $V_{IC} = 0, I_O = 50 \mu A$  | 25°C                   | -4.99      |             |      | -4.99     | V           |                  |      |
|   | $V_{IC} = 0, I_O = 500 \mu A$                                       | 25°C                   | -4.85      | -4.91       |      | -4.85     |             | -4.91            |      |
|   |   | Full range             | -4.85      |             |      | -4.85     |             |                  |      |
|   | $V_{IC} = 0, I_O = 4$ mA  | 25°C                   | -4         | -4.3        |      | -4        |             | -4.3             |      |
| $AVD$ Large-signal differential voltage amplification                         | $V_O = \pm 4$ V   | $R_L = 100$ k $\Omega$ | 25°C       | 40          | 150  |           | 40          | 150              | V/mV |
|   |   |                        | Full range | 10          |      |           | 10          |                  |      |
|   |   | $R_L = 1$ M $\Omega$   | 25°C       | 3000        |      |           | 3000        |                  |      |
| $r_{i(d)}$ Differential input resistance                                      |   | 25°C                   | $10^{12}$  |             |      | $10^{12}$ | $\Omega$    |                  |      |
| $r_{i(c)}$ Common-mode input resistance                                       |   | 25°C                   | $10^{12}$  |             |      | $10^{12}$ | $\Omega$    |                  |      |
| $C_{i(c)}$ Common-mode input capacitance                                      | $f = 10$ kHz, N package   | 25°C                   | 8          |             |      | 8         | pF          |                  |      |
| $z_o$ Closed-loop output impedance  | $f = 25$ kHz, $A_V = 10$  | 25°C                   | 190        |             |      | 190       | $\Omega$    |                  |      |
| CMRR Common-mode rejection ratio  | $V_{IC} = -5$ V to 2.7 V, $V_O = 0, R_S = 50 \Omega$                | 25°C                   | 75         | 88          |      | 75        | 88          | dB               |      |
|   |   | Full range             | 75         |             |      | 75        |             |                  |      |
| $k_{SVR}$ Supply-voltage rejection ratio ( $\Delta V_{DD\pm}/\Delta V_{IO}$ ) | $V_{DD\pm} = \pm 2.2$ V to $\pm 8$ V, $V_{IC} = V_{DD}/2$ , No load | 25°C                   | 80         | 95          |      | 80        | 95          | dB               |      |
|   |   | Full range             | 80         |             |      | 80        |             |                  |      |
| $I_{DD}$ Supply current (four amplifiers)                                     | $V_O = 0$ , No load   | 25°C                   | 160        | 250         |      | 160       | 250         | $\mu A$          |      |
|   |   | Full range             |            |             | 300  |           | 300         |                  |      |

† Full range is -40°C to 125°C.

NOTE 4: Typical values are based on the input offset voltage shift observed through 500 hours of operating life test at  $T_A = 150^\circ C$  extrapolated to  $T_A = 25^\circ C$  using the Arrhenius equation and assuming an activation energy of 0.96 eV.



**TLC225x, TLC225xA**  
**Advanced LinCMOS™ RAIL-TO-RAIL**  
**VERY LOW-POWER OPERATIONAL AMPLIFIERS**

SLOS176D – FEBRUARY 1997 – REVISED MARCH 2001

**operating characteristics at specified free-air temperature,  $V_{DD\pm} = \pm 5\text{ V}$**

| PARAMETER   | TEST CONDITIONS   | $T_A$ †    | TLC2254I |      |     | TLC2254AI |      |     | UNIT                   |
|-------------|---|------------|----------|------|-----|-----------|------|-----|------------------------|
|             |   |            | MIN      | TYP  | MAX | MIN       | TYP  | MAX |                        |
| SR          | Slew rate at unity gain<br>$V_O = \pm 1.9\text{ V}$ ,<br>$C_L = 100\text{ pF}$ ,<br>$R_L = 100\text{ k}\Omega$                        | 25°C       | 0.07     | 0.12 |     | 0.07      | 0.12 |     | V/ $\mu\text{s}$       |
|             |   | Full range | 0.05     |      |     | 0.05      |      |     |                        |
| $V_n$       | Equivalent input noise voltage  | 25°C       | 38       |      |     | 38        |      |     | nV/ $\sqrt{\text{Hz}}$ |
|             |   | 25°C       | 19       |      |     | 19        |      |     |                        |
| $V_{N(PP)}$ | Peak-to-peak equivalent input noise voltage   | 25°C       | 0.8      |      |     | 0.8       |      |     | $\mu\text{V}$          |
|             |   | 25°C       | 1.1      |      |     | 1.1       |      |     |                        |
| $I_n$       | Equivalent input noise current  | 25°C       | 0.6      |      |     | 0.6       |      |     | fA/ $\sqrt{\text{Hz}}$ |
| THD + N     | Total harmonic distortion plus noise<br>$V_O = \pm 2.3\text{ V}$ ,<br>$R_L = 50\text{ k}\Omega$ ,<br>$f = 20\text{ kHz}$              | 25°C       | 0.2%     |      |     | 0.2%      |      |     |                        |
|             |   |            | 1%       |      |     | 1%        |      |     |                        |
|             | Gain-bandwidth product<br>$f = 10\text{ kHz}$ ,<br>$C_L = 100\text{ pF}$ ,<br>$R_L = 50\text{ k}\Omega$                               | 25°C       | 0.21     |      |     | 0.21      |      |     | MHz                    |
| BOM         | Maximum output-swing bandwidth<br>$V_{O(PP)} = 4.6\text{ V}$ ,<br>$R_L = 50\text{ k}\Omega$ ,<br>$A_V = 1$ ,<br>$C_L = 100\text{ pF}$ | 25°C       | 14       |      |     | 14        |      |     | kHz                    |
| $\phi_m$    | Phase margin at unity gain<br>$R_L = 50\text{ k}\Omega$ ,<br>$C_L = 100\text{ pF}$  | 25°C       | 63°      |      |     | 63°       |      |     |                        |
|             |   | 25°C       | 15       |      |     | 15        |      |     |                        |

† Full range is  $-40^\circ\text{C}$  to  $125^\circ\text{C}$ .

# TLC225x, TLC225xA Advanced LinCMOS™ RAIL-TO-RAIL VERY LOW-POWER OPERATIONAL AMPLIFIERS

SLOS176D – FEBRUARY 1997 – REVISED MARCH 2001

electrical characteristics at specified free-air temperature,  $V_{DD} = 5\text{ V}$  (unless otherwise noted)

| PARAMETER  | TEST CONDITIONS  | $T_A$ †                      | TLC2252Q<br>TLC2252M |             |          | TLC2252AQ<br>TLC2252AM |             |               | UNIT                         |      |
|--|--|------------------------------|----------------------|-------------|----------|------------------------|-------------|---------------|------------------------------|------|
|  |  |                              | MIN                  | TYP         | MAX      | MIN                    | TYP         | MAX           |                              |      |
| $V_{IO}$ Input offset voltage  | $V_{DD\pm} = \pm 2.5\text{ V}$ ,<br>$V_O = 0$ ,<br>$V_{IC} = 0$ ,<br>$R_S = 50\ \Omega$                          | 25°C                         | 200                  | 1500        |          | 200                    | 850         | $\mu\text{V}$ |                              |      |
|  |  | Full range                   |                      |             | 1750     |                        | 1000        |               |                              |      |
| $\alpha_{VIO}$ Temperature coefficient of input offset voltage             |  | 25°C to 125°C                | 0.5                  |             |          | 0.5                    |             |               | $\mu\text{V}/^\circ\text{C}$ |      |
| Input offset voltage long-term drift (see Note 4)                          |  | 25°C                         | 0.003                |             |          | 0.003                  |             |               | $\mu\text{V}/\text{mo}$      |      |
| $I_{IO}$ Input offset current  |  | 25°C                         | 0.5                  | 60          |          | 0.5                    | 60          | $\text{pA}$   |                              |      |
|  |  | Full range                   |                      |             | 1000     |                        | 1000        |               |                              |      |
| $I_{IB}$ Input bias current  | 25°C   | 1                            | 60                   |             | 1        | 60                     | $\text{pA}$ |               |                              |      |
|  | Full range   |                              |                      | 1000        |          | 1000                   |             |               |                              |      |
| $V_{ICR}$ Common-mode input voltage range                                  | $R_S = 50\ \Omega$ ,<br>$ V_{IO}  \leq 5\text{ mV}$  | 25°C                         | 0 to 4               | -0.3 to 4.2 |          | 0 to 4                 | -0.3 to 4.2 | V             |                              |      |
|  |  | Full range                   | 0 to 3.5             |             | 0 to 3.5 |                        |             |               |                              |      |
| $V_{OH}$ High-level output voltage   | $I_{OH} = -20\ \mu\text{A}$<br>$I_{OH} = -75\ \mu\text{A}$<br>$I_{OH} = -150\ \mu\text{A}$                       | 25°C                         | 4.98                 |             |          | 4.98                   |             |               | V                            |      |
|  |  | 25°C                         | 4.9                  | 4.94        |          | 4.9                    | 4.94        |               |                              |      |
|  |  | Full range                   | 4.8                  |             |          | 4.8                    |             |               |                              |      |
|  |  | 25°C                         | 4.8                  | 4.88        |          | 4.8                    | 4.88        |               |                              |      |
| $V_{OL}$ Low-level output voltage  | $V_{IC} = 2.5\text{ V}$ ,<br>$I_{OL} = 50\ \mu\text{A}$<br>$I_{OL} = 500\ \mu\text{A}$<br>$I_{OL} = 4\text{ mA}$ | 25°C                         | 0.01                 |             |          | 0.01                   |             |               | V                            |      |
|  |  | 25°C                         | 0.09                 | 0.15        |          | 0.09                   | 0.15        |               |                              |      |
|  |  | Full range                   | 0.15                 |             |          | 0.15                   |             |               |                              |      |
|  |  | 25°C                         | 0.8                  | 1           |          | 0.7                    | 1           |               |                              |      |
|  |  | Full range                   | 1.2                  |             |          | 1.2                    |             |               |                              |      |
|  |  | 25°C                         | 100                  | 350         |          | 100                    | 350         |               |                              |      |
| $AVD$ Large-signal differential voltage amplification                      | $V_{IC} = 2.5\text{ V}$ ,<br>$V_O = 1\text{ V to }4\text{ V}$  | $R_L = 100\text{ k}\Omega$ ‡ | 25°C                 | 100         |          |                        | 100         |               |                              | V/mV |
|  |  |                              | Full range           | 10          |          |                        | 10          |               |                              |      |
|  |  | $R_L = 1\text{ M}\Omega$ ‡   | 25°C                 | 1700        |          |                        | 1700        |               |                              |      |
| $r_{id}$ Differential input resistance                                     |  | 25°C                         | $10^{12}$            |             |          | $10^{12}$              |             |               | $\Omega$                     |      |
| $r_{ic}$ Common-mode input resistance                                      |  | 25°C                         | $10^{12}$            |             |          | $10^{12}$              |             |               | $\Omega$                     |      |
| $c_{ic}$ Common-mode input capacitance                                     | $f = 10\text{ kHz}$ ,<br>$f = 10\text{ kHz}$   | 25°C                         | 8                    |             |          | 8                      |             |               | pF                           |      |
| $z_o$ Closed-loop output impedance   | $f = 25\text{ kHz}$ ,<br>$A_V = 10$  | 25°C                         | 200                  |             |          | 200                    |             |               | $\Omega$                     |      |
| CMRR Common-mode rejection ratio   | $V_{IC} = 0\text{ to }2.7\text{ V}$ ,<br>$R_S = 50\ \Omega$ ,<br>$V_O = 2.5\text{ V}$                            | 25°C                         | 70                   | 83          |          | 70                     | 83          | dB            |                              |      |
|  |  | Full range                   | 70                   |             |          | 70                     |             |               |                              |      |
| $k_{SVR}$ Supply-voltage rejection ratio ( $\Delta V_{DD}/\Delta V_{IO}$ ) | $V_{DD} = 4.4\text{ V to }16\text{ V}$ ,<br>$V_{IC} = V_{DD}/2$ ,<br>No load                                     | 25°C                         | 80                   | 95          |          | 80                     | 95          | dB            |                              |      |
|  |  | Full range                   | 80                   |             |          | 80                     |             |               |                              |      |
| $I_{DD}$ Supply current  | $V_O = 2.5\text{ V}$ ,<br>No load  | 25°C                         | 70                   | 125         |          | 70                     | 125         | $\mu\text{A}$ |                              |      |
|  |  | Full range                   | 150                  |             |          | 150                    |             |               |                              |      |

† Full range is  $-40^\circ\text{C}$  to  $125^\circ\text{C}$  for Q suffix,  $-55^\circ\text{C}$  to  $125^\circ\text{C}$  for M suffix.

‡ Referenced to 2.5 V

NOTE 4: Typical values are based on the input offset voltage shift observed through 500 hours of operating life test at  $T_A = 150^\circ\text{C}$  extrapolated to  $T_A = 25^\circ\text{C}$  using the Arrhenius equation and assuming an activation energy of 0.96 eV.



**TLC225x, TLC225xA**  
**Advanced LinCMOS™ RAIL-TO-RAIL**  
**VERY LOW-POWER OPERATIONAL AMPLIFIERS**

SLOS176D – FEBRUARY 1997 – REVISED MARCH 2001

**operating characteristics at specified free-air temperature,  $V_{DD} = 5\text{ V}$**

| PARAMETER   | TEST CONDITIONS  | $T_A$ †                           | TLC2252Q<br>TLC2252M |      |     | TLC2252AQ<br>TLC2252AM |      |     | UNIT                   |
|-------------|--|-----------------------------------|----------------------|------|-----|------------------------|------|-----|------------------------|
|             |  |                                   | MIN                  | TYP  | MAX | MIN                    | TYP  | MAX |                        |
| SR          | Slew rate at unity gain<br>$V_O = 0.5\text{ V to }3.5\text{ V}$ ,<br>$R_L = 100\text{ k}\Omega$ ‡, $C_L = 100\text{ pF}$ ‡             | 25°C                              | 0.07                 | 0.12 |     | 0.07                   | 0.12 |     | V/ $\mu$ s             |
|             |  | Full range                        | 0.05                 |      |     | 0.05                   |      |     |                        |
| $V_n$       | Equivalent input noise voltage<br>$f = 10\text{ Hz}$<br>$f = 1\text{ kHz}$   | 25°C                              | 36                   |      |     | 36                     |      |     | nV/ $\sqrt{\text{Hz}}$ |
|             |  | 25°C                              | 19                   |      |     | 19                     |      |     |                        |
| $V_{N(PP)}$ | Peak-to-peak equivalent input noise voltage<br>$f = 0.1\text{ Hz to }1\text{ Hz}$<br>$f = 0.1\text{ Hz to }10\text{ Hz}$               | 25°C                              | 0.7                  |      |     | 0.7                    |      |     | $\mu$ V                |
|             |  | 25°C                              | 1.1                  |      |     | 1.1                    |      |     |                        |
| $I_n$       | Equivalent input noise current   | 25°C                              | 0.6                  |      |     | 0.6                    |      |     | fA/ $\sqrt{\text{Hz}}$ |
| THD + N     | Total harmonic distortion plus noise<br>$V_O = 0.5\text{ V to }2.5\text{ V}$ ,<br>$f = 10\text{ kHz}$ ,<br>$R_L = 50\text{ k}\Omega$ ‡ | $A_V = 1$                         | 0.2%                 |      |     | 0.2%                   |      |     |                        |
|             |  | $A_V = 10$                        | 1%                   |      |     | 1%                     |      |     |                        |
|             | Gain-bandwidth product<br>$f = 50\text{ kHz}$ ,<br>$C_L = 100\text{ pF}$ ‡   | $R_L = 50\text{ k}\Omega$ ‡, 25°C | 0.2                  |      |     | 0.2                    |      |     | MHz                    |
| $B_{OM}$    | Maximum output-swing bandwidth<br>$V_{O(PP)} = 2\text{ V}$ ,<br>$R_L = 50\text{ k}\Omega$ ‡, $A_V = 1$ ,<br>$C_L = 100\text{ pF}$ ‡    | 25°C                              | 30                   |      |     | 30                     |      |     | kHz                    |
| $\phi_m$    | Phase margin at unity gain<br>$R_L = 50\text{ k}\Omega$ ‡, $C_L = 100\text{ pF}$ ‡   | 25°C                              | 63°                  |      |     | 63°                    |      |     |                        |
|             |  | 25°C                              | 15                   |      |     | 15                     |      |     | dB                     |

† Full range is – 40°C to 125°C for Q suffix, – 55°C to 125°C for M suffix.

‡ Referenced to 2.5 V

**TLC225x, TLC225xA**  
**Advanced LinCMOS™ RAIL-TO-RAIL**  
**VERY LOW-POWER OPERATIONAL AMPLIFIERS**

SLOS176D – FEBRUARY 1997 – REVISED MARCH 2001

**electrical characteristics at specified free-air temperature,  $V_{DD\pm} = \pm 5$  V (unless otherwise noted)**

| PARAMETER   | TEST CONDITIONS  | $T_A$ †             | TLC2252Q<br>TLC2252M |             |      | TLC2252AQ<br>TLC2252AM |             |                  | UNIT |
|---|--|---------------------|----------------------|-------------|------|------------------------|-------------|------------------|------|
|   |  |                     | MIN                  | TYP         | MAX  | MIN                    | TYP         | MAX              |      |
| $V_{IO}$ Input offset voltage   | $V_{IC} = 0, V_O = 0, R_S = 50 \Omega$                 | 25°C                | 200                  | 1500        |      | 200                    | 850         | $\mu V$          |      |
|   |  | Full range          |                      |             | 1750 |                        | 1000        |                  |      |
| $\alpha V_{IO}$ Temperature coefficient of input offset voltage                 |  | 25°C to 125°C       | 0.5                  |             |      | 0.5                    |             | $\mu V/^\circ C$ |      |
| Input offset voltage long-term drift (see Note 4)                               |  | 25°C                | 0.003                |             |      | 0.003                  |             | $\mu V/mo$       |      |
| $I_{IO}$ Input offset current   |  | 25°C                | 0.5                  | 60          |      | 0.5                    | 60          | $pA$             |      |
|   |  | Full range          |                      |             | 1000 |                        | 1000        |                  |      |
| $I_{IB}$ Input bias current   | 25°C   | 1                   | 60                   |             | 1    | 60                     | $pA$        |                  |      |
|   | Full range   |                     |                      | 1000        |      | 1000                   |             |                  |      |
| $V_{ICR}$ Common-mode input voltage range                                       | $R_S = 50 \Omega,  V_{IO}  \leq 5 mV$                  | 25°C                | -5 to 4              | -5.3 to 4.2 |      | -5 to 4                | -5.3 to 4.2 | V                |      |
|   |  | Full range          | -5 to 3.5            |             |      | -5 to 3.5              |             |                  |      |
| $V_{OM+}$ Maximum positive peak output voltage                                  | $I_O = -20 \mu A$                                      | 25°C                | 4.98                 |             |      | 4.98                   | V           |                  |      |
|   | $I_O = -100 \mu A$                                     | 25°C                | 4.9                  | 4.93        |      | 4.9                    |             | 4.93             |      |
|   |  | Full range          | 4.7                  |             |      | 4.7                    |             |                  |      |
|   | $I_O = -200 \mu A$                                     | 25°C                | 4.8                  | 4.86        |      | 4.8                    |             | 4.86             |      |
| $V_{OM-}$ Maximum negative peak output voltage                                  | $V_{IC} = 0, I_O = 50 \mu A$                           | 25°C                | -4.99                |             |      | -4.99                  | V           |                  |      |
|   | $V_{IC} = 0, I_O = 500 \mu A$                          | 25°C                | -4.85                | -4.91       |      | -4.85                  |             | -4.91            |      |
|   |  | Full range          | -4.85                |             |      | -4.85                  |             |                  |      |
|   | $V_{IC} = 0, I_O = 4 mA$                               | 25°C                | -4                   | -4.3        |      | -4                     |             | -4.3             |      |
|   |  | Full range          | -3.8                 |             |      | -3.8                   |             |                  |      |
| $AVD$ Large-signal differential voltage amplification                           | $V_O = \pm 4 V$  | $R_L = 100 k\Omega$ | 25°C                 | 40          | 150  |                        | 40          | 150              | V/mV |
|   |  |                     | Full range           | 10          |      |                        | 10          |                  |      |
|   |  | $R_L = 1 M\Omega$   | 25°C                 | 3000        |      |                        | 3000        |                  |      |
| $r_{id}$ Differential input resistance  |  | 25°C                | $10^{12}$            |             |      | $10^{12}$              | $\Omega$    |                  |      |
| $r_{ic}$ Common-mode input resistance   |  | 25°C                | $10^{12}$            |             |      | $10^{12}$              | $\Omega$    |                  |      |
| $c_{ic}$ Common-mode input capacitance  | $f = 10 kHz, P$ package                                | 25°C                | 8                    |             |      | 8                      | pF          |                  |      |
| $z_o$ Closed-loop output impedance  | $f = 25 kHz, A_V = 10$                                 | 25°C                | 190                  |             |      | 190                    | $\Omega$    |                  |      |
| CMRR Common-mode rejection ratio  | $V_{IC} = -5 V$ to 2.7 V, $V_O = 0, R_S = 50 \Omega$   | 25°C                | 75                   | 88          |      | 75                     | 88          | dB               |      |
|   |  | Full range          | 75                   |             |      | 75                     |             |                  |      |
| $k_{SVR}$ Supply-voltage rejection ratio ( $\Delta V_{DD\pm} / \Delta V_{IO}$ ) | $V_{DD} = \pm 2.2 V$ to $\pm 8 V, V_{IC} = 0, No$ load | 25°C                | 80                   | 95          |      | 80                     | 95          | dB               |      |
|   |  | Full range          | 80                   |             |      | 80                     |             |                  |      |
| $I_{DD}$ Supply current   | $V_O = 2.5 V, No$ load                                 | 25°C                | 80                   | 125         |      | 80                     | 125         | $\mu A$          |      |
|   |  | Full range          |                      |             | 150  |                        | 150         |                  |      |

† Full range is -40°C to 125°C for Q suffix, -55°C to 125°C for M suffix.

NOTE 4: Typical values are based on the input offset voltage shift observed through 500 hours of operating life test at  $T_A = 150^\circ C$  extrapolated to  $T_A = 25^\circ C$  using the Arrhenius equation and assuming an activation energy of 0.96 eV.





**TLC225x, TLC225xA**  
**Advanced LinCMOS™ RAIL-TO-RAIL**  
**VERY LOW-POWER OPERATIONAL AMPLIFIERS**

SLOS176D – FEBRUARY 1997 – REVISED MARCH 2001

**operating characteristics at specified free-air temperature,  $V_{DD\pm} = \pm 5\text{ V}$**

| PARAMETER   | TEST CONDITIONS   | $T_A$ †    | TLC2252Q<br>TLC2252M |      |     | TLC2252AQ<br>TLC2252AM |      |                        | UNIT                   |
|---|---|------------|----------------------|------|-----|------------------------|------|------------------------|------------------------|
|   |   |            | MIN                  | TYP  | MAX | MIN                    | TYP  | MAX                    |                        |
| SR Slew rate at unity gain                              | $V_O = \pm 2\text{ V}$ ,<br>$C_L = 100\text{ pF}$ ,<br>$R_L = 100\text{ k}\Omega$                   | 25°C       | 0.07                 | 0.12 |     | 0.07                   | 0.12 |                        | V/ $\mu\text{s}$       |
|   |   | Full range | 0.05                 |      |     | 0.05                   |      |                        |                        |
| $V_n$ Equivalent input noise voltage                    | $f = 10\text{ Hz}$<br>$f = 1\text{ kHz}$  | 25°C       |                      | 38   |     |                        | 38   |                        | nV/ $\sqrt{\text{Hz}}$ |
|   |   | 25°C       |                      | 19   |     |                        | 19   |                        |                        |
| $V_{N(PP)}$ Peak-to-peak equivalent input noise voltage | $f = 0.1\text{ Hz to }1\text{ Hz}$<br>$f = 0.1\text{ Hz to }10\text{ Hz}$                           | 25°C       |                      | 0.8  |     |                        | 0.8  |                        | $\mu\text{V}$          |
|   |   | 25°C       |                      | 1.1  |     |                        | 1.1  |                        |                        |
| $I_n$ Equivalent input noise current                    |   | 25°C       |                      | 0.6  |     |                        | 0.6  | fA/ $\sqrt{\text{Hz}}$ |                        |
| THD + N Total harmonic distortion plus noise            | $V_O = \pm 2.3\text{ V}$ ,<br>$R_L = 50\text{ k}\Omega$ ,<br>$f = 10\text{ kHz}$                    | 25°C       | $A_V = 1$            |      |     | 0.2%                   |      |                        |                        |
|   |   |            | $A_V = 10$           |      |     | 1%                     |      |                        |                        |
| Gain-bandwidth product                                  | $f = 10\text{ kHz}$ ,<br>$C_L = 100\text{ pF}$ ,<br>$R_L = 50\text{ k}\Omega$                       | 25°C       |                      | 0.21 |     |                        | 0.21 | MHz                    |                        |
| BOM Maximum output-swing bandwidth                      | $V_{O(PP)} = 4.6\text{ V}$ ,<br>$R_L = 50\text{ k}\Omega$ ,<br>$A_V = 1$ ,<br>$C_L = 100\text{ pF}$ | 25°C       |                      | 14   |     |                        | 14   | kHz                    |                        |
| $\phi_m$ Phase margin at unity gain<br>Gain margin      | $R_L = 50\text{ k}\Omega$ ,<br>$C_L = 100\text{ pF}$  | 25°C       |                      | 63°  |     |                        | 63°  |                        |                        |
|   |   | 25°C       |                      | 15   |     |                        | 15   | dB                     |                        |

† Full range is – 40°C to 125°C for Q suffix, – 55°C to 125°C for M suffix.

# TLC225x, TLC225xA Advanced LinCMOS™ RAIL-TO-RAIL VERY LOW-POWER OPERATIONAL AMPLIFIERS

SLOS176D – FEBRUARY 1997 – REVISED MARCH 2001

electrical characteristics at specified free-air temperature,  $V_{DD} = 5\text{ V}$  (unless otherwise noted)

| PARAMETER  | TEST CONDITIONS   | $T_A$ †  | TLC2254Q<br>TLC2254M         |             |          | TLC2254AQ<br>TLC2254AM |             |               | UNIT                         |
|--|---|--|------------------------------|-------------|----------|------------------------|-------------|---------------|------------------------------|
|  |   |  | MIN                          | TYP         | MAX      | MIN                    | TYP         | MAX           |                              |
| $V_{IO}$ Input offset voltage  |   | 25°C   | 200                          | 1500        |          | 200                    | 850         | $\mu\text{V}$ |                              |
|  |   | Full range   |                              | 1750        |          | 1000                   |             |               |                              |
| $\alpha_{VIO}$ Temperature coefficient of input offset voltage             |   | 25°C to 125°C  | 0.5                          |             |          | 0.5                    |             |               | $\mu\text{V}/^\circ\text{C}$ |
| Input offset voltage long-term drift (see Note 4)                          | $V_{DD\pm} = \pm 2.5\text{ V}$ , $V_{IC} = 0$ , $V_O = 0$ , $R_S = 50\ \Omega$  | 25°C   | 0.003                        |             |          | 0.003                  |             |               | $\mu\text{V}/\text{mo}$      |
| $I_{IO}$ Input offset current  |   | 25°C   | 0.5                          | 60          |          | 0.5                    | 60          | pA            |                              |
|  |   | 125°C  | 1000                         |             |          | 1000                   |             |               |                              |
| $I_{IB}$ Input bias current  |   | 25°C   | 1                            | 60          |          | 1                      | 60          | pA            |                              |
|  | 125°C   | 1000   |                              |             | 1000     |                        |             |               |                              |
| $V_{ICR}$ Common-mode input voltage range                                  | $R_S = 50\ \Omega$ , $ V_{IO}  \leq 5\text{ mV}$                                | 25°C   | 0 to 4                       | -0.3 to 4.2 |          | 0 to 4                 | -0.3 to 4.2 | V             |                              |
|  |   | Full range   | 0 to 3.5                     |             | 0 to 3.5 |                        |             |               |                              |
| $V_{OH}$ High-level output voltage   | $I_{OH} = -20\ \mu\text{A}$   | 25°C   | 4.98                         |             |          | 4.98                   |             |               | V                            |
|  | $I_{OH} = -75\ \mu\text{A}$   | 25°C   | 4.9                          | 4.94        |          | 4.9                    | 4.94        |               |                              |
|  | Full range  | 4.8  |                              |             | 4.8      |                        |             |               |                              |
|  | $I_{OH} = -150\ \mu\text{A}$  | 25°C   | 4.8                          | 4.88        |          | 4.8                    | 4.88        |               |                              |
| $V_{OL}$ Low-level output voltage  | $V_{IC} = 2.5\text{ V}$ , $I_{OL} = 50\ \mu\text{A}$                            | 25°C   | 0.01                         |             |          | 0.01                   |             |               | V                            |
|  | $V_{IC} = 2.5\text{ V}$ , $I_{OL} = 500\ \mu\text{A}$                           | 25°C   | 0.09                         | 0.15        |          | 0.09                   | 0.15        |               |                              |
|  |   | Full range   | 0.15                         |             |          | 0.15                   |             |               |                              |
|  | $V_{IC} = 2.5\text{ V}$ , $I_{OL} = 4\text{ mA}$                                | 25°C   | 0.8                          | 1           |          | 0.7                    | 1           |               |                              |
|  |   | Full range   | 1.2                          |             |          | 1.2                    |             |               |                              |
|  | $A_{VD}$ Large-signal differential voltage amplification                        | $V_{IC} = 2.5\text{ V}$ , $V_O = 1\text{ V to }4\text{ V}$ | $R_L = 100\text{ k}\Omega$ ‡ | 25°C        | 100      | 350                    |             | 100           |                              |
| Full range   |   |  | 10                           |             |          | 10                     |             |               |                              |
| $R_L = 1\text{ M}\Omega$ ‡   |   |  | 25°C                         | 1700        |          |                        | 1700        |               |                              |
| $r_{i(d)}$ Differential input resistance                                   |   | 25°C   | 1012                         |             |          | 1012                   |             |               | $\Omega$                     |
| $r_{i(c)}$ Common-mode input resistance                                    |   | 25°C   | 1012                         |             |          | 1012                   |             |               | $\Omega$                     |
| $C_{i(c)}$ Common-mode input capacitance                                   | $f = 10\text{ kHz}$ , N package   | 25°C   | 8                            |             |          | 8                      |             |               | pF                           |
| $z_o$ Closed-loop output impedance   | $f = 25\text{ kHz}$ , $A_V = 10$  | 25°C   | 200                          |             |          | 200                    |             |               | $\Omega$                     |
| CMRR Common-mode rejection ratio   | $V_{IC} = 0\text{ to }2.7\text{ V}$ , $V_O = 2.5\text{ V}$ , $R_S = 50\ \Omega$ | 25°C   | 70                           | 83          |          | 70                     | 83          | dB            |                              |
|  |   | Full range   | 70                           |             |          | 70                     |             |               |                              |
| $k_{SVR}$ Supply-voltage rejection ratio ( $\Delta V_{DD}/\Delta V_{IO}$ ) | $V_{DD} = 4.4\text{ V to }16\text{ V}$ , $V_{IC} = V_{DD}/2$ , No load          | 25°C   | 80                           | 95          |          | 80                     | 95          | dB            |                              |
|  |   | Full range   | 80                           |             |          | 80                     |             |               |                              |
| $I_{DD}$ Supply current (four amplifiers)                                  | $V_O = 2.5\text{ V}$ , No load  | 25°C   | 140                          | 250         |          | 140                    | 250         | $\mu\text{A}$ |                              |
|  |   | Full range   | 300                          |             |          | 300                    |             |               |                              |

† Full range is  $-40^\circ\text{C}$  to  $125^\circ\text{C}$  for Q suffix,  $-55^\circ\text{C}$  to  $125^\circ\text{C}$  for M suffix.

‡ Referenced to 2.5 V

NOTE 4: Typical values are based on the input offset voltage shift observed through 500 hours of operating life test at  $T_A = 150^\circ\text{C}$  extrapolated to  $T_A = 25^\circ\text{C}$  using the Arrhenius equation and assuming an activation energy of 0.96 eV.



**TLC225x, TLC225xA**  
**Advanced LinCMOS™ RAIL-TO-RAIL**  
**VERY LOW-POWER OPERATIONAL AMPLIFIERS**

SLOS176D – FEBRUARY 1997 – REVISED MARCH 2001

**operating characteristics at specified free-air temperature,  $V_{DD} = 5\text{ V}$**

| PARAMETER   | TEST CONDITIONS  | $T_A$ †                                      | TLC2254Q<br>TLC2254M |      |     | TLC2254AQ<br>TLC2254AM |      |     | UNIT                   |
|-------------|--|--|----------------------|------|-----|------------------------|------|-----|------------------------|
|             |  |  | MIN                  | TYP  | MAX | MIN                    | TYP  | MAX |                        |
| SR          | Slew rate at unity gain<br>$V_O = 0.5\text{ V to }3.5\text{ V}$ ,<br>$R_L = 100\text{ k}\Omega$ ‡,<br>$C_L = 100\text{ pF}$ ‡          | 25°C   | 0.07                 | 0.12 |     | 0.07                   | 0.12 |     | V/ $\mu$ s             |
|             |  | Full range                                   | 0.05                 |      |     | 0.05                   |      |     |                        |
| $V_n$       | Equivalent input noise voltage   | $f = 10\text{ Hz}$                           | 36                   |      |     | 36                     |      |     | nV/ $\sqrt{\text{Hz}}$ |
|             |  | $f = 1\text{ kHz}$                           | 19                   |      |     | 19                     |      |     |                        |
| $V_{N(PP)}$ | Peak-to-peak equivalent input noise voltage  | $f = 0.1\text{ Hz to }1\text{ Hz}$           | 0.7                  |      |     | 0.7                    |      |     | $\mu$ V                |
|             |  | $f = 0.1\text{ Hz to }10\text{ Hz}$          | 1.1                  |      |     | 1.1                    |      |     |                        |
| $I_n$       | Equivalent input noise current   | 25°C   | 0.6                  |      |     | 0.6                    |      |     | fA/ $\sqrt{\text{Hz}}$ |
| THD + N     | Total harmonic distortion plus noise<br>$V_O = 0.5\text{ V to }2.5\text{ V}$ ,<br>$f = 20\text{ kHz}$ ,<br>$R_L = 50\text{ k}\Omega$ ‡ | $A_V = 1$                                    | 0.2%                 |      |     | 0.2%                   |      |     |                        |
|             |  | $A_V = 10$                                   | 1%                   |      |     | 1%                     |      |     |                        |
|             | Gain-bandwidth product<br>$f = 50\text{ kHz}$ ,<br>$C_L = 100\text{ pF}$ ‡   | $R_L = 50\text{ k}\Omega$ ‡, 25°C            | 0.2                  |      |     | 0.2                    |      |     | MHz                    |
| $B_{OM}$    | Maximum output-swing bandwidth<br>$V_{O(PP)} = 2\text{ V}$ ,<br>$R_L = 50\text{ k}\Omega$ ‡  | $A_V = 1$ ,<br>$C_L = 100\text{ pF}$ ‡, 25°C | 30                   |      |     | 30                     |      |     | kHz                    |
| $\phi_m$    | Phase margin at unity gain<br>$R_L = 50\text{ k}\Omega$ ‡, $C_L = 100\text{ pF}$ ‡   | 25°C   | 63°                  |      |     | 63°                    |      |     |                        |
|             |  | 25°C   | 15                   |      |     | 15                     |      |     | dB                     |

† Full range is – 40°C to 125°C for Q suffix, – 55°C to 125°C for M suffix.

‡ Referenced to 2.5 V

**TLC225x, TLC225xA**  
**Advanced LinCMOS™ RAIL-TO-RAIL**  
**VERY LOW-POWER OPERATIONAL AMPLIFIERS**

SLOS176D – FEBRUARY 1997 – REVISED MARCH 2001

**electrical characteristics at specified free-air temperature,  $V_{DD\pm} = \pm 5$  V (unless otherwise noted)**

| PARAMETER   | TEST CONDITIONS  | $T_A$ †             | TLC2254Q<br>TLC2254M |             |      | TLC2254AQ<br>TLC2254AM |             |                  | UNIT |
|---|--|---------------------|----------------------|-------------|------|------------------------|-------------|------------------|------|
|   |  |                     | MIN                  | TYP         | MAX  | MIN                    | TYP         | MAX              |      |
| $V_{IO}$ Input offset voltage   | $V_{IC} = 0, V_O = 0, R_S = 50 \Omega$                           | 25°C                | 200                  | 1500        |      | 200                    | 850         | $\mu V$          |      |
|   |  | Full range          |                      |             | 1750 |                        | 1000        |                  |      |
| $\alpha V_{IO}$ Temperature coefficient of input offset voltage                 |  | 25°C to 125°C       | 0.5                  |             |      | 0.5                    |             | $\mu V/^\circ C$ |      |
| Input offset voltage long-term drift (see Note 4)                               |  | 25°C                | 0.003                |             |      | 0.003                  |             | $\mu V/mo$       |      |
| $I_{IO}$ Input offset current   |  | 25°C                | 0.5                  | 60          |      | 0.5                    | 60          | $pA$             |      |
|   |  | 125°C               |                      | 1000        |      | 1000                   |             |                  |      |
| $I_{IB}$ Input bias current   | 25°C   | 1                   | 60                   |             | 1    | 60                     | $pA$        |                  |      |
|   | 125°C  |                     | 1000                 |             | 1000 |                        |             |                  |      |
| $V_{ICR}$ Common-mode input voltage range                                       | $R_S = 50 \Omega,  V_{IO}  \leq 5 mV$                            | 25°C                | -5 to 4              | -5.3 to 4.2 |      | -5 to 4                | -5.3 to 4.2 | V                |      |
|   |  | Full range          | -5 to 3.5            |             |      | -5 to 3.5              |             |                  |      |
| $V_{OM+}$ Maximum positive peak output voltage                                  | $I_O = -20 \mu A$  | 25°C                | 4.98                 |             |      | 4.98                   | V           |                  |      |
|   | $I_O = -100 \mu A$   | 25°C                | 4.9                  | 4.93        |      | 4.9                    |             | 4.93             |      |
|   |  | Full range          | 4.7                  |             |      | 4.7                    |             |                  |      |
| $V_{OM-}$ Maximum negative peak output voltage                                  | $V_{IC} = 0, I_O = 50 \mu A$                                     | 25°C                | -4.99                |             |      | -4.99                  | V           |                  |      |
|   | $V_{IC} = 0, I_O = 500 \mu A$                                    | 25°C                | -4.85                | -4.91       |      | -4.85                  |             | -4.91            |      |
|   |  | Full range          | -4.85                |             |      | -4.85                  |             |                  |      |
|   | $V_{IC} = 0, I_O = 4 mA$   | 25°C                | -4                   | -4.3        |      | -4                     |             | -4.3             |      |
|   |  | Full range          | -3.8                 |             |      | -3.8                   |             |                  |      |
| $A_{VD}$ Large-signal differential voltage amplification                        | $V_O = \pm 4 V$  | $R_L = 100 k\Omega$ | 25°C                 | 40          | 150  |                        | 40          | 150              | V/mV |
|   |  |                     | Full range           | 10          |      |                        | 10          |                  |      |
|   |  | $R_L = 1 M\Omega$   | 25°C                 | 3000        |      |                        | 3000        |                  |      |
| $r_{i(d)}$ Differential input resistance  |  | 25°C                | 10 <sup>12</sup>     |             |      | 10 <sup>12</sup>       | $\Omega$    |                  |      |
| $r_{i(c)}$ Common-mode input resistance   |  | 25°C                | 10 <sup>12</sup>     |             |      | 10 <sup>12</sup>       | $\Omega$    |                  |      |
| $C_{i(c)}$ Common-mode input capacitance  | $f = 10 kHz, N$ package  | 25°C                | 8                    |             |      | 8                      | pF          |                  |      |
| $z_o$ Closed-loop output impedance  | $f = 25 kHz, A_V = 10$   | 25°C                | 190                  |             |      | 190                    | $\Omega$    |                  |      |
| CMRR Common-mode rejection ratio  | $V_{IC} = -5 V$ to 2.7 V, $V_O = 0, R_S = 50 \Omega$             | 25°C                | 75                   | 88          |      | 75                     | 88          | dB               |      |
|   |  | Full range          | 75                   |             |      | 75                     |             |                  |      |
| $k_{SVR}$ Supply-voltage rejection ratio ( $\Delta V_{DD\pm} / \Delta V_{IO}$ ) | $V_{DD\pm} = \pm 2.2 V$ to $\pm 8 V, V_{IC} = V_{DD}/2, No load$ | 25°C                | 80                   | 95          |      | 80                     | 95          | dB               |      |
|   |  | Full range          | 80                   |             |      | 80                     |             |                  |      |
| $I_{DD}$ Supply current (four amplifiers)                                       | $V_O = 0, No load$   | 25°C                | 160                  | 250         |      | 160                    | 250         | $\mu A$          |      |
|   |  | Full range          |                      | 300         |      |                        | 300         |                  |      |

† Full range is -40°C to 125°C for Q suffix, -55°C to 125°C for M suffix.

NOTE 4: Typical values are based on the input offset voltage shift observed through 500 hours of operating life test at  $T_A = 150^\circ C$  extrapolated to  $T_A = 25^\circ C$  using the Arrhenius equation and assuming an activation energy of 0.96 eV.



**TLC225x, TLC225xA**  
**Advanced LinCMOS™ RAIL-TO-RAIL**  
**VERY LOW-POWER OPERATIONAL AMPLIFIERS**

SLOS176D – FEBRUARY 1997 – REVISED MARCH 2001

**operating characteristics at specified free-air temperature,  $V_{DD\pm} = \pm 5\text{ V}$**

| PARAMETER   | TEST CONDITIONS  |                                      | $T_A$ †     | TLC2254Q<br>TLC2254M |      |     | TLC2254AQ<br>TLC2254AM |      |     | UNIT                   |
|---|--|--------------------------------------|-------------|----------------------|------|-----|------------------------|------|-----|------------------------|
|   |  |                                      |             | MIN                  | TYP  | MAX | MIN                    | TYP  | MAX |                        |
| SR Slew rate at unity gain                              | $V_O = \pm 2\text{ V}$ ,<br>$C_L = 100\text{ pF}$                                | $R_L = 100\text{ k}\Omega$           | 25°C        | 0.07                 | 0.12 |     | 0.07                   | 0.12 |     | V/ $\mu$ s             |
|   |  |                                      | Full range  | 0.05                 |      |     | 0.05                   |      |     |                        |
| $V_n$ Equivalent input noise voltage                    | $f = 10\text{ Hz}$   |                                      | 25°C        | 38                   |      |     | 38                     |      |     | nV/ $\sqrt{\text{Hz}}$ |
|   | $f = 1\text{ kHz}$   |                                      | 25°C        | 19                   |      |     | 19                     |      |     |                        |
| $V_{N(PP)}$ Peak-to-peak equivalent input noise voltage | $f = 0.1\text{ Hz to }1\text{ Hz}$   |                                      | 25°C        | 0.8                  |      |     | 0.8                    |      |     | $\mu$ V                |
|   | $f = 0.1\text{ Hz to }10\text{ Hz}$  |                                      | 25°C        | 1.1                  |      |     | 1.1                    |      |     |                        |
| $I_n$ Equivalent input noise current                    |  |                                      | 25°C        | 0.6                  |      |     | 0.6                    |      |     | fA/ $\sqrt{\text{Hz}}$ |
| THD + N Total harmonic distortion plus noise            | $V_O = \pm 2.3\text{ V}$ ,<br>$R_L = 50\text{ k}\Omega$ ,<br>$f = 20\text{ kHz}$ | $A_V = 1$                            | 25°C        | 0.2%                 |      |     | 0.2%                   |      |     |                        |
|   |  | $A_V = 10$                           |             | 1%                   |      |     | 1%                     |      |     |                        |
| Gain-bandwidth product                                  | $f = 10\text{ kHz}$ ,<br>$C_L = 100\text{ pF}$                                   | $R_L = 50\text{ k}\Omega$            | 25°C        | 0.21                 |      |     | 0.21                   |      |     | MHz                    |
| $B_{OM}$ Maximum output-swing bandwidth                 | $V_{O(PP)} = 4.6\text{ V}$ ,<br>$R_L = 50\text{ k}\Omega$                        | $A_V = 1$ ,<br>$C_L = 100\text{ pF}$ | 25°C        | 14                   |      |     | 14                     |      |     | kHz                    |
| $\phi_m$ Phase margin at unity gain                     | $R_L = 50\text{ k}\Omega$  | $C_L = 100\text{ pF}$                | 25°C        | 63°                  |      |     | 63°                    |      |     |                        |
|   |  |                                      | Gain margin | 25°C                 | 15   |     |                        | 15   |     |                        |

† Full range is – 40°C to 125°C for Q suffix, – 55°C to 125°C for M suffix.

**TLC225x, TLC225xA**  
**Advanced LinCMOS™ RAIL-TO-RAIL**  
**VERY LOW-POWER OPERATIONAL AMPLIFIERS**

SLOS176D – FEBRUARY 1997 – REVISED MARCH 2001

**TYPICAL CHARACTERISTICS**

**Table of Graphs**

|                 |   | <b>FIGURE</b>                                  |                  |
|-----------------|---|--|------------------|
| $V_{IO}$        | Input offset voltage                            | Distribution<br>vs Common-mode input voltage   | 2 – 5<br>6, 7    |
| $\alpha V_{IO}$ | Input offset voltage temperature coefficient    | Distribution                                   | 8 – 11           |
| $I_{IB}/I_{IO}$ | Input bias and input offset currents            | vs Free-air temperature                        | 12               |
| $V_I$           | Input voltage range                             | vs Supply voltage<br>vs Free-air temperature   | 13<br>14         |
| $V_{OH}$        | High-level output voltage                       | vs High-level output current                   | 15               |
| $V_{OL}$        | Low-level output voltage                        | vs Low-level output current                    | 16, 17           |
| $V_{OM+}$       | Maximum positive peak output voltage            | vs Output current                              | 18               |
| $V_{OM-}$       | Maximum negative peak output voltage            | vs Output current                              | 19               |
| $V_{O(PP)}$     | Maximum peak-to-peak output voltage             | vs Frequency                                   | 20               |
| $I_{OS}$        | Short-circuit output current                    | vs Supply voltage<br>vs Free-air temperature   | 21<br>22         |
| $V_O$           | Output voltage                                  | vs Differential input voltage                  | 23, 24           |
|                 | Differential gain                               | vs Load resistance                             | 25               |
| $A_{VD}$        | Large-signal differential voltage amplification | vs Frequency<br>vs Free-air temperature        | 26, 27<br>28, 29 |
| $z_o$           | Output impedance                                | vs Frequency                                   | 30, 31           |
| CMRR            | Common-mode rejection ratio                     | vs Frequency<br>vs Free-air temperature        | 32<br>33         |
| $k_{SVR}$       | Supply-voltage rejection ratio                  | vs Frequency<br>vs Free-air temperature        | 34, 35<br>36     |
| $I_{DD}$        | Supply current                                  | vs Supply voltage<br>vs Free-air temperature   | 37<br>38         |
| SR              | Slew rate                                       | vs Load capacitance<br>vs Free-air temperature | 39<br>40         |
| $V_O$           | Inverting large-signal pulse response           |  | 41, 42           |
| $V_O$           | Voltage-follower large-signal pulse response    |  | 43, 44           |
| $V_O$           | Inverting small-signal pulse response           |  | 45, 46           |
| $V_O$           | Voltage-follower small-signal pulse response    |  | 47, 48           |
| $V_n$           | Equivalent input noise voltage                  | vs Frequency                                   | 49, 50           |
|                 | Noise voltage (referred to input)               | Over a 10-second period                        | 51               |
|                 | Integrated noise voltage                        | vs Frequency                                   | 52               |
| THD + N         | Total harmonic distortion plus noise            | vs Frequency                                   | 53               |
|                 | Gain-bandwidth product                          | vs Free-air temperature<br>vs Supply voltage   | 54<br>55         |
| $\phi_m$        | Phase margin                                    | vs Frequency<br>vs Load capacitance            | 26, 27<br>56     |
| $A_m$           | Gain margin                                     | vs Load capacitance                            | 57               |
| $B_1$           | Unity-gain bandwidth                            | vs Load capacitance                            | 58               |
|                 | Overestimation of phase margin                  | vs Load capacitance                            | 59               |



**TYPICAL CHARACTERISTICS**

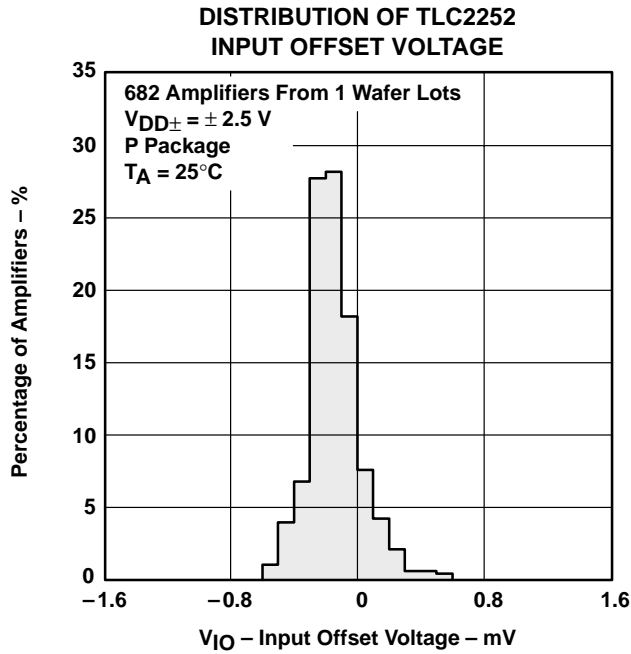

**Figure 2**

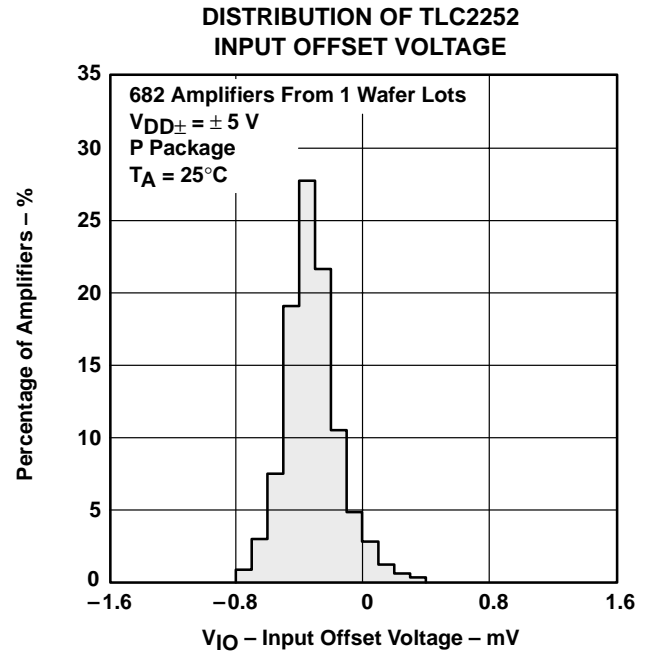

**Figure 3**

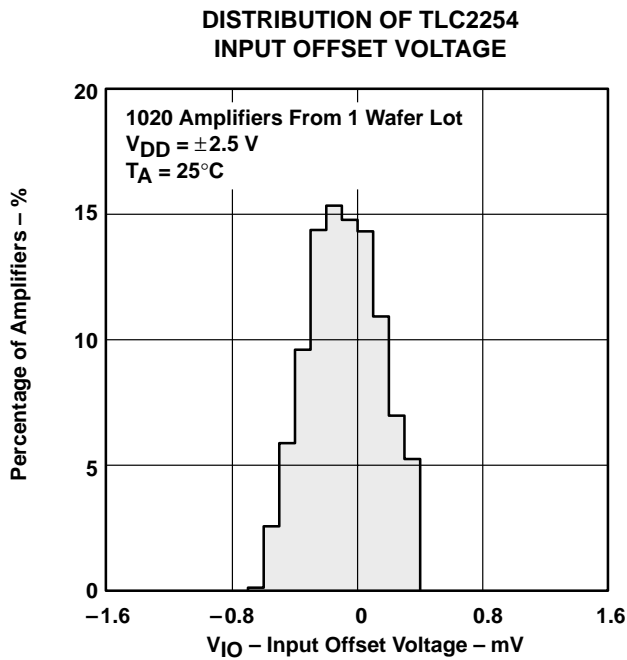

**Figure 4**

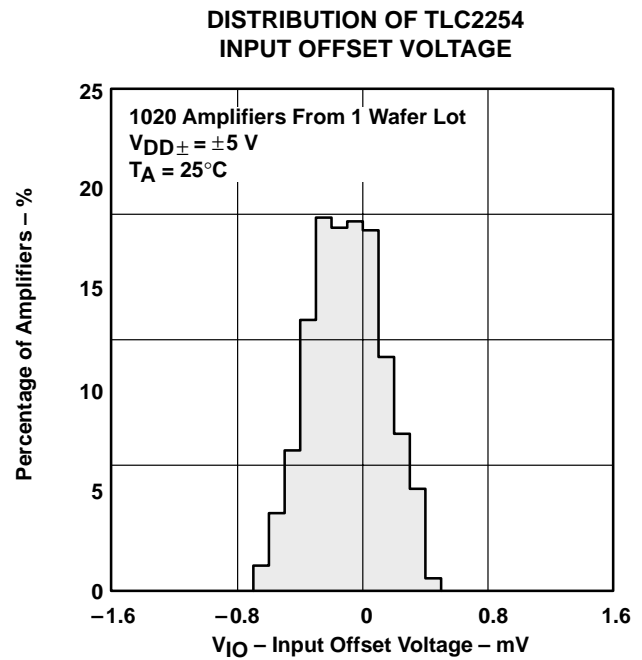

**Figure 5**

TYPICAL CHARACTERISTICS

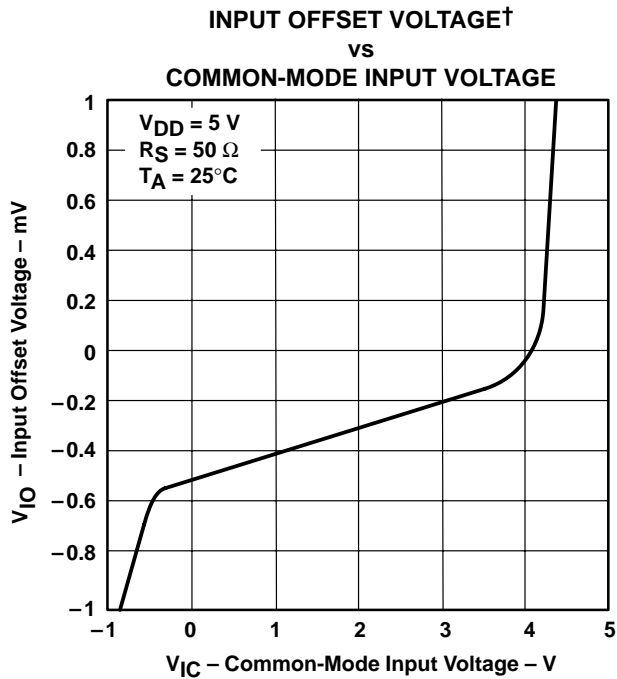

Figure 6

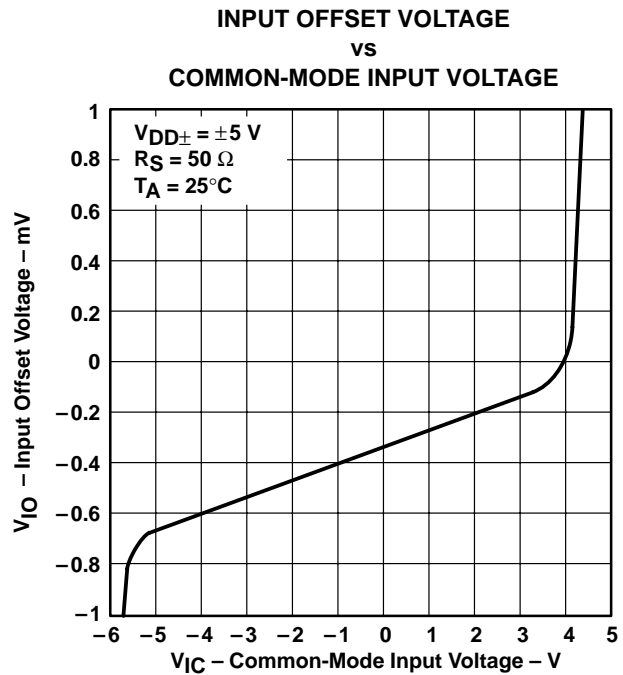

Figure 7

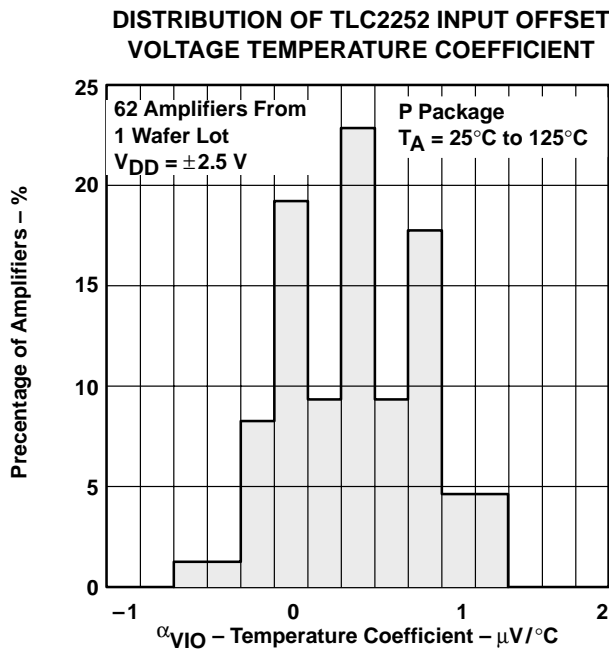

Figure 8

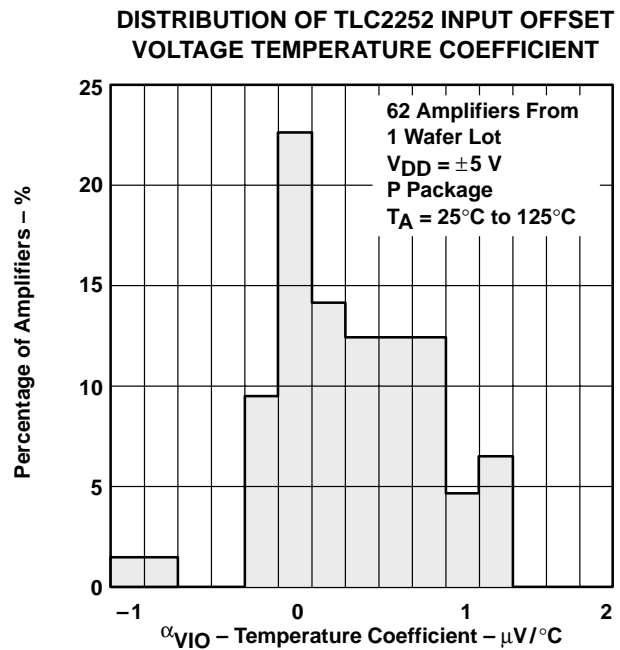

Figure 9

† For curves where  $V_{DD} = 5\text{ V}$ , all loads are referenced to 2.5 V.



TYPICAL CHARACTERISTICS

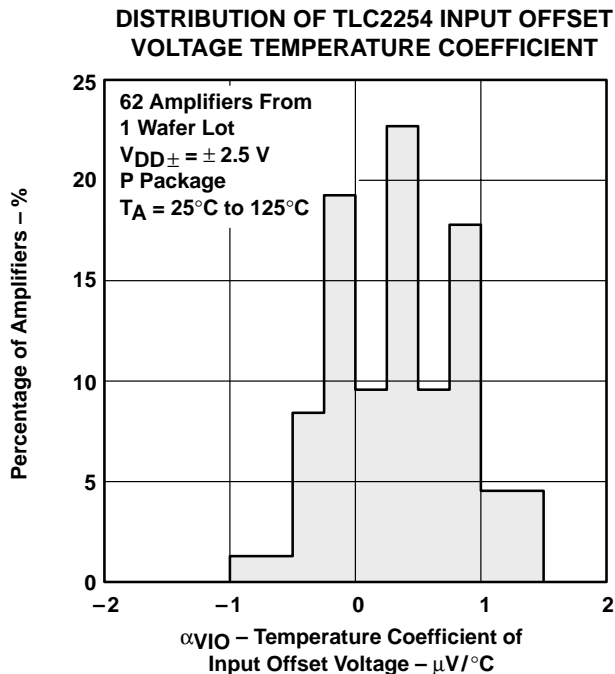

Figure 10



Figure 11

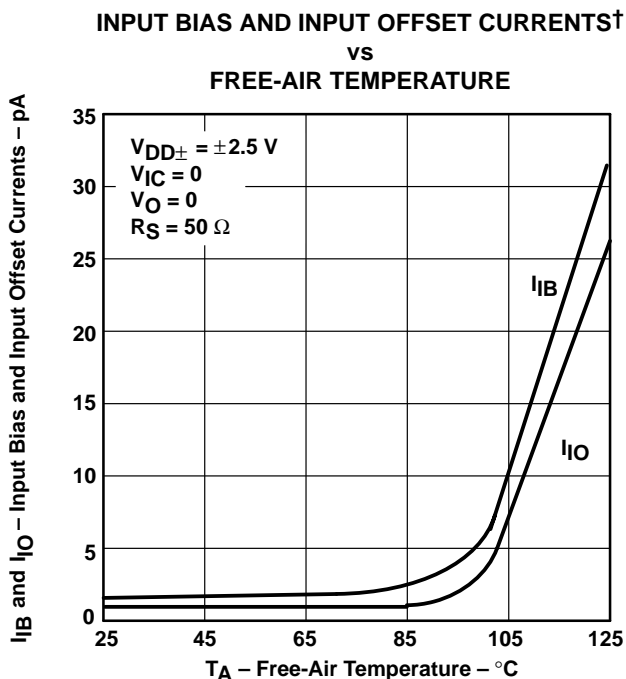

Figure 12

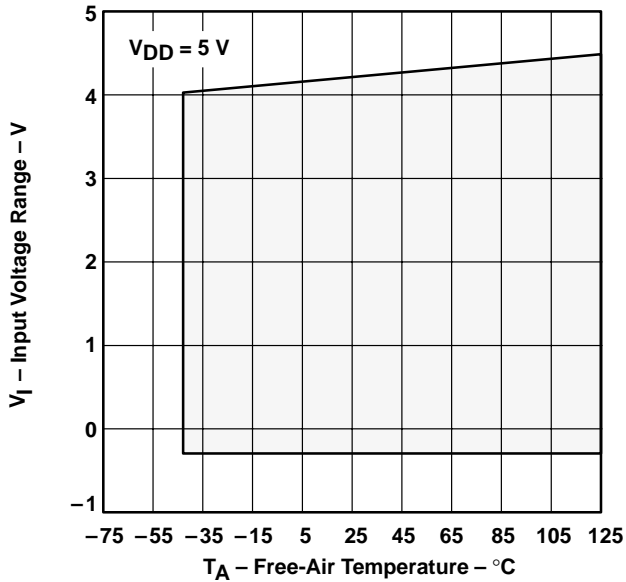

Figure 13

† Data at high and low temperatures are applicable only within the rated operating free-air temperature ranges of the various devices.

**TYPICAL CHARACTERISTICS**

**INPUT VOLTAGE RANGE†**  
**vs**  
**FREE-AIR TEMPERATURE**



**Figure 14**

**HIGH-LEVEL OUTPUT VOLTAGE†‡**  
**vs**  
**HIGH-LEVEL OUTPUT CURRENT**

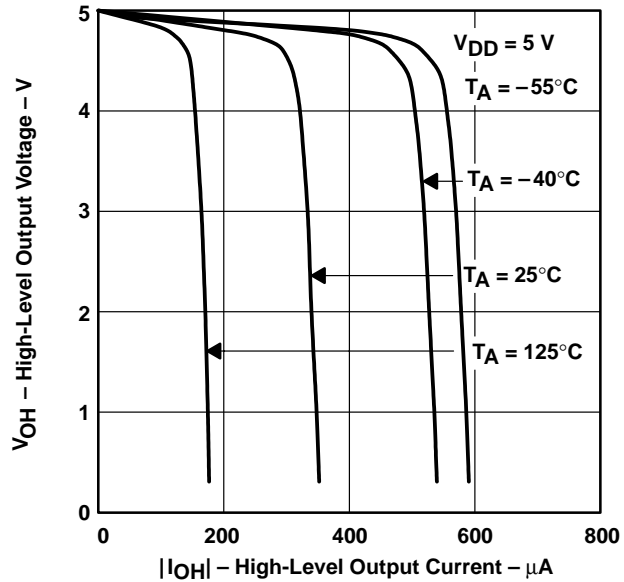

**Figure 15**

**LOW-LEVEL OUTPUT VOLTAGE†**  
**vs**  
**LOW-LEVEL OUTPUT CURRENT**

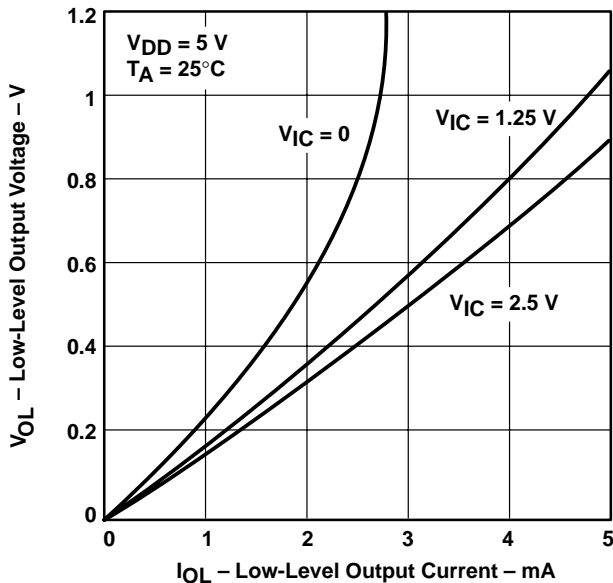

**Figure 16**

**LOW-LEVEL OUTPUT VOLTAGE†‡**  
**vs**  
**LOW-LEVEL OUTPUT CURRENT**

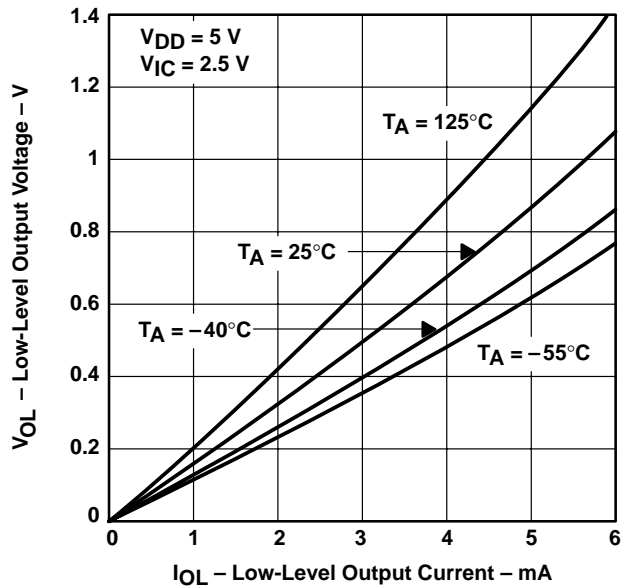

**Figure 17**

† Data at high and low temperatures are applicable only within the rated operating free-air temperature ranges of the various devices.  
 ‡ For curves where  $V_{DD} = 5\text{ V}$ , all loads are referenced to 2.5 V.

TYPICAL CHARACTERISTICS

MAXIMUM POSITIVE PEAK OUTPUT VOLTAGE†  
 vs  
 OUTPUT CURRENT

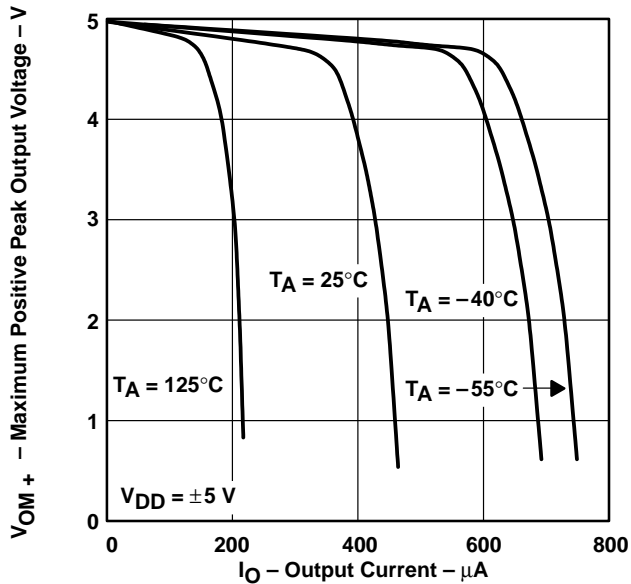

Figure 18

MAXIMUM NEGATIVE PEAK OUTPUT VOLTAGE†  
 vs  
 OUTPUT CURRENT

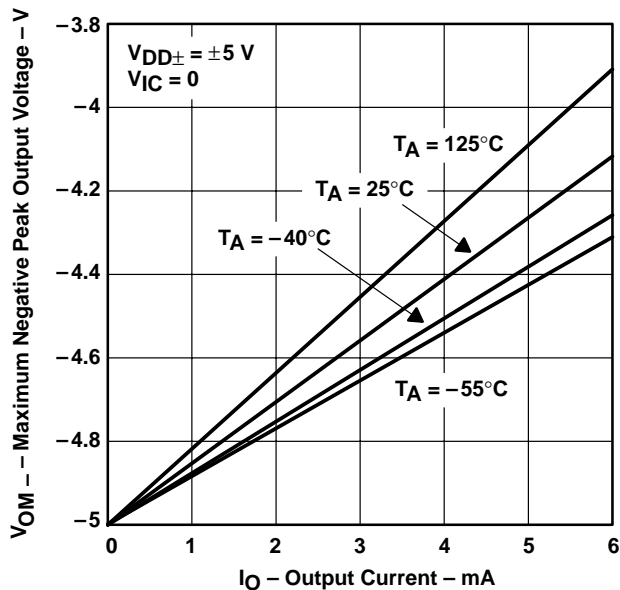

Figure 19

MAXIMUM PEAK-TO-PEAK OUTPUT VOLTAGE‡  
 vs  
 FREQUENCY

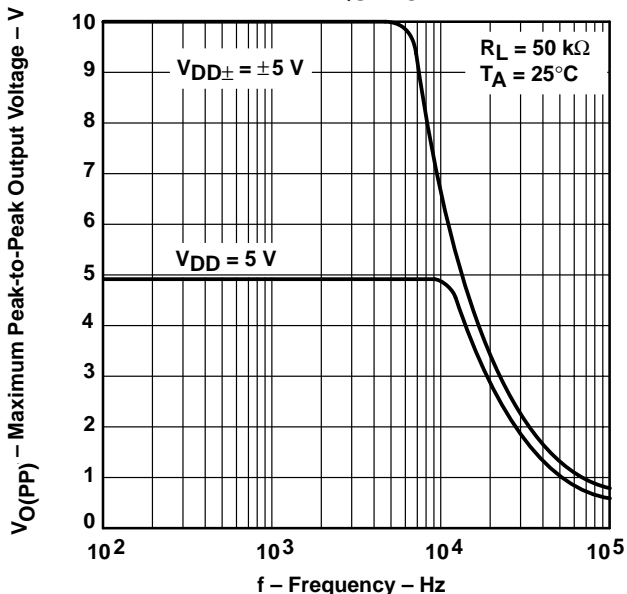

Figure 20

SHORT-CIRCUIT OUTPUT CURRENT  
 vs  
 SUPPLY VOLTAGE

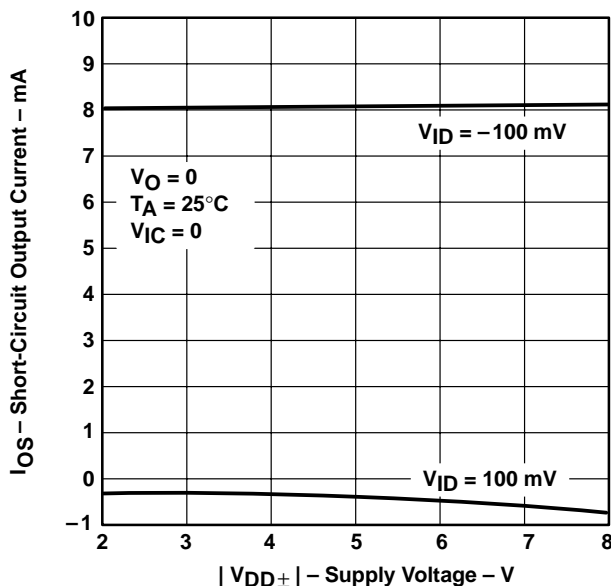

Figure 21

† Data at high and low temperatures are applicable only within the rated operating free-air temperature ranges of the various devices.  
 ‡ For curves where  $V_{DD} = 5\text{ V}$ , all loads are referenced to  $2.5\text{ V}$ .

TYPICAL CHARACTERISTICS



Figure 22

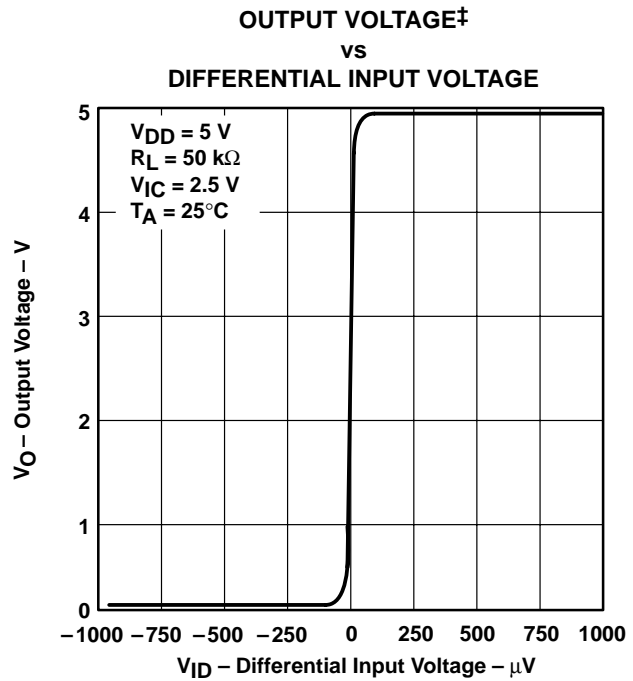

Figure 23

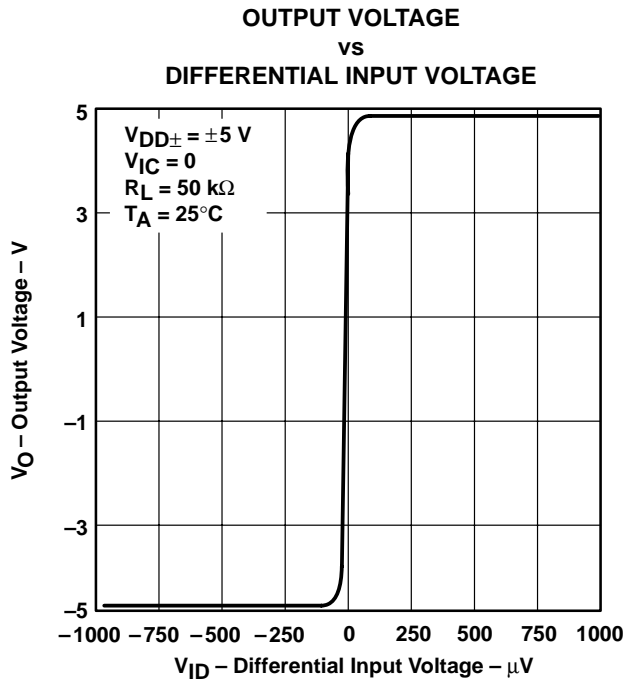

Figure 24

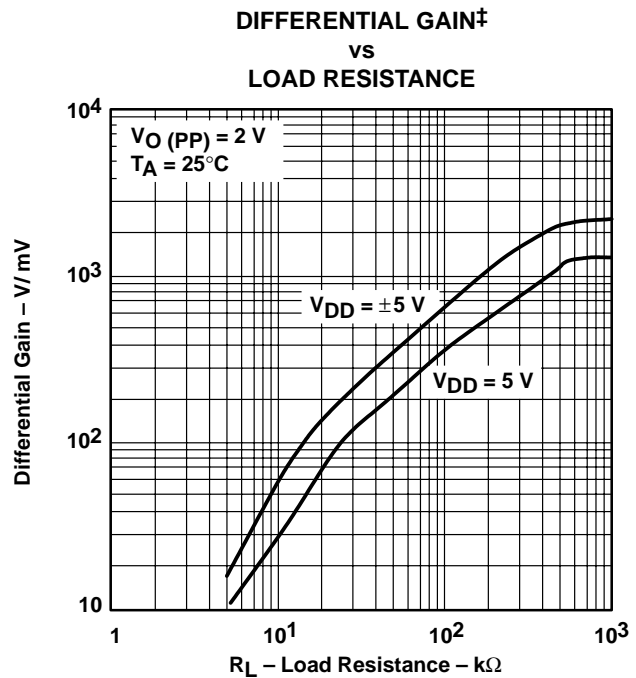

Figure 25

† Data at high and low temperatures are applicable only within the rated operating free-air temperature ranges of the various devices.

‡ For curves where  $V_{DD} = 5$  V, all loads are referenced to 2.5 V.

TYPICAL CHARACTERISTICS

LARGE-SIGNAL DIFFERENTIAL VOLTAGE  
 AMPLIFICATION AND PHASE MARGIN†  
 VS  
 FREQUENCY



Figure 26

LARGE-SIGNAL DIFFERENTIAL VOLTAGE  
 AMPLIFICATION AND PHASE MARGIN  
 VS  
 FREQUENCY

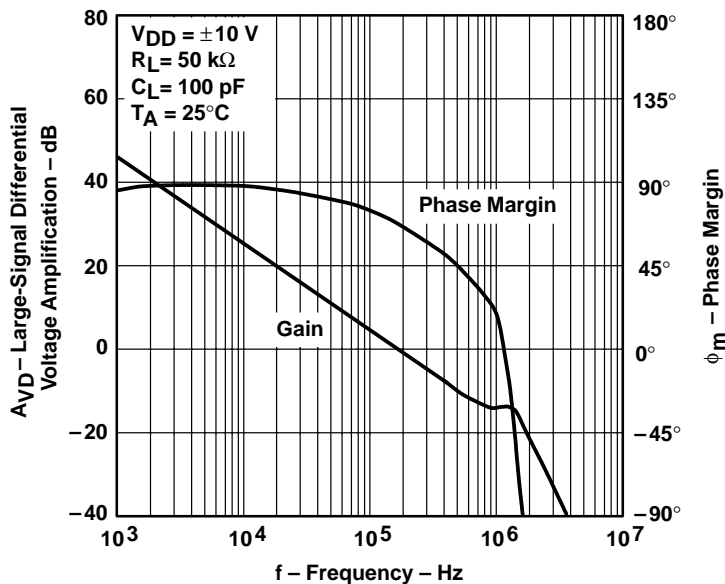

Figure 27

† For curves where V<sub>DD</sub> = 5 V, all loads are referenced to 2.5 V.

**TLC225x, TLC225xA**  
**Advanced LinCMOS™ RAIL-TO-RAIL**  
**VERY LOW-POWER OPERATIONAL AMPLIFIERS**

SLOS176D – FEBRUARY 1997 – REVISED MARCH 2001

**TYPICAL CHARACTERISTICS**

**LARGE-SIGNAL DIFFERENTIAL VOLTAGE AMPLIFICATION†‡**  
**vs**  
**FREE-AIR TEMPERATURE**

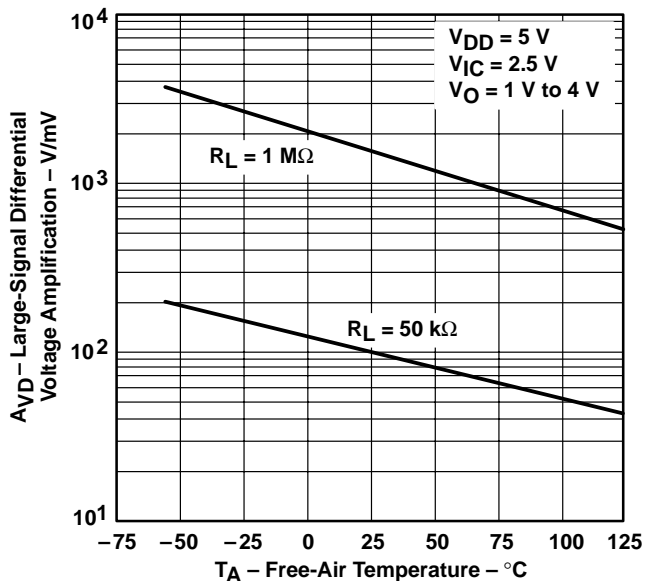

**Figure 28**

**LARGE-SIGNAL DIFFERENTIAL VOLTAGE AMPLIFICATION†**  
**vs**  
**FREE-AIR TEMPERATURE**

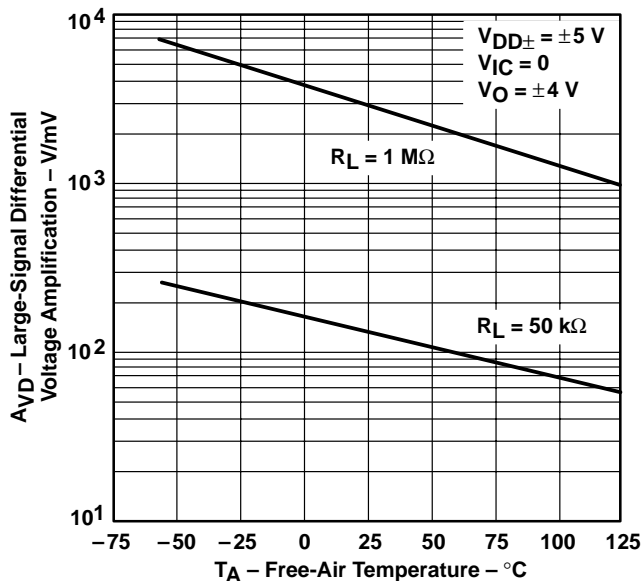

**Figure 29**

**OUTPUT IMPEDANCE‡**  
**vs**  
**FREQUENCY**

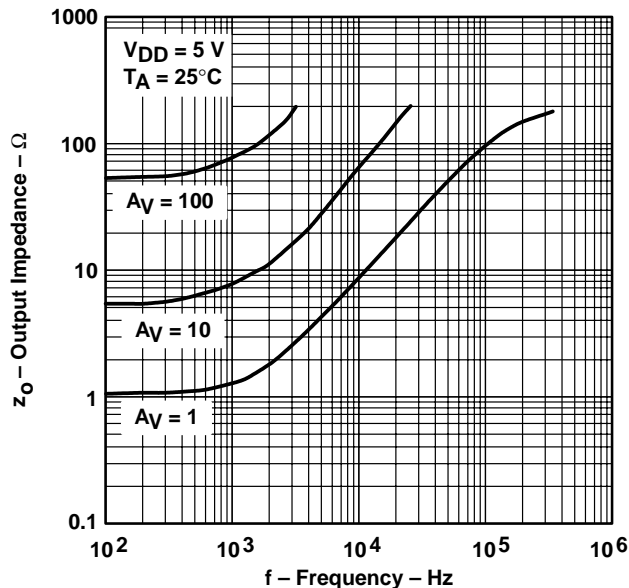

**Figure 30**

**OUTPUT IMPEDANCE**  
**vs**  
**FREQUENCY**

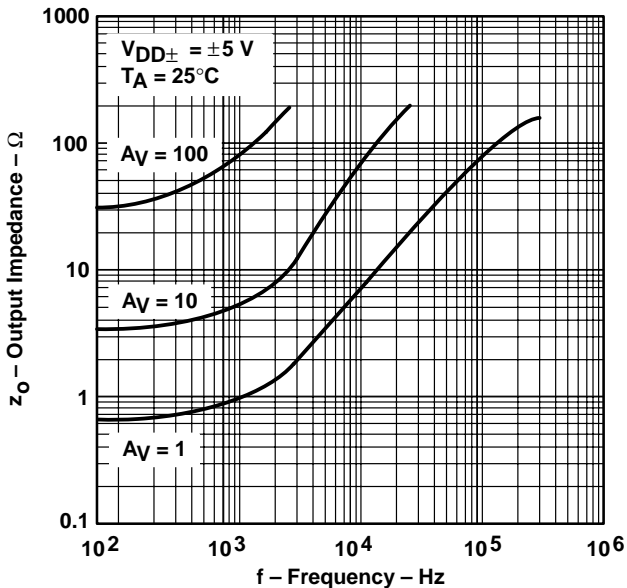

**Figure 31**

† Data at high and low temperatures are applicable only within the rated operating free-air temperature ranges of the various devices.

‡ For curves where V<sub>DD</sub> = 5 V, all loads are referenced to 2.5 V.



TYPICAL CHARACTERISTICS



Figure 32

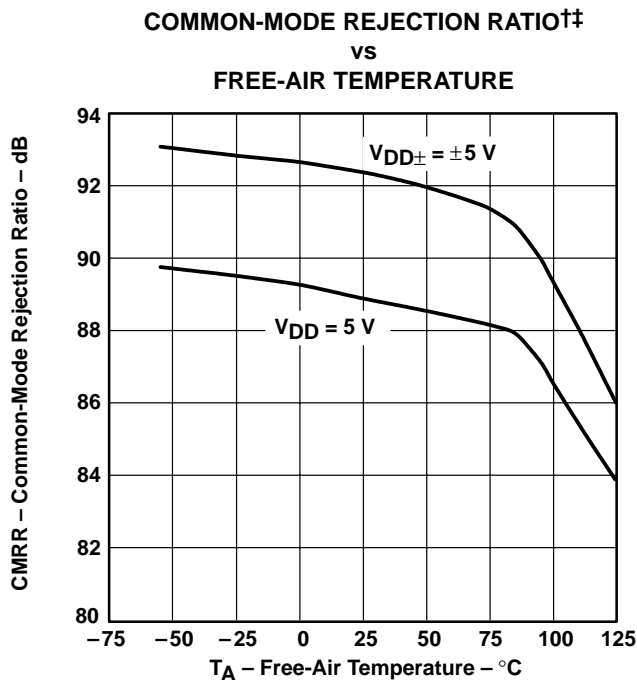

Figure 33



Figure 34

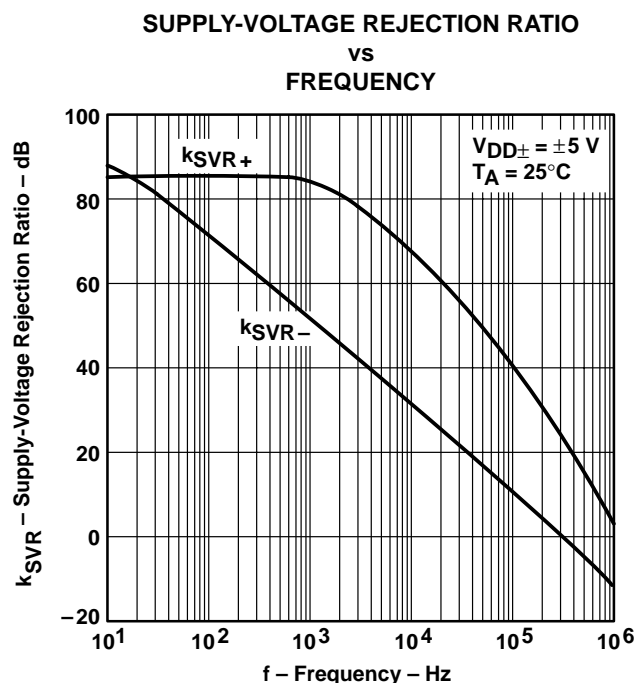
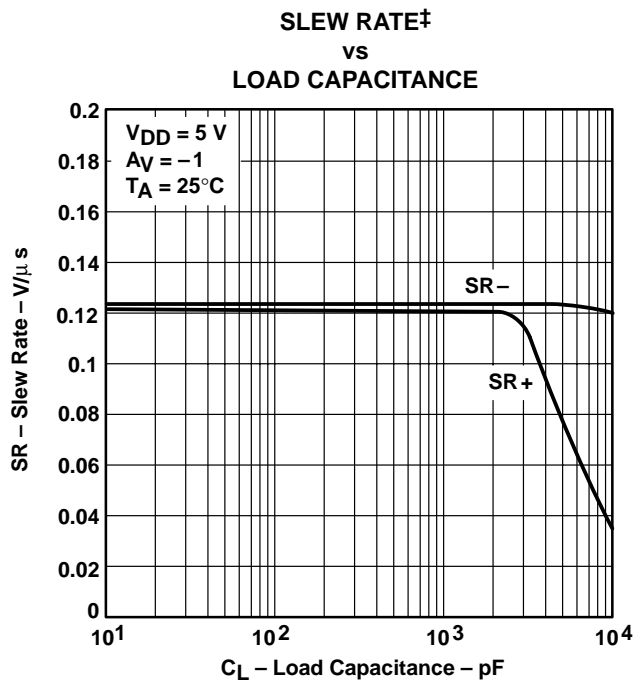
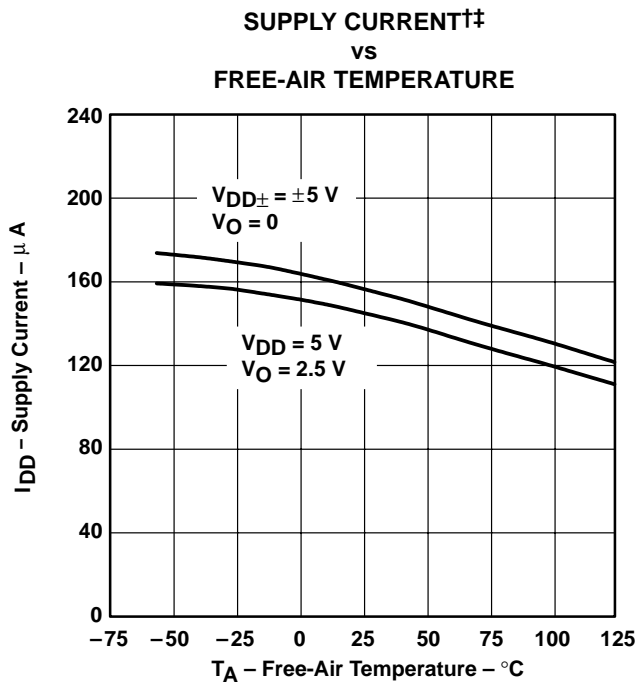
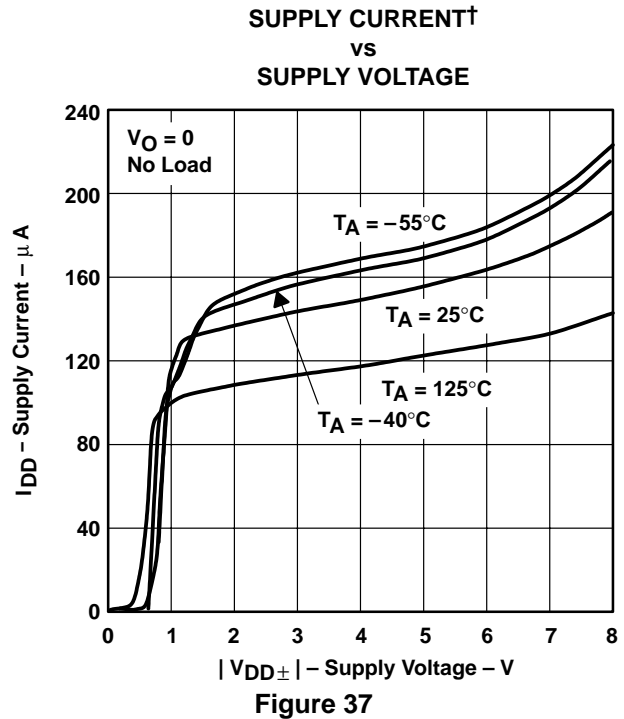
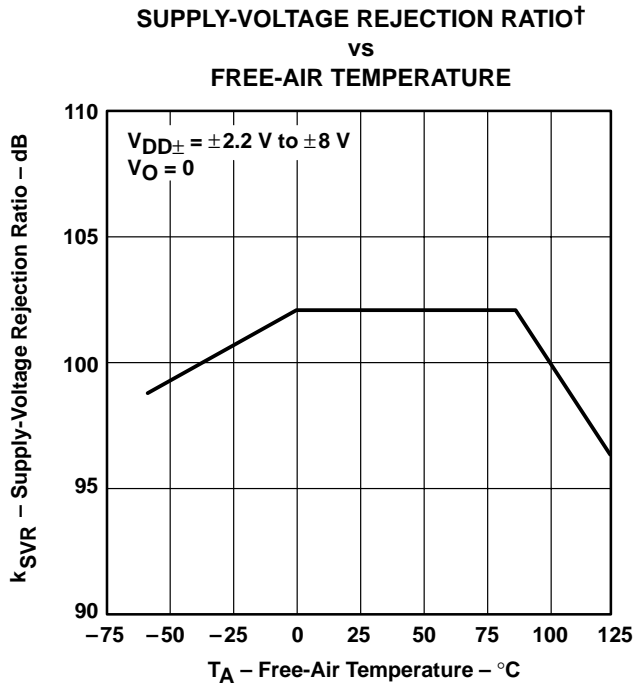

Figure 35

† For curves where  $V_{DD} = 5\text{ V}$ , all loads are referenced to 2.5 V.

†† Data at high and low temperatures are applicable only within the rated operating free-air temperature ranges of the various devices.

TYPICAL CHARACTERISTICS



† Data at high and low temperatures are applicable only within the rated operating free-air temperature ranges of the various devices.

‡ For curves where  $V_{DD} = 5\text{ V}$ , all loads are referenced to 2.5 V.



TYPICAL CHARACTERISTICS

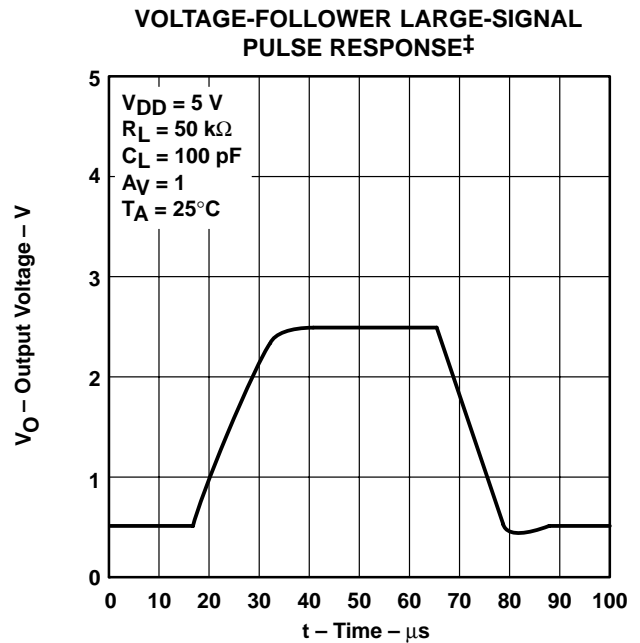
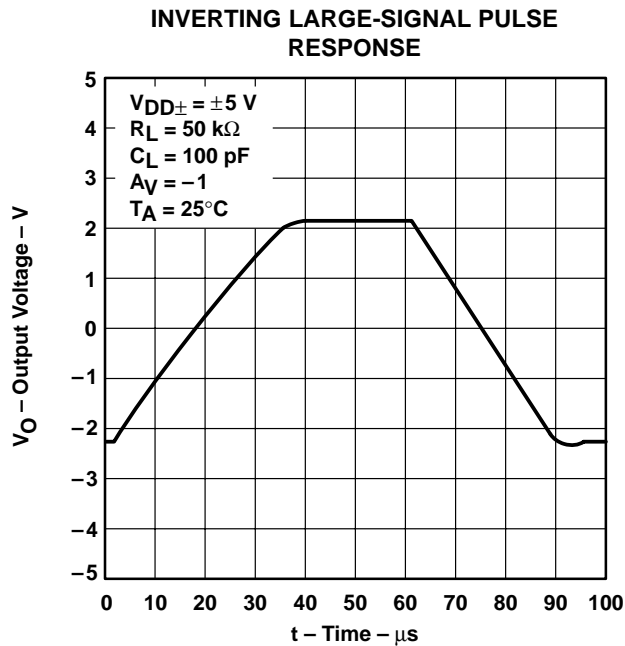
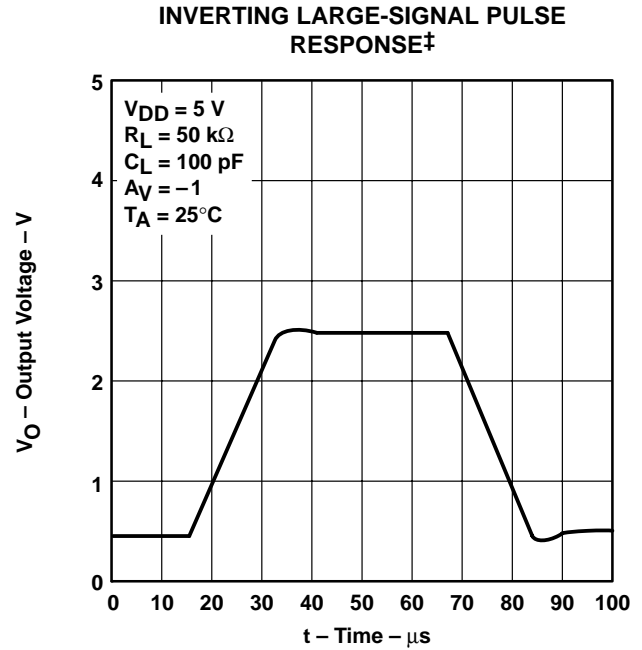
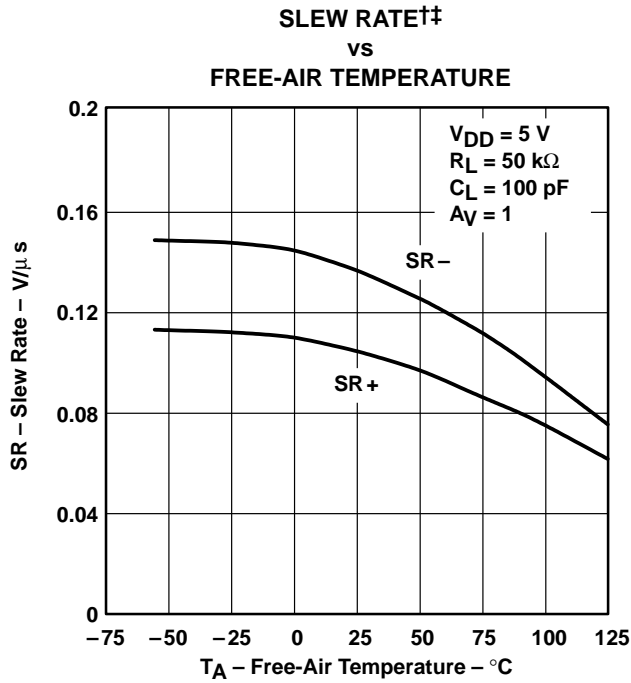

† Data at high and low temperatures are applicable only within the rated operating free-air temperature ranges of the various devices.

‡ For curves where  $V_{DD} = 5\text{ V}$ , all loads are referenced to 2.5 V.

TYPICAL CHARACTERISTICS

VOLTAGE-FOLLOWER LARGE-SIGNAL PULSE RESPONSE

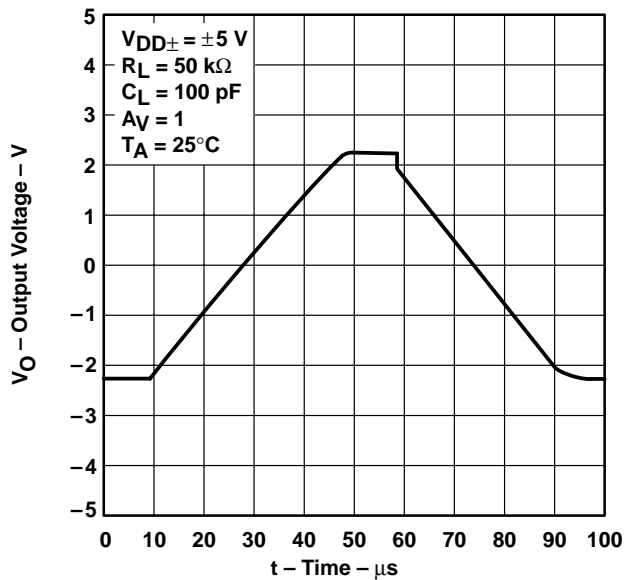

Figure 44

INVERTING SMALL-SIGNAL PULSE RESPONSE†

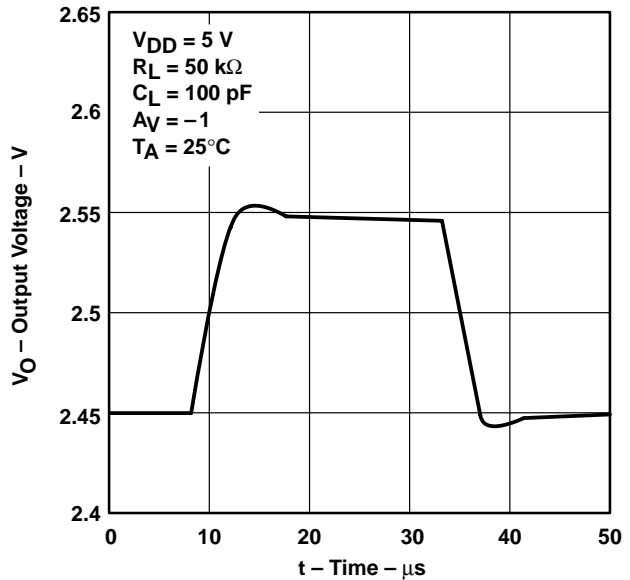

Figure 45

INVERTING SMALL-SIGNAL PULSE RESPONSE



Figure 46

VOLTAGE-FOLLOWER SMALL-SIGNAL PULSE RESPONSE†

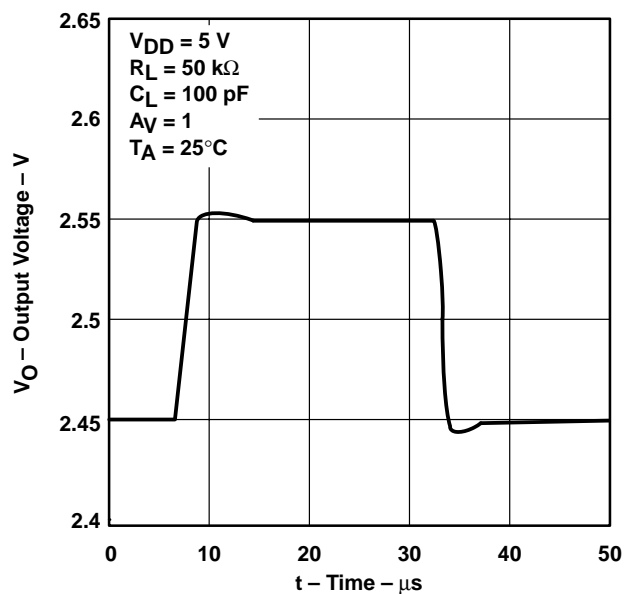

Figure 47

† For curves where  $V_{DD} = 5\text{ V}$ , all loads are referenced to 2.5 V.

TYPICAL CHARACTERISTICS



Figure 48

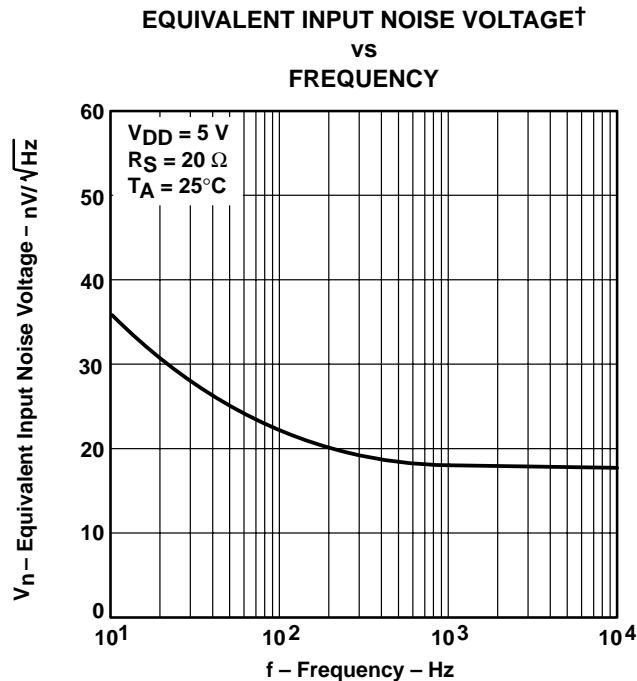

Figure 49



Figure 50

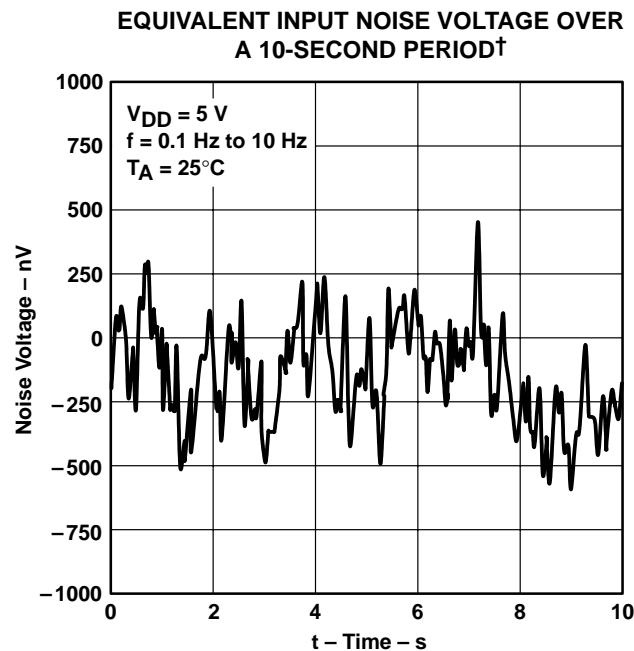
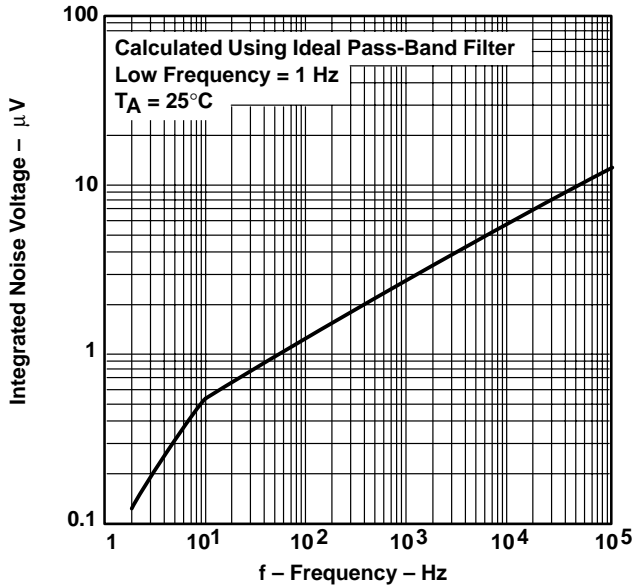

Figure 51

† For curves where  $V_{DD} = 5 \text{ V}$ , all loads are referenced to 2.5 V.

**TYPICAL CHARACTERISTICS**

**INTEGRATED NOISE VOLTAGE  
 VS  
 FREQUENCY**



**Figure 52**

**TOTAL HARMONIC DISTORTION PLUS NOISE†  
 VS  
 FREQUENCY**

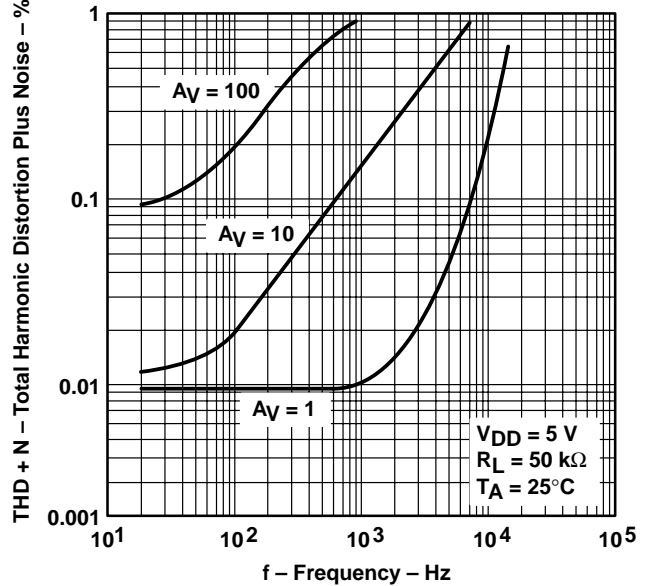

**Figure 53**

**GAIN-BANDWIDTH PRODUCT‡  
 VS  
 FREE-AIR TEMPERATURE**

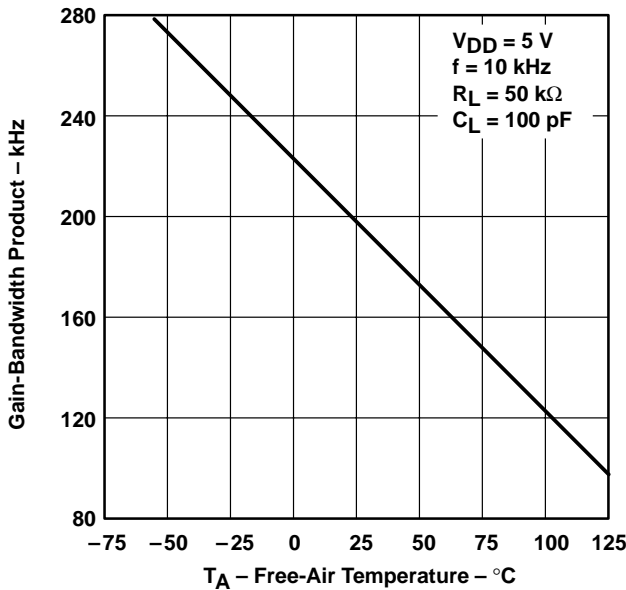

**Figure 54**

**GAIN-BANDWIDTH PRODUCT  
 VS  
 SUPPLY VOLTAGE**

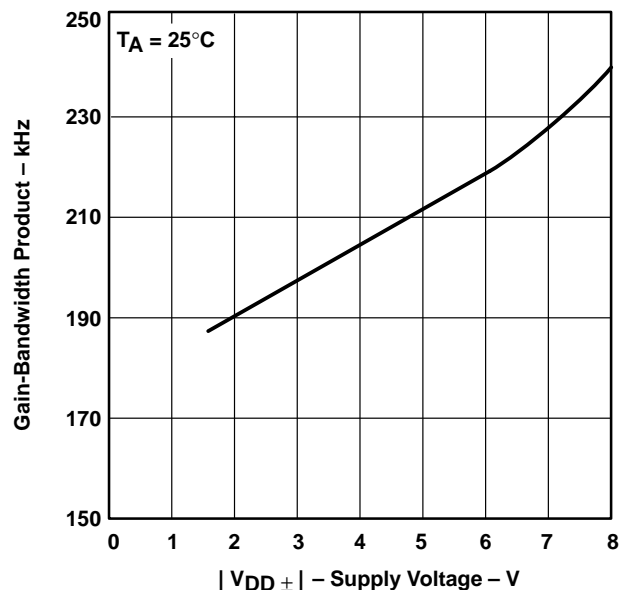

**Figure 55**

† For curves where  $V_{DD} = 5\text{ V}$ , all loads are referenced to  $2.5\text{ V}$ .

‡ Data at high and low temperatures are applicable only within the rated operating free-air temperature ranges of the various devices.

TYPICAL CHARACTERISTICS



Figure 56

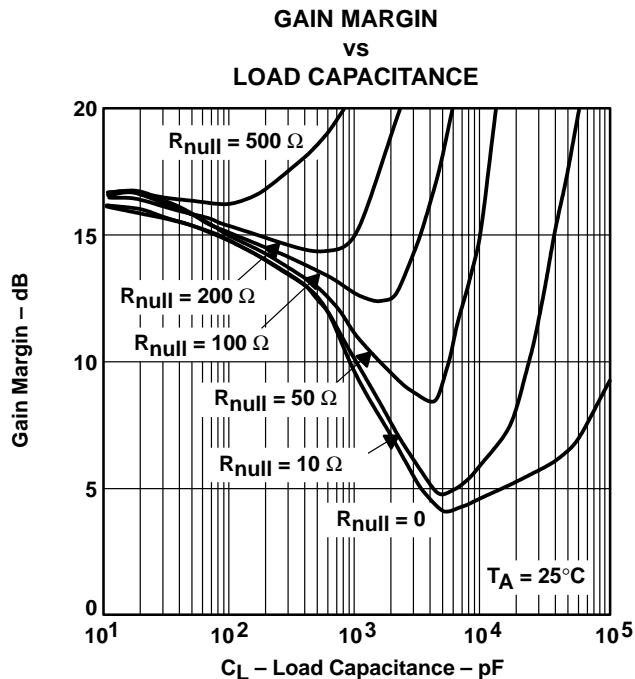

Figure 57

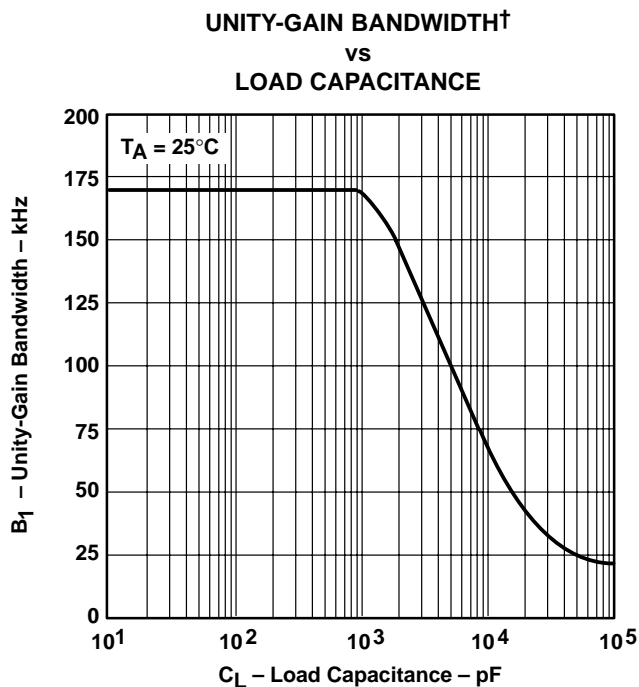

Figure 58

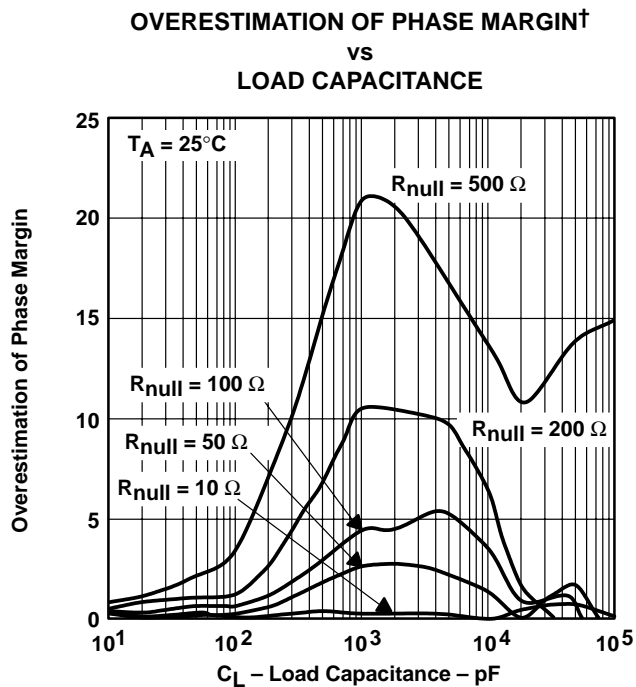

Figure 59

† See application information

**APPLICATION INFORMATION**

**driving large capacitive loads**

The TLC225x is designed to drive larger capacitive loads than most CMOS operational amplifiers. Figure 56 and Figure 57 illustrate its ability to drive loads up to 1000 pF while maintaining good gain and phase margins ( $R_{null} = 0$ ).

A smaller series resistor ( $R_{null}$ ) at the output of the device (see Figure 60) improves the gain and phase margins when driving large capacitive loads. Figure 56 and Figure 57 show the effects of adding series resistances of 10  $\Omega$ , 50  $\Omega$ , 100  $\Omega$ , 200  $\Omega$ , and 500  $\Omega$ . The addition of this series resistor has two effects: the first is that it adds a zero to the transfer function and the second is that it reduces the frequency of the pole associated with the output load in the transfer function.

The zero introduced to the transfer function is equal to the series resistance times the load capacitance. To calculate the improvement in phase margin, equation 1 can be used.

$$\Delta\phi_{m1} = \tan^{-1} \left( 2 \times \pi \times \text{UGBW} \times R_{null} \times C_L \right) \tag{1}$$

Where :

- $\Delta\phi_{m1}$  = Improvement in phase margin
- UGBW = Unity-gain bandwidth frequency
- $R_{null}$  = Output series resistance
- $C_L$  = Load capacitance

The unity-gain bandwidth (UGBW) frequency decreases as the capacitive load increases (see Figure 58). To use equation 1, UGBW must be approximated from Figure 58.

Using equation 1 alone overestimates the improvement in phase margin, as illustrated in Figure 59. The overestimation is caused by the decrease in the frequency of the pole associated with the load, thus providing additional phase shift and reducing the overall improvement in phase margin.

Using Figure 60, with equation 1 enables the designer to choose the appropriate output series resistance to optimize the design of circuits driving large capacitance loads.

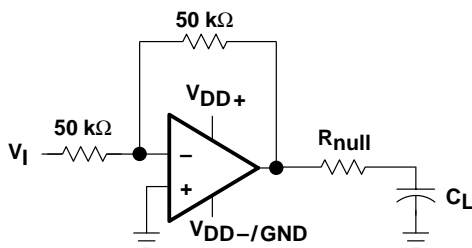

**Figure 60. Series-Resistance Circuit**

## APPLICATION INFORMATION

### macromodel information

Macromodel information provided was derived using MicroSim *Parts*™, the model generation software used with MicroSim *PSpice*™. The Boyle macromodel (see Note 5) and subcircuit in Figure 61 are generated using the TLC225x typical electrical and operating characteristics at  $T_A = 25^\circ\text{C}$ . Using this information, output simulations of the following key parameters can be generated to a tolerance of 20% (in most cases):

- Maximum positive output voltage swing
- Maximum negative output voltage swing
- Slew rate
- Quiescent power dissipation
- Input bias current
- Open-loop voltage amplification
- Unity-gain frequency
- Common-mode rejection ratio
- Phase margin
- DC output resistance
- AC output resistance
- Short-circuit output current limit

NOTE 5: G. R. Boyle, B. M. Cohn, D. O. Pederson, and J. E. Solomon, "Macromodeling of Integrated Circuit Operational Amplifiers", *IEEE Journal of Solid-State Circuits*, SC-9, 353 (1974).

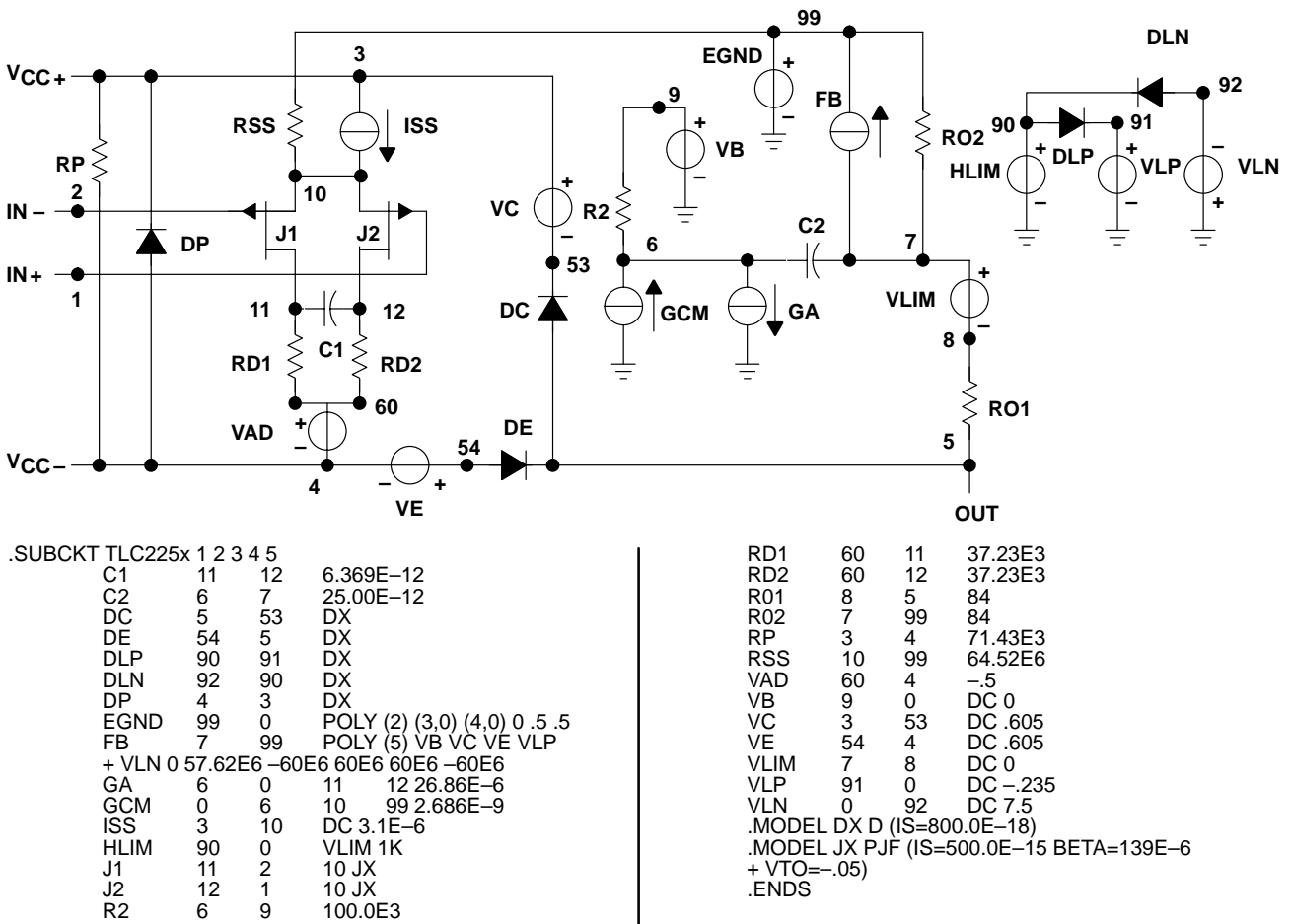

**Figure 61. Boyle Macromodel and Subcircuit**

*PSpice* and *Parts* are trademarks of MicroSim Corporation.

**PACKAGING INFORMATION**

| Orderable part number              | Status<br>(1) | Material type<br>(2) | Package   Pins | Package qty   Carrier | RoHS<br>(3) | Lead finish/<br>Ball material<br>(4) | MSL rating/<br>Peak reflow<br>(5) | Op temp (°C) | Part marking<br>(6)                     |
|------------------------------------|---------------|----------------------|----------------|-----------------------|-------------|--------------------------------------|-----------------------------------|--------------|---|
| <a href="#">5962-9564001Q2A</a>    | Active        | Production           | LCCC (FK)   20 | 55   TUBE             | No          | SNPB                                 | N/A for Pkg Type                  | -55 to 125   | 5962-<br>9564001Q2A<br>TLC2252<br>MFKB  |
| <a href="#">5962-9564001QHA</a>    | Active        | Production           | CFP (U)   10   | 25   TUBE             | No          | SNPB                                 | N/A for Pkg Type                  | -55 to 125   | 9564001QHA<br>TLC2252M                  |
| <a href="#">5962-9564001QPA</a>    | Active        | Production           | CDIP (JG)   8  | 50   TUBE             | No          | SNPB                                 | N/A for Pkg Type                  | -55 to 125   | 9564001QPA<br>TLC2252M                  |
| <a href="#">5962-9564002Q2A</a>    | Active        | Production           | LCCC (FK)   20 | 55   TUBE             | No          | SNPB                                 | N/A for Pkg Type                  | -55 to 125   | 5962-<br>9564002Q2A<br>TLC2254<br>MFKB  |
| <a href="#">5962-9564002QDA</a>    | Active        | Production           | CFP (W)   14   | 25   TUBE             | No          | SNPB                                 | N/A for Pkg Type                  | -55 to 125   | 5962-9564002QD<br>A<br>TLC2254MWB       |
| <a href="#">5962-9564003NXD</a>    | Active        | Production           | SOIC (D)   8   | 2500   LARGE T&R      | Yes         | NIPDAU                               | Level-1-260C-UNLIM                | -55 to 125   | Q2252A                                  |
| <a href="#">5962-9564003NXDR</a>   | Active        | Production           | SOIC (D)   8   | 2500   LARGE T&R      | Yes         | NIPDAU                               | Level-1-260C-UNLIM                | -55 to 125   | Q2252A                                  |
| <a href="#">5962-9564003NXDR.A</a> | Active        | Production           | SOIC (D)   8   | 2500   LARGE T&R      | Yes         | NIPDAU                               | Level-1-260C-UNLIM                | -55 to 125   | Q2252A                                  |
| <a href="#">5962-9564003Q2A</a>    | Active        | Production           | LCCC (FK)   20 | 55   TUBE             | No          | SNPB                                 | N/A for Pkg Type                  | -55 to 125   | 5962-<br>9564003Q2A<br>TLC2252<br>AMFKB |
| <a href="#">5962-9564003QHA</a>    | Active        | Production           | CFP (U)   10   | 25   TUBE             | No          | SNPB                                 | N/A for Pkg Type                  | -55 to 125   | 9564003QHA<br>TLC2252AM                 |
| <a href="#">5962-9564003QPA</a>    | Active        | Production           | CDIP (JG)   8  | 50   TUBE             | No          | SNPB                                 | N/A for Pkg Type                  | -55 to 125   | 9564003QPA<br>TLC2252AM                 |
| <a href="#">5962-9564004Q2A</a>    | Active        | Production           | LCCC (FK)   20 | 55   TUBE             | No          | SNPB                                 | N/A for Pkg Type                  | -55 to 125   | 5962-<br>9564004Q2A<br>TLC2254<br>AMFKB |
| <a href="#">5962-9564004QDA</a>    | Active        | Production           | CFP (W)   14   | 25   TUBE             | No          | SNPB                                 | N/A for Pkg Type                  | -55 to 125   | 5962-9564004QD<br>A<br>TLC2254AMWB      |
| <a href="#">TLC2252AID</a>         | Active        | Production           | SOIC (D)   8   | 75   TUBE             | Yes         | NIPDAU                               | Level-1-260C-UNLIM                | -            | 2252AI                                  |



| Orderable part number        | Status<br>(1) | Material type<br>(2) | Package   Pins | Package qty   Carrier | RoHS<br>(3) | Lead finish/<br>Ball material<br>(4) | MSL rating/<br>Peak reflow<br>(5) | Op temp (°C)    | Part marking<br>(6)                 |
|------------------------------|---------------|----------------------|----------------|-----------------------|-------------|--------------------------------------|-----------------------------------|-----------------|-------------------------------------|
| TLC2252AID.B                 | Active        | Production           | SOIC (D)   8   | 75   TUBE             | Yes         | NIPDAU                               | Level-1-260C-UNLIM                | -40 to 125      | 2252AI                              |
| TLC2252AIDG4                 | Active        | Production           | SOIC (D)   8   | 75   TUBE             | -           | Call TI                              | Call TI                           | See TLC2252AID  |                                     |
| <a href="#">TLC2252AIDR</a>  | Active        | Production           | SOIC (D)   8   | 2500   LARGE T&R      | Yes         | NIPDAU                               | Level-1-260C-UNLIM                | -               | 2252AI                              |
| TLC2252AIDR.B                | Active        | Production           | SOIC (D)   8   | 2500   LARGE T&R      | Yes         | NIPDAU                               | Level-1-260C-UNLIM                | -40 to 125      | 2252AI                              |
| TLC2252AIDRG4                | Active        | Production           | SOIC (D)   8   | 2500   LARGE T&R      | -           | Call TI                              | Call TI                           | See TLC2252AIDR |                                     |
| <a href="#">TLC2252AIP</a>   | Active        | Production           | PDIP (P)   8   | 50   TUBE             | Yes         | NIPDAU                               | N/A for Pkg Type                  | -               | TLC2252AI                           |
| TLC2252AIP.A                 | Active        | Production           | PDIP (P)   8   | 50   TUBE             | Yes         | NIPDAU                               | N/A for Pkg Type                  | -40 to 125      | TLC2252AI                           |
| <a href="#">TLC2252AIPWR</a> | Active        | Production           | TSSOP (PW)   8 | 2000   LARGE T&R      | Yes         | NIPDAU                               | Level-1-260C-UNLIM                | -               | Y2252A                              |
| TLC2252AIPWR.B               | Active        | Production           | TSSOP (PW)   8 | 2000   LARGE T&R      | Yes         | NIPDAU                               | Level-1-260C-UNLIM                | -40 to 125      | Y2252A                              |
| <a href="#">TLC2252AMFKB</a> | Active        | Production           | LCCC (FK)   20 | 55   TUBE             | No          | SNPB                                 | N/A for Pkg Type                  | -55 to 125      | 5962-9564003Q2A<br>TLC2252<br>AMFKB |
| TLC2252AMFKB.A               | Active        | Production           | LCCC (FK)   20 | 55   TUBE             | No          | SNPB                                 | N/A for Pkg Type                  | -55 to 125      | 5962-9564003Q2A<br>TLC2252<br>AMFKB |
| <a href="#">TLC2252AMJGB</a> | Active        | Production           | CDIP (JG)   8  | 50   TUBE             | No          | SNPB                                 | N/A for Pkg Type                  | -55 to 125      | 9564003QPA<br>TLC2252AM             |
| TLC2252AMJGB.A               | Active        | Production           | CDIP (JG)   8  | 50   TUBE             | No          | SNPB                                 | N/A for Pkg Type                  | -55 to 125      | 9564003QPA<br>TLC2252AM             |
| <a href="#">TLC2252AMUB</a>  | Active        | Production           | CFP (U)   10   | 25   TUBE             | No          | SNPB                                 | N/A for Pkg Type                  | -55 to 125      | 9564003QHA<br>TLC2252AM             |
| TLC2252AMUB.A                | Active        | Production           | CFP (U)   10   | 25   TUBE             | No          | SNPB                                 | N/A for Pkg Type                  | -55 to 125      | 9564003QHA<br>TLC2252AM             |
| <a href="#">TLC2252AQDR</a>  | Active        | Production           | SOIC (D)   8   | 2500   LARGE T&R      | Yes         | NIPDAU                               | Level-1-260C-UNLIM                | -40 to 125      | C2252A                              |
| TLC2252AQDR.A                | Active        | Production           | SOIC (D)   8   | 2500   LARGE T&R      | Yes         | NIPDAU                               | Level-1-260C-UNLIM                | -40 to 125      | C2252A                              |
| <a href="#">TLC2252CD</a>    | Active        | Production           | SOIC (D)   8   | 75   TUBE             | Yes         | NIPDAU                               | Level-1-260C-UNLIM                | 0 to 70         | 2252C                               |
| TLC2252CD.B                  | Active        | Production           | SOIC (D)   8   | 75   TUBE             | Yes         | NIPDAU                               | Level-1-260C-UNLIM                | 0 to 70         | 2252C                               |
| TLC2252CDG4                  | Active        | Production           | SOIC (D)   8   | 75   TUBE             | -           | Call TI                              | Call TI                           | 0 to 70         |                                     |
| <a href="#">TLC2252CDR</a>   | Active        | Production           | SOIC (D)   8   | 2500   LARGE T&R      | Yes         | NIPDAU                               | Level-1-260C-UNLIM                | 0 to 70         | 2252C                               |
| TLC2252CDR.B                 | Active        | Production           | SOIC (D)   8   | 2500   LARGE T&R      | Yes         | NIPDAU                               | Level-1-260C-UNLIM                | 0 to 70         | 2252C                               |
| <a href="#">TLC2252CP</a>    | Active        | Production           | PDIP (P)   8   | 50   TUBE             | Yes         | NIPDAU                               | N/A for Pkg Type                  | 0 to 70         | TLC2252CP                           |

| Orderable part number        | Status<br>(1) | Material type<br>(2) | Package   Pins  | Package qty   Carrier | RoHS<br>(3) | Lead finish/<br>Ball material<br>(4) | MSL rating/<br>Peak reflow<br>(5) | Op temp (°C)    | Part marking<br>(6)                    |
|------------------------------|---------------|----------------------|-----------------|-----------------------|-------------|--------------------------------------|-----------------------------------|-----------------|--|
| TLC2252CP.B                  | Active        | Production           | PDIP (P)   8    | 50   TUBE             | Yes         | NIPDAU                               | N/A for Pkg Type                  | 0 to 70         | TLC2252CP                              |
| <a href="#">TLC2252CPWR</a>  | Active        | Production           | TSSOP (PW)   8  | 2000   LARGE T&R      | Yes         | NIPDAU                               | Level-1-260C-UNLIM                | 0 to 70         | P2252                                  |
| TLC2252CPWR.B                | Active        | Production           | TSSOP (PW)   8  | 2000   LARGE T&R      | Yes         | NIPDAU                               | Level-1-260C-UNLIM                | 0 to 70         | P2252                                  |
| <a href="#">TLC2252IDR</a>   | Active        | Production           | SOIC (D)   8    | 2500   LARGE T&R      | Yes         | NIPDAU                               | Level-1-260C-UNLIM                | -40 to 125      | 2252I                                  |
| TLC2252IDR.B                 | Active        | Production           | SOIC (D)   8    | 2500   LARGE T&R      | Yes         | NIPDAU                               | Level-1-260C-UNLIM                | -40 to 125      | 2252I                                  |
| <a href="#">TLC2252IP</a>    | Active        | Production           | PDIP (P)   8    | 50   TUBE             | Yes         | NIPDAU                               | N/A for Pkg Type                  | -40 to 125      | TLC2252IP                              |
| TLC2252IP.A                  | Active        | Production           | PDIP (P)   8    | 50   TUBE             | Yes         | NIPDAU                               | N/A for Pkg Type                  | -40 to 125      | TLC2252IP                              |
| <a href="#">TLC2252MFKB</a>  | Active        | Production           | LCCC (FK)   20  | 55   TUBE             | No          | SNPB                                 | N/A for Pkg Type                  | -55 to 125      | 5962-<br>9564001Q2A<br>TLC2252<br>MFKB |
| TLC2252MFKB.A                | Active        | Production           | LCCC (FK)   20  | 55   TUBE             | No          | SNPB                                 | N/A for Pkg Type                  | -55 to 125      | 5962-<br>9564001Q2A<br>TLC2252<br>MFKB |
| <a href="#">TLC2252MJGB</a>  | Active        | Production           | CDIP (JG)   8   | 50   TUBE             | No          | SNPB                                 | N/A for Pkg Type                  | -55 to 125      | 9564001QPA<br>TLC2252M                 |
| TLC2252MJGB.A                | Active        | Production           | CDIP (JG)   8   | 50   TUBE             | No          | SNPB                                 | N/A for Pkg Type                  | -55 to 125      | 9564001QPA<br>TLC2252M                 |
| <a href="#">TLC2252MUB</a>   | Active        | Production           | CFP (U)   10    | 25   TUBE             | No          | SNPB                                 | N/A for Pkg Type                  | -55 to 125      | 9564001QHA<br>TLC2252M                 |
| TLC2252MUB.A                 | Active        | Production           | CFP (U)   10    | 25   TUBE             | No          | SNPB                                 | N/A for Pkg Type                  | -55 to 125      | 9564001QHA<br>TLC2252M                 |
| <a href="#">TLC2254AID</a>   | Active        | Production           | SOIC (D)   14   | 50   TUBE             | Yes         | NIPDAU                               | Level-1-260C-UNLIM                | -               | 2254AI                                 |
| TLC2254AID.B                 | Active        | Production           | SOIC (D)   14   | 50   TUBE             | Yes         | NIPDAU                               | Level-1-260C-UNLIM                | See TLC2254AID  | 2254AI                                 |
| TLC2254AIDG4                 | Active        | Production           | SOIC (D)   14   | 50   TUBE             | -           | Call TI                              | Call TI                           | See TLC2254AID  |  |
| <a href="#">TLC2254AIDR</a>  | Active        | Production           | SOIC (D)   14   | 2500   LARGE T&R      | Yes         | NIPDAU                               | Level-1-260C-UNLIM                | -               | 2254AI                                 |
| TLC2254AIDR.B                | Active        | Production           | SOIC (D)   14   | 2500   LARGE T&R      | Yes         | NIPDAU                               | Level-1-260C-UNLIM                | See TLC2254AIDR | 2254AI                                 |
| TLC2254AIDRG4                | Active        | Production           | SOIC (D)   14   | 2500   LARGE T&R      | -           | Call TI                              | Call TI                           | See TLC2254AIDR |  |
| <a href="#">TLC2254AIN</a>   | Active        | Production           | PDIP (N)   14   | 25   TUBE             | Yes         | NIPDAU                               | N/A for Pkg Type                  | -               | TLC2254AIN                             |
| TLC2254AIN.A                 | Active        | Production           | PDIP (N)   14   | 25   TUBE             | Yes         | NIPDAU                               | N/A for Pkg Type                  | See TLC2254AIN  | TLC2254AIN                             |
| <a href="#">TLC2254AIPW</a>  | Obsolete      | Production           | TSSOP (PW)   14 | -                     | -           | Call TI                              | Call TI                           | -               | Y2254A                                 |
| <a href="#">TLC2254AIPWR</a> | Active        | Production           | TSSOP (PW)   14 | 2000   LARGE T&R      | Yes         | NIPDAU                               | Level-1-260C-UNLIM                | -               | Y2254A                                 |

| Orderable part number        | Status<br>(1) | Material type<br>(2) | Package   Pins  | Package qty   Carrier | RoHS<br>(3) | Lead finish/<br>Ball material<br>(4) | MSL rating/<br>Peak reflow<br>(5) | Op temp (°C)     | Part marking<br>(6)                 |
|------------------------------|---------------|----------------------|-----------------|-----------------------|-------------|--------------------------------------|-----------------------------------|------------------|-------------------------------------|
| TLC2254AIPWR.B               | Active        | Production           | TSSOP (PW)   14 | 2000   LARGE T&R      | Yes         | NIPDAU                               | Level-1-260C-UNLIM                | See TLC2254AIPWR | Y2254A                              |
| TLC2254AIPWRG4               | Active        | Production           | TSSOP (PW)   14 | 2000   LARGE T&R      | -           | Call TI                              | Call TI                           | See TLC2254AIPWR |                                     |
| <a href="#">TLC2254AMFKB</a> | Active        | Production           | LCCC (FK)   20  | 55   TUBE             | No          | SNPB                                 | N/A for Pkg Type                  | -55 to 125       | 5962-9564004Q2A<br>TLC2254<br>AMFKB |
| TLC2254AMFKB.A               | Active        | Production           | LCCC (FK)   20  | 55   TUBE             | No          | SNPB                                 | N/A for Pkg Type                  | -55 to 125       | 5962-9564004Q2A<br>TLC2254<br>AMFKB |
| <a href="#">TLC2254AMWB</a>  | Active        | Production           | CFP (W)   14    | 25   TUBE             | No          | SNPB                                 | N/A for Pkg Type                  | -55 to 125       | 5962-9564004QD<br>A<br>TLC2254AMWB  |
| TLC2254AMWB.A                | Active        | Production           | CFP (W)   14    | 25   TUBE             | No          | SNPB                                 | N/A for Pkg Type                  | -55 to 125       | 5962-9564004QD<br>A<br>TLC2254AMWB  |
| <a href="#">TLC2254CDR</a>   | Active        | Production           | SOIC (D)   14   | 2500   LARGE T&R      | Yes         | NIPDAU                               | Level-1-260C-UNLIM                | 0 to 70          | TLC2254C                            |
| TLC2254CDR.B                 | Active        | Production           | SOIC (D)   14   | 2500   LARGE T&R      | Yes         | NIPDAU                               | Level-1-260C-UNLIM                | 0 to 70          | TLC2254C                            |
| <a href="#">TLC2254CN</a>    | Active        | Production           | PDIP (N)   14   | 25   TUBE             | Yes         | NIPDAU                               | N/A for Pkg Type                  | 0 to 70          | TLC2254CN                           |
| TLC2254CN.A                  | Active        | Production           | PDIP (N)   14   | 25   TUBE             | Yes         | NIPDAU                               | N/A for Pkg Type                  | 0 to 70          | TLC2254CN                           |
| <a href="#">TLC2254CPW</a>   | Active        | Production           | TSSOP (PW)   14 | 90   TUBE             | Yes         | NIPDAU                               | Level-1-260C-UNLIM                | 0 to 70          | P2254                               |
| TLC2254CPW.B                 | Active        | Production           | TSSOP (PW)   14 | 90   TUBE             | Yes         | NIPDAU                               | Level-1-260C-UNLIM                | 0 to 70          | P2254                               |
| <a href="#">TLC2254CPWR</a>  | Active        | Production           | TSSOP (PW)   14 | 2000   LARGE T&R      | Yes         | NIPDAU                               | Level-1-260C-UNLIM                | 0 to 70          | P2254                               |
| TLC2254CPWR.B                | Active        | Production           | TSSOP (PW)   14 | 2000   LARGE T&R      | Yes         | NIPDAU                               | Level-1-260C-UNLIM                | 0 to 70          | P2254                               |
| <a href="#">TLC2254ID</a>    | Active        | Production           | SOIC (D)   14   | 50   TUBE             | Yes         | NIPDAU                               | Level-1-260C-UNLIM                | -                | TLC2254I                            |
| TLC2254ID.B                  | Active        | Production           | SOIC (D)   14   | 50   TUBE             | Yes         | NIPDAU                               | Level-1-260C-UNLIM                | 0 to 70          | TLC2254I                            |
| TLC2254IDG4                  | Active        | Production           | SOIC (D)   14   | 50   TUBE             | -           | Call TI                              | Call TI                           | See TLC2254ID    |                                     |
| <a href="#">TLC2254IDR</a>   | Active        | Production           | SOIC (D)   14   | 2500   LARGE T&R      | Yes         | NIPDAU                               | Level-1-260C-UNLIM                | -                | TLC2254I                            |
| TLC2254IDR.B                 | Active        | Production           | SOIC (D)   14   | 2500   LARGE T&R      | Yes         | NIPDAU                               | Level-1-260C-UNLIM                | 0 to 70          | TLC2254I                            |
| <a href="#">TLC2254IN</a>    | Active        | Production           | PDIP (N)   14   | 25   TUBE             | Yes         | NIPDAU                               | N/A for Pkg Type                  | -                | TLC2254IN                           |
| TLC2254IN.B                  | Active        | Production           | PDIP (N)   14   | 25   TUBE             | Yes         | NIPDAU                               | N/A for Pkg Type                  | 0 to 70          | TLC2254IN                           |

| Orderable part number       | Status<br>(1) | Material type<br>(2) | Package   Pins | Package qty   Carrier | RoHS<br>(3) | Lead finish/<br>Ball material<br>(4) | MSL rating/<br>Peak reflow<br>(5) | Op temp (°C) | Part marking<br>(6)                |
|-----------------------------|---------------|----------------------|----------------|-----------------------|-------------|--------------------------------------|-----------------------------------|--------------|------------------------------------|
| <a href="#">TLC2254MFKB</a> | Active        | Production           | LCCC (FK)   20 | 55   TUBE             | No          | SNPB                                 | N/A for Pkg Type                  | -55 to 125   | 5962-9564002Q2A<br>TLC2254<br>MFKB |
| TLC2254MFKB.A               | Active        | Production           | LCCC (FK)   20 | 55   TUBE             | No          | SNPB                                 | N/A for Pkg Type                  | -55 to 125   | 5962-9564002Q2A<br>TLC2254<br>MFKB |
| <a href="#">TLC2254MWB</a>  | Active        | Production           | CFP (W)   14   | 25   TUBE             | No          | SNPB                                 | N/A for Pkg Type                  | -55 to 125   | 5962-9564002QD<br>A<br>TLC2254MWB  |
| TLC2254MWB.A                | Active        | Production           | CFP (W)   14   | 25   TUBE             | No          | SNPB                                 | N/A for Pkg Type                  | -55 to 125   | 5962-9564002QD<br>A<br>TLC2254MWB  |

(1) **Status:** For more details on status, see our [product life cycle](#).

(2) **Material type:** When designated, preproduction parts are prototypes/experimental devices, and are not yet approved or released for full production. Testing and final process, including without limitation quality assurance, reliability performance testing, and/or process qualification, may not yet be complete, and this item is subject to further changes or possible discontinuation. If available for ordering, purchases will be subject to an additional waiver at checkout, and are intended for early internal evaluation purposes only. These items are sold without warranties of any kind.

(3) **RoHS values:** Yes, No, RoHS Exempt. See the [TI RoHS Statement](#) for additional information and value definition.

(4) **Lead finish/Ball material:** Parts may have multiple material finish options. Finish options are separated by a vertical ruled line. Lead finish/Ball material values may wrap to two lines if the finish value exceeds the maximum column width.

(5) **MSL rating/Peak reflow:** The moisture sensitivity level ratings and peak solder (reflow) temperatures. In the event that a part has multiple moisture sensitivity ratings, only the lowest level per JEDEC standards is shown. Refer to the shipping label for the actual reflow temperature that will be used to mount the part to the printed circuit board.

(6) **Part marking:** There may be an additional marking, which relates to the logo, the lot trace code information, or the environmental category of the part.

Multiple part markings will be inside parentheses. Only one part marking contained in parentheses and separated by a "-" will appear on a part. If a line is indented then it is a continuation of the previous line and the two combined represent the entire part marking for that device.

**Important Information and Disclaimer:** The information provided on this page represents TI's knowledge and belief as of the date that it is provided. TI bases its knowledge and belief on information provided by third parties, and makes no representation or warranty as to the accuracy of such information. Efforts are underway to better integrate information from third parties. TI has taken and continues to take reasonable steps to provide representative

and accurate information but may not have conducted destructive testing or chemical analysis on incoming materials and chemicals. TI and TI suppliers consider certain information to be proprietary, and thus CAS numbers and other limited information may not be available for release.

In no event shall TI's liability arising out of such information exceed the total purchase price of the TI part(s) at issue in this document sold by TI to Customer on an annual basis.

**OTHER QUALIFIED VERSIONS OF TLC2252, TLC2252A, TLC2252AM, TLC2252M, TLC2254, TLC2254A, TLC2254AM, TLC2254M :**

- Catalog : [TLC2252A](#), [TLC2252](#), [TLC2254A](#), [TLC2254](#)
- Automotive : [TLC2252A-Q1](#), [TLC2252A-Q1](#), [TLC2254A-Q1](#), [TLC2254A-Q1](#)
- Enhanced Product : [TLC2252A-EP](#), [TLC2252A-EP](#), [TLC2254A-EP](#), [TLC2254A-EP](#)
- Military : [TLC2252M](#), [TLC2252AM](#), [TLC2254M](#), [TLC2254AM](#)

NOTE: Qualified Version Definitions:

- Catalog - TI's standard catalog product
- Automotive - Q100 devices qualified for high-reliability automotive applications targeting zero defects
- Enhanced Product - Supports Defense, Aerospace and Medical Applications
- Military - QML certified for Military and Defense Applications

**TAPE AND REEL INFORMATION**

**QUADRANT ASSIGNMENTS FOR PIN 1 ORIENTATION IN TAPE**



\*All dimensions are nominal

| Device       | Package Type | Package Drawing | Pins | SPQ  | Reel Diameter (mm) | Reel Width W1 (mm) | A0 (mm) | B0 (mm) | K0 (mm) | P1 (mm) | W (mm) | Pin1 Quadrant |
|--------------|--------------|-----------------|------|------|--------------------|--------------------|---------|---------|---------|---------|--------|---------------|
| TLC2252AIDR  | SOIC         | D               | 8    | 2500 | 330.0              | 12.4               | 6.4     | 5.2     | 2.1     | 8.0     | 12.0   | Q1            |
| TLC2252AIPWR | TSSOP        | PW              | 8    | 2000 | 330.0              | 12.4               | 7.0     | 3.6     | 1.6     | 8.0     | 12.0   | Q1            |
| TLC2252AQDR  | SOIC         | D               | 8    | 2500 | 330.0              | 12.5               | 6.4     | 5.2     | 2.1     | 8.0     | 12.0   | Q1            |
| TLC2252CDR   | SOIC         | D               | 8    | 2500 | 330.0              | 12.4               | 6.4     | 5.2     | 2.1     | 8.0     | 12.0   | Q1            |
| TLC2252CDR   | SOIC         | D               | 8    | 2500 | 330.0              | 12.4               | 6.4     | 5.2     | 2.1     | 8.0     | 12.0   | Q1            |
| TLC2252CPWR  | TSSOP        | PW              | 8    | 2000 | 330.0              | 12.4               | 7.0     | 3.6     | 1.6     | 8.0     | 12.0   | Q1            |
| TLC2252IDR   | SOIC         | D               | 8    | 2500 | 330.0              | 12.4               | 6.4     | 5.2     | 2.1     | 8.0     | 12.0   | Q1            |
| TLC2254AIDR  | SOIC         | D               | 14   | 2500 | 330.0              | 16.4               | 6.5     | 9.0     | 2.1     | 8.0     | 16.0   | Q1            |
| TLC2254AIPWR | TSSOP        | PW              | 14   | 2000 | 330.0              | 12.4               | 6.9     | 5.6     | 1.6     | 8.0     | 12.0   | Q1            |
| TLC2254CDR   | SOIC         | D               | 14   | 2500 | 330.0              | 16.4               | 6.5     | 9.0     | 2.1     | 8.0     | 16.0   | Q1            |
| TLC2254CPWR  | TSSOP        | PW              | 14   | 2000 | 330.0              | 12.4               | 6.9     | 5.6     | 1.6     | 8.0     | 12.0   | Q1            |
| TLC2254IDR   | SOIC         | D               | 14   | 2500 | 330.0              | 16.4               | 6.5     | 9.0     | 2.1     | 8.0     | 16.0   | Q1            |

**TAPE AND REEL BOX DIMENSIONS**

\*All dimensions are nominal

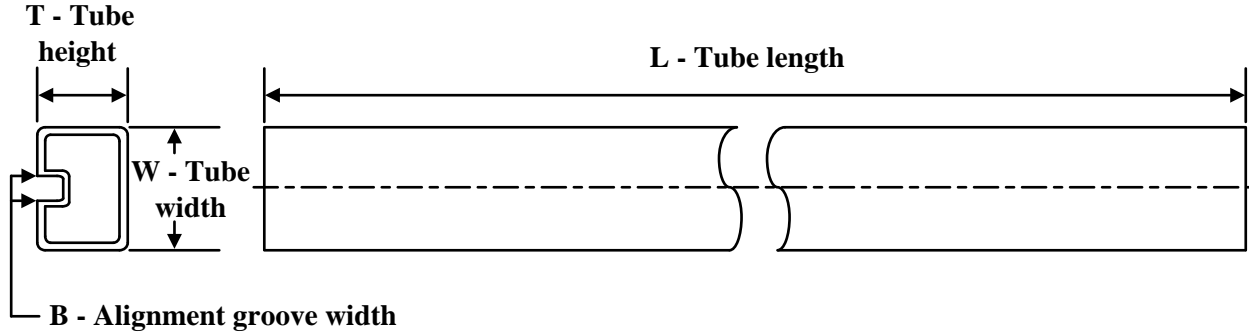
| Device       | Package Type | Package Drawing | Pins | SPQ  | Length (mm) | Width (mm) | Height (mm) |
|--------------|--------------|-----------------|------|------|-------------|------------|-------------|
| TLC2252AIDR  | SOIC         | D               | 8    | 2500 | 353.0       | 353.0      | 32.0        |
| TLC2252AIPWR | TSSOP        | PW              | 8    | 2000 | 353.0       | 353.0      | 32.0        |
| TLC2252AQDR  | SOIC         | D               | 8    | 2500 | 353.0       | 353.0      | 32.0        |
| TLC2252CDR   | SOIC         | D               | 8    | 2500 | 350.0       | 350.0      | 43.0        |
| TLC2252CDR   | SOIC         | D               | 8    | 2500 | 353.0       | 353.0      | 32.0        |
| TLC2252CPWR  | TSSOP        | PW              | 8    | 2000 | 353.0       | 353.0      | 32.0        |
| TLC2252IDR   | SOIC         | D               | 8    | 2500 | 353.0       | 353.0      | 32.0        |
| TLC2254AIDR  | SOIC         | D               | 14   | 2500 | 350.0       | 350.0      | 43.0        |
| TLC2254AIPWR | TSSOP        | PW              | 14   | 2000 | 353.0       | 353.0      | 32.0        |
| TLC2254CDR   | SOIC         | D               | 14   | 2500 | 333.2       | 345.9      | 28.6        |
| TLC2254CPWR  | TSSOP        | PW              | 14   | 2000 | 353.0       | 353.0      | 32.0        |
| TLC2254IDR   | SOIC         | D               | 14   | 2500 | 333.2       | 345.9      | 28.6        |

**TUBE**

\*All dimensions are nominal

| Device          | Package Name | Package Type | Pins | SPQ | L (mm) | W (mm) | T (µm) | B (mm) |
|-----------------|--------------|--------------|------|-----|--------|--------|--------|--------|
| 5962-9564001Q2A | FK           | LCCC         | 20   | 55  | 506.98 | 12.06  | 2030   | NA     |
| 5962-9564001QHA | U            | CFP          | 10   | 25  | 506.98 | 26.16  | 6220   | NA     |
| 5962-9564002Q2A | FK           | LCCC         | 20   | 55  | 506.98 | 12.06  | 2030   | NA     |
| 5962-9564002QDA | W            | CFP          | 14   | 25  | 506.98 | 26.16  | 6220   | NA     |
| 5962-9564003Q2A | FK           | LCCC         | 20   | 55  | 506.98 | 12.06  | 2030   | NA     |
| 5962-9564003QHA | U            | CFP          | 10   | 25  | 506.98 | 26.16  | 6220   | NA     |
| 5962-9564004Q2A | FK           | LCCC         | 20   | 55  | 506.98 | 12.06  | 2030   | NA     |
| 5962-9564004QDA | W            | CFP          | 14   | 25  | 506.98 | 26.16  | 6220   | NA     |
| TLC2252AID      | D            | SOIC         | 8    | 75  | 507    | 8      | 3940   | 4.32   |
| TLC2252AID      | D            | SOIC         | 8    | 75  | 505.46 | 6.76   | 3810   | 4      |
| TLC2252AID.B    | D            | SOIC         | 8    | 75  | 507    | 8      | 3940   | 4.32   |
| TLC2252AID.B    | D            | SOIC         | 8    | 75  | 505.46 | 6.76   | 3810   | 4      |
| TLC2252AIP      | P            | PDIP         | 8    | 50  | 506    | 13.97  | 11230  | 4.32   |
| TLC2252AIP.A    | P            | PDIP         | 8    | 50  | 506    | 13.97  | 11230  | 4.32   |
| TLC2252AMFKB    | FK           | LCCC         | 20   | 55  | 506.98 | 12.06  | 2030   | NA     |
| TLC2252AMFKB.A  | FK           | LCCC         | 20   | 55  | 506.98 | 12.06  | 2030   | NA     |
| TLC2252AMUB     | U            | CFP          | 10   | 25  | 506.98 | 26.16  | 6220   | NA     |
| TLC2252AMUB.A   | U            | CFP          | 10   | 25  | 506.98 | 26.16  | 6220   | NA     |
| TLC2252CD       | D            | SOIC         | 8    | 75  | 507    | 8      | 3940   | 4.32   |
| TLC2252CD       | D            | SOIC         | 8    | 75  | 505.46 | 6.76   | 3810   | 4      |
| TLC2252CD.B     | D            | SOIC         | 8    | 75  | 507    | 8      | 3940   | 4.32   |
| TLC2252CD.B     | D            | SOIC         | 8    | 75  | 505.46 | 6.76   | 3810   | 4      |
| TLC2252CP       | P            | PDIP         | 8    | 50  | 506    | 13.97  | 11230  | 4.32   |
| TLC2252CP.B     | P            | PDIP         | 8    | 50  | 506    | 13.97  | 11230  | 4.32   |
| TLC2252IP       | P            | PDIP         | 8    | 50  | 506    | 13.97  | 11230  | 4.32   |
| TLC2252IP.A     | P            | PDIP         | 8    | 50  | 506    | 13.97  | 11230  | 4.32   |
| TLC2252MFKB     | FK           | LCCC         | 20   | 55  | 506.98 | 12.06  | 2030   | NA     |
| TLC2252MFKB.A   | FK           | LCCC         | 20   | 55  | 506.98 | 12.06  | 2030   | NA     |
| TLC2252MUB      | U            | CFP          | 10   | 25  | 506.98 | 26.16  | 6220   | NA     |



| Device         | Package Name | Package Type | Pins | SPQ | L (mm) | W (mm) | T (µm) | B (mm) |
|----------------|--------------|--------------|------|-----|--------|--------|--------|--------|
| TLC2252MUB.A   | U            | CFP          | 10   | 25  | 506.98 | 26.16  | 6220   | NA     |
| TLC2254AID     | D            | SOIC         | 14   | 50  | 505.46 | 6.76   | 3810   | 4      |
| TLC2254AID.B   | D            | SOIC         | 14   | 50  | 505.46 | 6.76   | 3810   | 4      |
| TLC2254AIN     | N            | PDIP         | 14   | 25  | 506    | 13.97  | 11230  | 4.32   |
| TLC2254AIN.A   | N            | PDIP         | 14   | 25  | 506    | 13.97  | 11230  | 4.32   |
| TLC2254AMFKB   | FK           | LCCC         | 20   | 55  | 506.98 | 12.06  | 2030   | NA     |
| TLC2254AMFKB.A | FK           | LCCC         | 20   | 55  | 506.98 | 12.06  | 2030   | NA     |
| TLC2254AMWB    | W            | CFP          | 14   | 25  | 506.98 | 26.16  | 6220   | NA     |
| TLC2254AMWB.A  | W            | CFP          | 14   | 25  | 506.98 | 26.16  | 6220   | NA     |
| TLC2254CN      | N            | PDIP         | 14   | 25  | 506    | 13.97  | 11230  | 4.32   |
| TLC2254CN.A    | N            | PDIP         | 14   | 25  | 506    | 13.97  | 11230  | 4.32   |
| TLC2254CPW     | PW           | TSSOP        | 14   | 90  | 530    | 10.2   | 3600   | 3.5    |
| TLC2254CPW.B   | PW           | TSSOP        | 14   | 90  | 530    | 10.2   | 3600   | 3.5    |
| TLC2254ID      | D            | SOIC         | 14   | 50  | 505.46 | 6.76   | 3810   | 4      |
| TLC2254ID      | D            | SOIC         | 14   | 50  | 507    | 8      | 3940   | 4.32   |
| TLC2254ID.B    | D            | SOIC         | 14   | 50  | 507    | 8      | 3940   | 4.32   |
| TLC2254ID.B    | D            | SOIC         | 14   | 50  | 505.46 | 6.76   | 3810   | 4      |
| TLC2254IN      | N            | PDIP         | 14   | 25  | 506    | 13.97  | 11230  | 4.32   |
| TLC2254IN.B    | N            | PDIP         | 14   | 25  | 506    | 13.97  | 11230  | 4.32   |
| TLC2254MFKB    | FK           | LCCC         | 20   | 55  | 506.98 | 12.06  | 2030   | NA     |
| TLC2254MFKB.A  | FK           | LCCC         | 20   | 55  | 506.98 | 12.06  | 2030   | NA     |
| TLC2254MWB     | W            | CFP          | 14   | 25  | 506.98 | 26.16  | 6220   | NA     |
| TLC2254MWB.A   | W            | CFP          | 14   | 25  | 506.98 | 26.16  | 6220   | NA     |

# PACKAGE OUTLINE

## JG0008A

### CDIP - 5.08 mm max height

CERAMIC DUAL IN-LINE PACKAGE



4230036/A 09/2023

#### NOTES:

1. All linear dimensions are in millimeters. Any dimensions in parenthesis are for reference only. Dimensioning and tolerancing per ASME Y14.5M.
2. This drawing is subject to change without notice.
3. This package can be hermetically sealed with a ceramic lid using glass frit.
4. Index point is provided on cap for terminal identification.
5. Falls within MIL STD 1835 GDIP1-T8

# EXAMPLE BOARD LAYOUT

JG0008A

CDIP - 5.08 mm max height

CERAMIC DUAL IN-LINE PACKAGE



LAND PATTERN EXAMPLE  
NON SOLDER MASK DEFINED  
SCALE: 9X

4230036/A 09/2023

U0010A



**PACKAGE OUTLINE**

**CFP - 2.03 mm max height**

CERAMIC FLATPACK

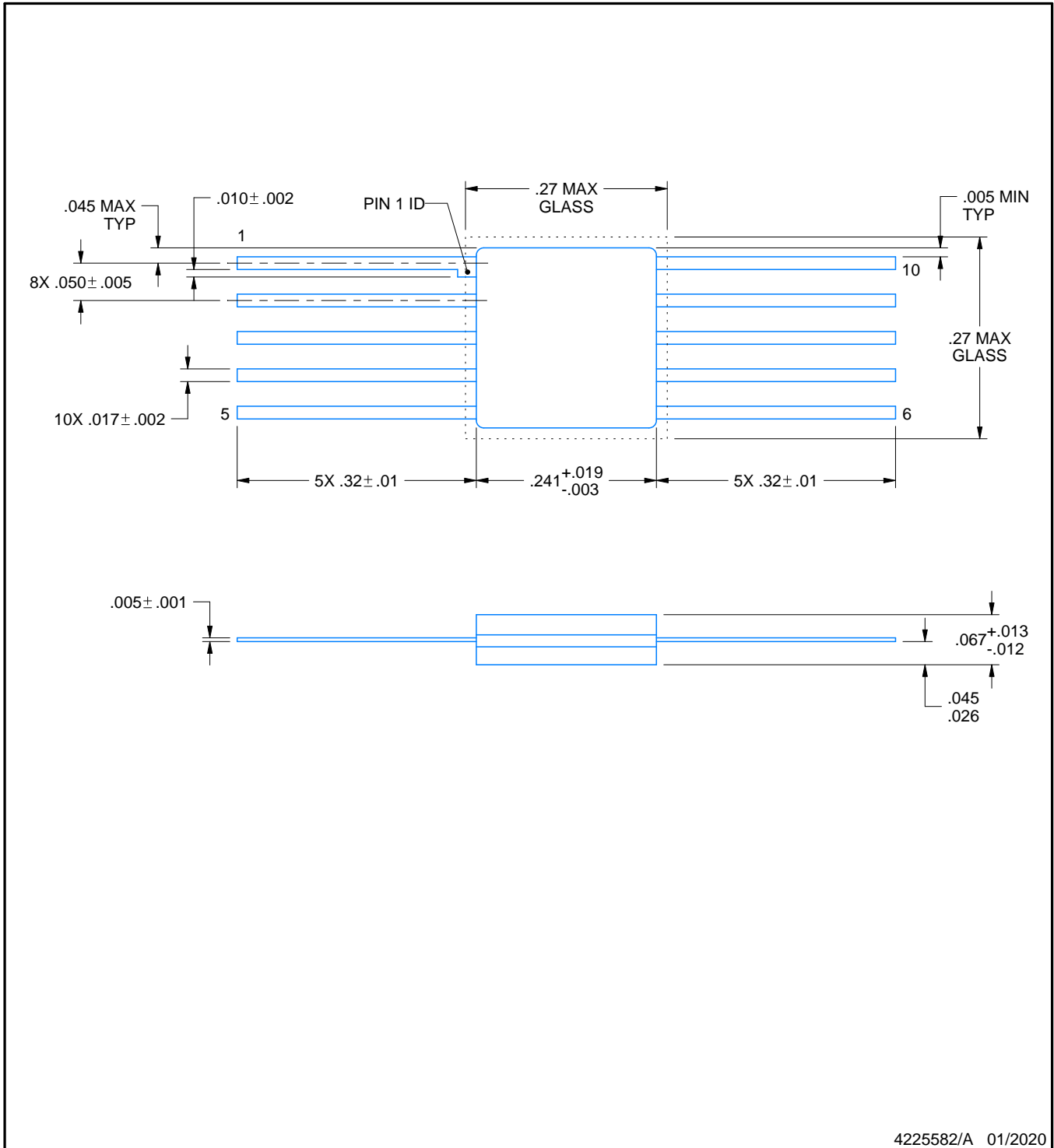

4225582/A 01/2020

NOTES:

1. All linear dimensions are in inches. Any dimensions in parenthesis are for reference only. Dimensioning and tolerancing per ASME Y14.5M.
2. This drawing is subject to change without notice.



# D0014A

# PACKAGE OUTLINE

## SOIC - 1.75 mm max height

SMALL OUTLINE INTEGRATED CIRCUIT



4220718/A 09/2016

### NOTES:

1. All linear dimensions are in millimeters. Dimensions in parenthesis are for reference only. Dimensioning and tolerancing per ASME Y14.5M.
2. This drawing is subject to change without notice.
3. This dimension does not include mold flash, protrusions, or gate burrs. Mold flash, protrusions, or gate burrs shall not exceed 0.15 mm, per side.
4. This dimension does not include interlead flash. Interlead flash shall not exceed 0.43 mm, per side.
5. Reference JEDEC registration MS-012, variation AB.

# EXAMPLE BOARD LAYOUT

D0014A

SOIC - 1.75 mm max height

SMALL OUTLINE INTEGRATED CIRCUIT



LAND PATTERN EXAMPLE  
SCALE:8X



SOLDER MASK DETAILS

4220718/A 09/2016

NOTES: (continued)

- 6. Publication IPC-7351 may have alternate designs.
- 7. Solder mask tolerances between and around signal pads can vary based on board fabrication site.

# EXAMPLE STENCIL DESIGN

D0014A

SOIC - 1.75 mm max height

SMALL OUTLINE INTEGRATED CIRCUIT



SOLDER PASTE EXAMPLE  
BASED ON 0.125 mm THICK STENCIL  
SCALE:8X

4220718/A 09/2016

NOTES: (continued)

8. Laser cutting apertures with trapezoidal walls and rounded corners may offer better paste release. IPC-7525 may have alternate design recommendations.
9. Board assembly site may have different recommendations for stencil design.

W (R-GDFP-F14)

CERAMIC DUAL FLATPACK



- NOTES:
- A. All linear dimensions are in inches (millimeters).
  - B. This drawing is subject to change without notice.
  - C. This package can be hermetically sealed with a ceramic lid using glass frit.
  - D. Index point is provided on cap for terminal identification only.
  - E. Falls within MIL STD 1835 GDFP1-F14



## GENERIC PACKAGE VIEW

**FK 20**

**LCCC - 2.03 mm max height**

8.89 x 8.89, 1.27 mm pitch

LEADLESS CERAMIC CHIP CARRIER

This image is a representation of the package family, actual package may vary.  
Refer to the product data sheet for package details.



4229370VA\



D0008A

# PACKAGE OUTLINE

SOIC - 1.75 mm max height

SMALL OUTLINE INTEGRATED CIRCUIT



4214825/C 02/2019

## NOTES:

- Linear dimensions are in inches [millimeters]. Dimensions in parenthesis are for reference only. Controlling dimensions are in inches. Dimensioning and tolerancing per ASME Y14.5M.
- This drawing is subject to change without notice.
- This dimension does not include mold flash, protrusions, or gate burrs. Mold flash, protrusions, or gate burrs shall not exceed  $.006$  [0.15] per side.
- This dimension does not include interlead flash.
- Reference JEDEC registration MS-012, variation AA.

# EXAMPLE BOARD LAYOUT

D0008A

SOIC - 1.75 mm max height

SMALL OUTLINE INTEGRATED CIRCUIT



LAND PATTERN EXAMPLE  
 EXPOSED METAL SHOWN  
 SCALE:8X



SOLDER MASK DETAILS

4214825/C 02/2019

NOTES: (continued)

- 6. Publication IPC-7351 may have alternate designs.
- 7. Solder mask tolerances between and around signal pads can vary based on board fabrication site.

# EXAMPLE STENCIL DESIGN

D0008A

SOIC - 1.75 mm max height

SMALL OUTLINE INTEGRATED CIRCUIT



SOLDER PASTE EXAMPLE  
BASED ON .005 INCH [0.125 MM] THICK STENCIL  
SCALE:8X

4214825/C 02/2019

NOTES: (continued)

8. Laser cutting apertures with trapezoidal walls and rounded corners may offer better paste release. IPC-7525 may have alternate design recommendations.
9. Board assembly site may have different recommendations for stencil design.

P (R-PDIP-T8)

PLASTIC DUAL-IN-LINE PACKAGE



- NOTES:
- A. All linear dimensions are in inches (millimeters).
  - B. This drawing is subject to change without notice.
  - C. Falls within JEDEC MS-001 variation BA.

N (R-PDIP-T\*\*)

PLASTIC DUAL-IN-LINE PACKAGE

16 PINS SHOWN



- NOTES:
- A. All linear dimensions are in inches (millimeters).
  - B. This drawing is subject to change without notice.
  - Falls within JEDEC MS-001, except 18 and 20 pin minimum body length (Dim A).
  - The 20 pin end lead shoulder width is a vendor option, either half or full width.

PW0014A



**PACKAGE OUTLINE**  
**TSSOP - 1.2 mm max height**

SMALL OUTLINE PACKAGE



NOTES:

1. All linear dimensions are in millimeters. Any dimensions in parenthesis are for reference only. Dimensioning and tolerancing per ASME Y14.5M.
2. This drawing is subject to change without notice.
3. This dimension does not include mold flash, protrusions, or gate burrs. Mold flash, protrusions, or gate burrs shall not exceed 0.15 mm per side.
4. This dimension does not include interlead flash. Interlead flash shall not exceed 0.25 mm per side.
5. Reference JEDEC registration MO-153.

# EXAMPLE BOARD LAYOUT

PW0014A

TSSOP - 1.2 mm max height

SMALL OUTLINE PACKAGE



LAND PATTERN EXAMPLE  
EXPOSED METAL SHOWN  
SCALE: 10X



4220202/B 12/2023

NOTES: (continued)

- 6. Publication IPC-7351 may have alternate designs.
- 7. Solder mask tolerances between and around signal pads can vary based on board fabrication site.



# EXAMPLE STENCIL DESIGN

PW0014A

TSSOP - 1.2 mm max height

SMALL OUTLINE PACKAGE



SOLDER PASTE EXAMPLE  
BASED ON 0.125 mm THICK STENCIL  
SCALE: 10X

4220202/B 12/2023

NOTES: (continued)

8. Laser cutting apertures with trapezoidal walls and rounded corners may offer better paste release. IPC-7525 may have alternate design recommendations.
9. Board assembly site may have different recommendations for stencil design.

PW0008A



**PACKAGE OUTLINE**  
**TSSOP - 1.2 mm max height**

SMALL OUTLINE PACKAGE



4221848/A 02/2015

NOTES:

- All linear dimensions are in millimeters. Any dimensions in parenthesis are for reference only. Dimensioning and tolerancing per ASME Y14.5M.
- This drawing is subject to change without notice.
- This dimension does not include mold flash, protrusions, or gate burrs. Mold flash, protrusions, or gate burrs shall not exceed 0.15 mm per side.
- This dimension does not include interlead flash. Interlead flash shall not exceed 0.25 mm per side.
- Reference JEDEC registration MO-153, variation AA.

# EXAMPLE BOARD LAYOUT

PW0008A

TSSOP - 1.2 mm max height

SMALL OUTLINE PACKAGE



LAND PATTERN EXAMPLE  
SCALE:10X



SOLDER MASK DETAILS  
NOT TO SCALE

4221848/A 02/2015

NOTES: (continued)

- 6. Publication IPC-7351 may have alternate designs.
- 7. Solder mask tolerances between and around signal pads can vary based on board fabrication site.

# EXAMPLE STENCIL DESIGN

PW0008A

TSSOP - 1.2 mm max height

SMALL OUTLINE PACKAGE



SOLDER PASTE EXAMPLE  
BASED ON 0.125 mm THICK STENCIL  
SCALE:10X

4221848/A 02/2015

NOTES: (continued)

8. Laser cutting apertures with trapezoidal walls and rounded corners may offer better paste release. IPC-7525 may have alternate design recommendations.
9. Board assembly site may have different recommendations for stencil design.

## IMPORTANT NOTICE AND DISCLAIMER

TI PROVIDES TECHNICAL AND RELIABILITY DATA (INCLUDING DATASHEETS), DESIGN RESOURCES (INCLUDING REFERENCE DESIGNS), APPLICATION OR OTHER DESIGN ADVICE, WEB TOOLS, SAFETY INFORMATION, AND OTHER RESOURCES "AS IS" AND WITH ALL FAULTS, AND DISCLAIMS ALL WARRANTIES, EXPRESS AND IMPLIED, INCLUDING WITHOUT LIMITATION ANY IMPLIED WARRANTIES OF MERCHANTABILITY, FITNESS FOR A PARTICULAR PURPOSE OR NON-INFRINGEMENT OF THIRD PARTY INTELLECTUAL PROPERTY RIGHTS.

These resources are intended for skilled developers designing with TI products. You are solely responsible for (1) selecting the appropriate TI products for your application, (2) designing, validating and testing your application, and (3) ensuring your application meets applicable standards, and any other safety, security, regulatory or other requirements.

These resources are subject to change without notice. TI grants you permission to use these resources only for development of an application that uses the TI products described in the resource. Other reproduction and display of these resources is prohibited. No license is granted to any other TI intellectual property right or to any third party intellectual property right. TI disclaims responsibility for, and you fully indemnify TI and its representatives against any claims, damages, costs, losses, and liabilities arising out of your use of these resources.

TI's products are provided subject to [TI's Terms of Sale](#), [TI's General Quality Guidelines](#), or other applicable terms available either on [ti.com](#) or provided in conjunction with such TI products. TI's provision of these resources does not expand or otherwise alter TI's applicable warranties or warranty disclaimers for TI products. Unless TI explicitly designates a product as custom or customer-specified, TI products are standard, catalog, general purpose devices.

TI objects to and rejects any additional or different terms you may propose.

Copyright © 2026, Texas Instruments Incorporated

Last updated 10/2025