

# OPAx314-Q1 3-MHz, Low-Power, Low-Noise, RRIO, 1.8-V CMOS Operational Amplifier

## 1 Features

- Qualified for Automotive Applications
- AEC-Q100 Qualified With the Following Results:
  - Device Temperature Grade :  $-40^{\circ}\text{C}$  to  $+125^{\circ}\text{C}$   
Ambient Operating Temperature Range
  - Device HBM Classification Level 2
  - Device CDM Classification Level C6
- Low  $I_Q$ : 150  $\mu\text{A}/\text{ch}$
- Wide Supply Range: 1.8 V to 5.5 V
- Low Noise: 14  $\text{nV}/\sqrt{\text{Hz}}$  at 1 kHz
- Gain Bandwidth: 3 MHz
- Low Input Bias Current: 0.2 pA
- Low Offset Voltage: 0.5 mV
- Unity-Gain Stable
- Internal RF and EMI Filter
- Specified Temperature Range:  $-40^{\circ}\text{C}$  to  $+125^{\circ}\text{C}$

## 2 Applications

- Automotive Applications:
  - ADAS
  - Body Electronics and Lighting
  - Current Sensing
  - Battery Monitoring

## 3 Description

The OPAx314-Q1 series is a family of single-, and dual-, and quad-channel operational amplifiers (op amps) that represents a new generation of low-power, general-purpose CMOS amplifiers. Rail-to-rail input and output swings, low quiescent current (150  $\mu\text{A}$  typically at 5  $V_S$ ) combined with a wide bandwidth of 3 MHz, and very low noise (14  $\text{nV}/\sqrt{\text{Hz}}$  at 1 kHz) make this device family very attractive for a variety of battery-powered applications that require a good balance between cost and performance. The low-input bias current supports applications with megaohm source impedances.

The robust design of the OPAx314-Q1 series provides ease-of-use to the circuit designer: unity-gain stability with capacitive loads of up to 300 pF, an integrated RF and EMI rejection filter, no phase reversal in overdrive conditions, and high electrostatic discharge (ESD) protection (4-kV HBM).

The device is optimized for low-voltage operation as low as 1.8 V ( $\pm 0.9$  V) and up to 5.5 V ( $\pm 2.75$  V), and is specified over the full extended temperature range of  $-40^{\circ}\text{C}$  to  $+125^{\circ}\text{C}$ .

The single-channel device, OPA314-Q1, is offered in the SOT-23 package and the dual-channel device, OPA2314-Q1, is offered in the VSSOP (8) package. The quad-channel OPA4314-Q1 is available in the 14-pin TSSOP package.

### Device Information<sup>(1)</sup>

PART NUMBER	PACKAGE	BODY SIZE (NOM)
OPA314-Q1	SOT-23 (5)	2.90 mm x 1.60 mm
OPA2314-Q1	VSSOP (8)	4.90 mm x 3.91 mm
OPA4314-Q1	TSSOP (14)	5.00 mm x 4.40 mm

(1) For all available packages, see the orderable addendum at the end of the data sheet.

### EMIRR vs Frequency

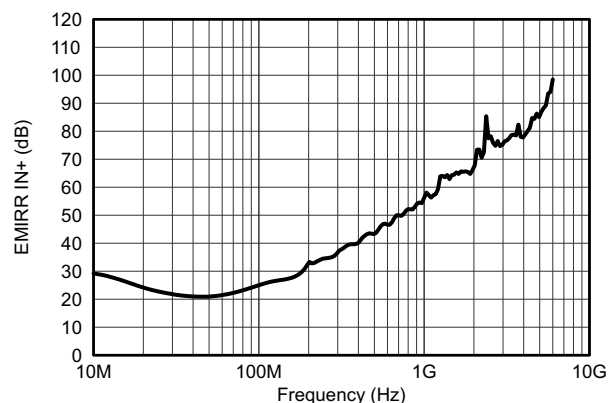

## Table of Contents

<b>1 Features</b> .....	<b>1</b>	7.2 Functional Block Diagram .....	19
<b>2 Applications</b> .....	<b>1</b>	7.3 Feature Description .....	19
<b>3 Description</b> .....	<b>1</b>	7.4 Device Functional Modes .....	20
<b>4 Revision History</b> .....	<b>2</b>	<b>8 Application and Implementation</b> .....	<b>21</b>
<b>5 Pin Configuration and Functions</b> .....	<b>3</b>	8.1 Application Information .....	21
<b>6 Specifications</b> .....	<b>6</b>	8.2 Typical Application .....	23
6.1 Absolute Maximum Ratings .....	6	<b>9 Power Supply Recommendations</b> .....	<b>25</b>
6.2 ESD Ratings .....	6	<b>10 Layout</b> .....	<b>26</b>
6.3 Recommended Operating Conditions .....	6	10.1 Layout Guidelines .....	26
6.4 Thermal Information: OPA314-Q1 .....	7	10.2 Layout Example .....	26
6.5 Thermal Information: OPA2314-Q1 .....	8	<b>11 Device and Documentation Support</b> .....	<b>27</b>
6.6 Thermal Information: OPA4314-Q1 .....	9	11.1 Documentation Support .....	27
6.7 Electrical Characteristics .....	10	11.2 Trademarks .....	27
6.8 Typical Characteristics .....	12	11.3 Electrostatic Discharge Caution .....	27
<b>7 Detailed Description</b> .....	<b>19</b>	11.4 Glossary .....	27
7.1 Overview .....	19	<b>12 Mechanical, Packaging, and Orderable Information</b> .....	<b>27</b>

## 4 Revision History

<b>Changes from Revision A (January 2015) to Revision B</b>	<b>Page</b>
• Added part number OPA4314-Q1 to document .....	1
• Added part number OPA4314-Q1 to the <i>Device Information</i> table .....	1
• Changed OPA2314-Q1 package from SOIC (8) to VSSOP (8) in the <i>Device Information</i> table .....	1
• Added OPA314-Q1 (SOT-23 package) throughout document .....	3
• Added pinout drawing for the OPA4314-Q1 device in the <i>Pin Configurations and Functions</i> section .....	5
• Added the Pin Functions: OPA4314-Q1 table to the <i>Pin Configurations and Functions</i> section .....	5
• Changed formatting of all <i>Thermal Information</i> table notes .....	7
• Added footnotes to all <i>Thermal Information</i> tables .....	7
• Added <i>Thermal Information: OPA4314-Q1</i> table .....	9
• Changed formatting of application report reference in the <i>EMI Susceptibility and Input Filtering</i> section .....	20
• Changed package drawing to reflect an example of the 5-pin SOT-23 package in the <i>Layout Example</i> section .....	26
• Changed formatting of <i>Related Documentation</i> section .....	27
• Added part number OPA4314-Q1 to the <i>Related Links</i> table .....	27

<b>Changes from Original (December 2014) to Revision A</b>	<b>Page</b>
• Changed the device status from <i>Product Preview</i> to <i>Production Data</i> .....	1

## 5 Pin Configuration and Functions

**OPA314-Q1 DBV Package  
5-Pin SOT-23  
Top View**

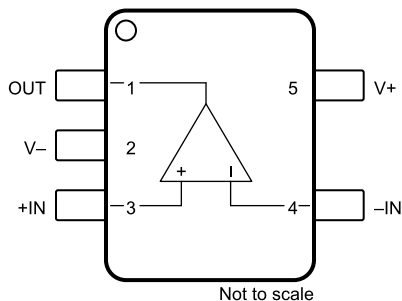

**Pin Functions: OPA314-Q1**

PIN		I/O	DESCRIPTION
NAME	NO.		
-IN	4	I	Inverting input
+IN	3	I	Noninverting input
OUT	1	O	Output
V-	2	—	Negative supply or ground (for single-supply operation).
V+	5	—	Positive supply

**OPA2314-Q1 DGK Package**  
**8-Pin VSSOP**  
**Top View**



**Pin Functions: OPA2314-Q1**

PIN		I/O	DESCRIPTION
NAME	NO.		
-IN A	2	I	Inverting input, channel A
+IN A	3	I	Noninverting input, channel A
-IN B	6	I	Inverting input, channel B
+IN B	5	I	Noninverting input, channel B
OUT A	1	O	Output, channel A
OUT B	7	O	Output, channel B
V-	4	—	Negative supply or ground (for single-supply operation).
V+	8	—	Positive supply

**OPA4314-Q1 DGK Package  
14-Pin TSSOP  
Top View**

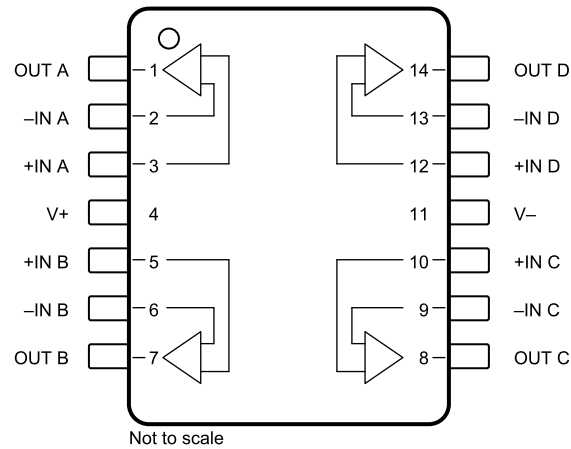

**Pin Functions: OPA4314-Q1**

PIN		I/O	DESCRIPTION
NAME	NO.		
-IN A	2	I	Inverting input, channel A
+IN A	3	I	Noninverting input, channel A
-IN B	6	I	Inverting input, channel B
+IN B	5	I	Noninverting input, channel B
-IN C	9	I	Inverting input, channel C
+IN C	10	I	Noninverting input, channel C
-IN D	13	I	Inverting input, channel D
+IN D	12	I	Noninverting input, channel D
OUT A	1	O	Output, channel A
OUT B	7	O	Output, channel B
OUT C	8	O	Output, channel C
OUT D	14	O	Output, channel D
V-	11	—	Negative supply or ground (for single-supply operation).
V+	4	—	Positive supply

## 6 Specifications

### 6.1 Absolute Maximum Ratings

over operating free-air temperature range (unless otherwise noted) <sup>(1)</sup>

		MIN	MAX	UNIT
Supply voltage		7		V
Voltage <sup>(2)</sup>	Signal input terminals	(V–) – 0.5	(V+) + 0.5	V
Current <sup>(2)</sup>	Signal input terminals	±10		mA
Output short-circuit <sup>(3)</sup>		Continuous		mA
Operating temperature, T <sub>A</sub>		–40	150	°C
Junction temperature, T <sub>J</sub>		150		°C
Storage temperature, T <sub>stg</sub>		–65	150	°C

- (1) Stresses beyond those listed under *Absolute Maximum Ratings* may cause permanent damage to the device. These are stress ratings only, which do not imply functional operation of the device at these or any other conditions beyond those indicated under *Recommended Operating Conditions*. Exposure to absolute-maximum-rated conditions for extended periods may affect device reliability.
- (2) Input terminals are diode-clamped to the power-supply rails. Input signals that can swing more than 0.5 V beyond the supply rails must be current limited to 10 mA or less.
- (3) Short-circuit to ground, one amplifier per package.

### 6.2 ESD Ratings

			VALUE	UNIT
V <sub>(ESD)</sub>	Electrostatic discharge	Human body model (HBM), per AEC Q100-002 <sup>(1)</sup>	±2000	V
		Charged device model (CDM), per AEC Q100-011	±1000	

- (1) AEC Q100-002 indicates HBM stressing is done in accordance with the ANSI/ESDA/JEDEC JS-001 specification.

### 6.3 Recommended Operating Conditions

over operating free-air temperature range (unless otherwise noted)

		MIN	NOM	MAX	UNIT
V <sub>S</sub>	Supply voltage	1.8 (±0.9)		5.5 (±2.75)	V
T <sub>A</sub>	Ambient operating temperature	–40		125	°C

## 6.4 Thermal Information: OPA314-Q1

THERMAL METRIC <sup>(1)</sup>		OPA314-Q1	UNIT
		DBV (SOT-23)	
		5 PINS	
$R_{\theta JA}$	Junction-to-ambient thermal resistance <sup>(2)</sup>	221.7	°C/W
$R_{\theta JC(top)}$	Junction-to-case(top) thermal resistance <sup>(3)</sup>	144.7	°C/W
$R_{\theta JB}$	Junction-to-board thermal resistance <sup>(4)</sup>	49.7	°C/W
$\Psi_{JT}$	Junction-to-top characterization parameter <sup>(5)</sup>	26.1	°C/W
$\Psi_{JB}$	Junction-to-board characterization parameter <sup>(6)</sup>	49	°C/W
$R_{\theta JC(bot)}$	Junction-to-case(bottom) thermal resistance <sup>(7)</sup>	N/A	°C/W

- (1) For more information about traditional and new thermal metrics, see the [Semiconductor and IC Package Thermal Metrics](#) application report.
- (2) The junction-to-ambient thermal resistance under natural convection is obtained in a simulation on a JEDEC-standard, high-K board, as specified in JESD51-7, in an environment described in JESD51-2a.
- (3) The junction-to-case (top) thermal resistance is obtained by simulating a cold plate test on the package top. No specific JEDEC-standard test exists, but a close description can be found in the ANSI SEMI standard G30-88.
- (4) The junction-to-board thermal resistance is obtained by simulating in an environment with a ring cold plate fixture to control the PCB temperature, as described in JESD51-8.
- (5) The junction-to-top characterization parameter,  $\Psi_{JT}$ , estimates the junction temperature of a device in a real system and is extracted from the simulation data for obtaining  $R_{\theta JA}$ , using a procedure described in JESD51-2a (sections 6 and 7).
- (6) The junction-to-board characterization parameter,  $\Psi_{JB}$ , estimates the junction temperature of a device in a real system and is extracted from the simulation data for obtaining  $R_{\theta JA}$ , using a procedure described in JESD51-2a (sections 6 and 7).
- (7) The junction-to-case (bottom) thermal resistance is obtained by simulating a cold plate test on the exposed (power) pad. No specific JEDEC standard test exists, but a close description can be found in the ANSI SEMI standard G30-88.

## 6.5 Thermal Information: OPA2314-Q1

THERMAL METRIC <sup>(1)</sup>		OPA2314-Q1	UNIT
		DGK (VSSOP)	
		8 PINS	
$R_{\theta JA}$	Junction-to-ambient thermal resistance <sup>(2)</sup>	138.4	°C/W
$R_{\theta JC(top)}$	Junction-to-case(top) thermal resistance <sup>(3)</sup>	89.5	°C/W
$R_{\theta JB}$	Junction-to-board thermal resistance <sup>(4)</sup>	78.6	°C/W
$\Psi_{JT}$	Junction-to-top characterization parameter <sup>(5)</sup>	29.9	°C/W
$\Psi_{JB}$	Junction-to-board characterization parameter <sup>(6)</sup>	78.1	°C/W
$R_{\theta JC(bot)}$	Junction-to-case(bottom) thermal resistance <sup>(7)</sup>	N/A	°C/W

- (1) For more information about traditional and new thermal metrics, see the [Semiconductor and IC Package Thermal Metrics](#) application report.
- (2) The junction-to-ambient thermal resistance under natural convection is obtained in a simulation on a JEDEC-standard, high-K board, as specified in JESD51-7, in an environment described in JESD51-2a.
- (3) The junction-to-case (top) thermal resistance is obtained by simulating a cold plate test on the package top. No specific JEDEC-standard test exists, but a close description can be found in the ANSI SEMI standard G30-88.
- (4) The junction-to-board thermal resistance is obtained by simulating in an environment with a ring cold plate fixture to control the PCB temperature, as described in JESD51-8.
- (5) The junction-to-top characterization parameter,  $\Psi_{JT}$ , estimates the junction temperature of a device in a real system and is extracted from the simulation data for obtaining  $R_{\theta JA}$ , using a procedure described in JESD51-2a (sections 6 and 7).
- (6) The junction-to-board characterization parameter,  $\Psi_{JB}$ , estimates the junction temperature of a device in a real system and is extracted from the simulation data for obtaining  $R_{\theta JA}$ , using a procedure described in JESD51-2a (sections 6 and 7).
- (7) The junction-to-case (bottom) thermal resistance is obtained by simulating a cold plate test on the exposed (power) pad. No specific JEDEC standard test exists, but a close description can be found in the ANSI SEMI standard G30-88.



## 6.6 Thermal Information: OPA4314-Q1

THERMAL METRIC <sup>(1)</sup>		OPA4314-Q1	UNIT
		PW (TSSOP)	
		14 PINS	
$R_{\theta JA}$	Junction-to-ambient thermal resistance <sup>(2)</sup>	121	°C/W
$R_{\theta JC(top)}$	Junction-to-case(top) thermal resistance <sup>(3)</sup>	49.4	°C/W
$R_{\theta JB}$	Junction-to-board thermal resistance <sup>(4)</sup>	62.8	°C/W
$\Psi_{JT}$	Junction-to-top characterization parameter <sup>(5)</sup>	5.9	°C/W
$\Psi_{JB}$	Junction-to-board characterization parameter <sup>(6)</sup>	62.2	°C/W
$R_{\theta JC(bot)}$	Junction-to-case(bottom) thermal resistance <sup>(7)</sup>	N/A	°C/W

- (1) For more information about traditional and new thermal metrics, see the [Semiconductor and IC Package Thermal Metrics](#) application report.
- (2) The junction-to-ambient thermal resistance under natural convection is obtained in a simulation on a JEDEC-standard, high-K board, as specified in JESD51-7, in an environment described in JESD51-2a.
- (3) The junction-to-case (top) thermal resistance is obtained by simulating a cold plate test on the package top. No specific JEDEC-standard test exists, but a close description can be found in the ANSI SEMI standard G30-88.
- (4) The junction-to-board thermal resistance is obtained by simulating in an environment with a ring cold plate fixture to control the PCB temperature, as described in JESD51-8.
- (5) The junction-to-top characterization parameter,  $\Psi_{JT}$ , estimates the junction temperature of a device in a real system and is extracted from the simulation data for obtaining  $R_{\theta JA}$ , using a procedure described in JESD51-2a (sections 6 and 7).
- (6) The junction-to-board characterization parameter,  $\Psi_{JB}$ , estimates the junction temperature of a device in a real system and is extracted from the simulation data for obtaining  $R_{\theta JA}$ , using a procedure described in JESD51-2a (sections 6 and 7).
- (7) The junction-to-case (bottom) thermal resistance is obtained by simulating a cold plate test on the exposed (power) pad. No specific JEDEC standard test exists, but a close description can be found in the ANSI SEMI standard G30-88.

## 6.7 Electrical Characteristics

at  $T_A = 25^\circ\text{C}$ ,  $R_L = 10\text{ k}\Omega$  connected to  $V_S / 2$ ,  $V_{CM} = V_S / 2$ , and  $V_{OUT} = V_S / 2$ ,  $V_S = 1.8\text{ V}$  to  $5.5\text{ V}$ , unless otherwise noted. The phrase *overtemperature* refers to values over the specified temperature range of  $T_A = -40^\circ\text{C}$  to  $125^\circ\text{C}$ .<sup>(1)</sup>

PARAMETER		TEST CONDITIONS	MIN	TYP	MAX	UNIT
<b>OFFSET VOLTAGE</b>						
$V_{OS}$	Input offset voltage	$V_{CM} = (V_{S+}) - 1.3\text{ V}$		0.5	2.5	mV
$dV_{OS}/dT$	Input offset voltage vs temperature			1		$\mu\text{V}/^\circ\text{C}$
PSRR	vs power supply	$V_{CM} = (V_{S+}) - 1.3\text{ V}$	78	92		dB
	Input offset voltage overtemperature		74			dB
	Channel separation, DC	At DC		10		$\mu\text{V}/\text{V}$
<b>INPUT VOLTAGE RANGE</b>						
$V_{CM}$	Common-mode voltage range		(V-) - 0.2		(V+) + 0.2	V
CMRR	Common-mode rejection ratio	$V_S = 1.8\text{ V}$ to $5.5\text{ V}$ , $(V_{S-}) - 0.2\text{ V} < V_{CM} < (V_{S+}) - 1.3\text{ V}$	75	96		dB
		$V_S = 5.5\text{ V}$ , $V_{CM} = -0.2\text{ V}$ to $5.7\text{ V}$ <sup>(2)</sup>	66	80		dB
	Common-mode rejection ratio overtemperature	$V_S = 1.8\text{ V}$ , $(V_{S-}) - 0.2\text{ V} < V_{CM} < (V_{S+}) - 1.3\text{ V}$	70	86		dB
		$V_S = 5.5\text{ V}$ , $(V_{S-}) - 0.2\text{ V} < V_{CM} < (V_{S+}) - 1.3\text{ V}$	73	90		dB
		$V_S = 5.5\text{ V}$ , $V_{CM} = -0.2\text{ V}$ to $5.7\text{ V}$ <sup>(2)</sup>	60			dB
<b>INPUT BIAS CURRENT</b>						
$I_B$	Input bias current			$\pm 0.2$	$\pm 10$	pA
	Input bias current overtemperature				$\pm 600$	pA
$I_{OS}$	Input offset current			$\pm 0.2$	$\pm 10$	pA
	Input offset current overtemperature				$\pm 600$	pA
<b>NOISE</b>						
	Input voltage noise (peak-to-peak)	$f = 0.1\text{ Hz}$ to $10\text{ Hz}$		5		$\mu\text{V}_{PP}$
$e_n$	Input voltage noise density	$f = 10\text{ kHz}$		13		$\text{nV}/\sqrt{\text{Hz}}$
		$f = 1\text{ kHz}$		14		$\text{nV}/\sqrt{\text{Hz}}$
$i_n$	Input current noise density	$f = 1\text{ kHz}$		5		$\text{fA}/\sqrt{\text{Hz}}$

- (1) Parameters with minimum or maximum specification limits are 100% production tested at  $25^\circ\text{C}$ , unless otherwise noted. Overtemperature limits are based on characterization and statistical analysis.
- (2) Specified by design and characterization; not production tested.

## Electrical Characteristics (continued)

at  $T_A = 25^\circ\text{C}$ ,  $R_L = 10\text{ k}\Omega$  connected to  $V_S / 2$ ,  $V_{CM} = V_S / 2$ , and  $V_{OUT} = V_S / 2$ ,  $V_S = 1.8\text{ V}$  to  $5.5\text{ V}$ , unless otherwise noted. The phrase *overtemperature* refers to values over the specified temperature range of  $T_A = -40^\circ\text{C}$  to  $125^\circ\text{C}$ .<sup>(1)</sup>

PARAMETER		TEST CONDITIONS	MIN	TYP	MAX	UNIT
<b>INPUT CAPACITANCE</b>						
$C_{IN}$	Differential	$V_S = 5\text{ V}$		1		pF
	Common-mode	$V_S = 5\text{ V}$		5		pF
<b>OPEN-LOOP GAIN</b>						
$A_{OL}$	Open-loop voltage gain	$V_S = 1.8\text{ V}$ , $0.2\text{ V} < V_O < (V+) - 0.2\text{ V}$ , $R_L = 10\text{ k}\Omega$	90	115		dB
		$V_S = 5.5\text{ V}$ , $0.2\text{ V} < V_O < (V+) - 0.2\text{ V}$ , $R_L = 10\text{ k}\Omega$	100	128		dB
		$V_S = 1.8\text{ V}$ , $0.5\text{ V} < V_O < (V+) - 0.5\text{ V}$ , $R_L = 2\text{ k}\Omega$ <sup>(2)</sup>	90	100		dB
		$V_S = 5.5\text{ V}$ , $0.5\text{ V} < V_O < (V+) - 0.5\text{ V}$ , $R_L = 2\text{ k}\Omega$ <sup>(2)</sup>	94	110		dB
Open-loop voltage gain overtemperature	$V_S = 5.5\text{ V}$ , $0.2\text{ V} < V_O < (V+) - 0.2\text{ V}$ , $R_L = 10\text{ k}\Omega$	90	110		dB	
	$V_S = 5.5\text{ V}$ , $0.5\text{ V} < V_O < (V+) - 0.2\text{ V}$ , $R_L = 2\text{ k}\Omega$		100		dB	
Phase margin	$V_S = 5\text{ V}$ , $G = 1$ , $R_L = 10\text{ k}\Omega$		65		degrees	
<b>FREQUENCY RESPONSE</b>						
GBW	Gain-bandwidth product	$V_S = 1.8\text{ V}$ , $R_L = 10\text{ k}\Omega$ , $C_L = 10\text{ pF}$		2.7		MHz
		$V_S = 5\text{ V}$ , $R_L = 10\text{ k}\Omega$ , $C_L = 10\text{ pF}$		3		MHz
SR	Slew rate <sup>(3)</sup>	$V_S = 5\text{ V}$ , $G = 1$		1.5		V/ $\mu\text{s}$
$t_S$	Settling time	To 0.1%, $V_S = 5\text{ V}$ , 2-V step, $G = 1$		2.3		$\mu\text{s}$
		To 0.01%, $V_S = 5\text{ V}$ , 2-V step, $G = 1$		3.1		$\mu\text{s}$
	Overload recovery time	$V_S = 5\text{ V}$ , $V_{IN} \times \text{Gain} > V_S$		5.2		$\mu\text{s}$
THD+N	Total harmonic distortion + noise <sup>(4)</sup>	$V_S = 5\text{ V}$ , $V_O = 1\text{ V}_{RMS}$ , $G = 1$ , $f = 1\text{ kHz}$ , $R_L = 10\text{ k}\Omega$		0.001%		
<b>OUTPUT</b>						
$V_O$	Voltage output swing from supply rails	$V_S = 1.8\text{ V}$ , $R_L = 10\text{ k}\Omega$		5	15	mV
		$V_S = 5.5\text{ V}$ , $R_L = 10\text{ k}\Omega$		5	20	mV
		$V_S = 1.8\text{ V}$ , $R_L = 2\text{ k}\Omega$		15	30	mV
		$V_S = 5.5\text{ V}$ , $R_L = 2\text{ k}\Omega$		22	40	mV
Voltage output swing from supply rails overtemperature	$V_S = 5.5\text{ V}$ , $R_L = 10\text{ k}\Omega$				30	mV
	$V_S = 5.5\text{ V}$ , $R_L = 2\text{ k}\Omega$			60		mV
$I_{SC}$	Short-circuit current	$V_S = 5\text{ V}$		$\pm 20$		mA
$R_O$	Open-loop output impedance	$V_S = 5.5\text{ V}$ , $f = 100\text{ Hz}$		570		$\Omega$
<b>POWER SUPPLY</b>						
$V_S$	Specified voltage range		1.8		5.5	V
$I_Q$	Quiescent current per amplifier	$V_S = 1.8\text{ V}$ , $I_O = 0\text{ mA}$		130	180	$\mu\text{A}$
		$V_S = 5\text{ V}$ , $I_O = 0\text{ mA}$		150	190	$\mu\text{A}$
	Quiescent current per amplifier overtemperature	$V_S = 5\text{ V}$ , $I_O = 0\text{ mA}$			220	$\mu\text{A}$
	Power-on time	$V_S = 0\text{ V}$ to $5\text{ V}$ , to 90% $I_Q$ level		44		$\mu\text{s}$
<b>TEMPERATURE</b>						
	Specified range		-40		125	$^\circ\text{C}$
	Operating range		-40		150	$^\circ\text{C}$
	Storage range		-65		150	$^\circ\text{C}$

(3) Signifies the slower value of the positive or negative slew rate.

(4) Third-order filter; bandwidth = 80 kHz at -3 dB.

## 6.8 Typical Characteristics

at  $T_A = 25^\circ\text{C}$ ,  $R_L = 10\text{ k}\Omega$  connected to  $V_S / 2$ ,  $V_{CM} = V_S / 2$ , and  $V_{OUT} = V_S / 2$ , unless otherwise noted

**Table 1. Characteristic Performance Measurements**

TITLE	FIGURE
Open-Loop Gain and Phase vs Frequency	<a href="#">Figure 1</a>
Open-Loop Gain vs Temperature	<a href="#">Figure 2</a>
Quiescent Current vs Supply Voltage	<a href="#">Figure 3</a>
Quiescent Current vs Temperature	<a href="#">Figure 4</a>
Offset Voltage Production Distribution	<a href="#">Figure 5</a>
Offset Voltage Drift Distribution	<a href="#">Figure 6</a>
Offset Voltage vs Common-Mode Voltage (Maximum Supply)	<a href="#">Figure 7</a>
Offset Voltage vs Temperature	<a href="#">Figure 8</a>
CMRR and PSRR vs Frequency (RTI)	<a href="#">Figure 9</a>
CMRR and PSRR vs Temperature	<a href="#">Figure 10</a>
0.1-Hz to 10-Hz Input Voltage Noise (5.5 V)	<a href="#">Figure 11</a>
Input Voltage Noise Spectral Density vs Frequency (1.8 V, 5.5 V)	<a href="#">Figure 12</a>
Input Voltage Noise vs Common-Mode Voltage (5.5 V)	<a href="#">Figure 13</a>
Input Bias and Offset Current vs Temperature	<a href="#">Figure 14</a>
Open-Loop Output Impedance vs Frequency	<a href="#">Figure 15</a>
Maximum Output Voltage vs Frequency and Supply Voltage	<a href="#">Figure 16</a>
Output Voltage Swing vs Output Current (over Temperature)	<a href="#">Figure 17</a>
Closed-Loop Gain vs Frequency, $G = 1, -1, 10$ (1.8 V)	<a href="#">Figure 18</a>
Closed-Loop Gain vs Frequency, $G = 1, -1, 10$ (5.5 V)	<a href="#">Figure 19</a>
Small-Signal Overshoot vs Load Capacitance	<a href="#">Figure 20</a>
Small-Signal Step Response, Noninverting (1.8 V)	<a href="#">Figure 21</a>
Small-Signal Step Response, Noninverting ( 5.5 V)	<a href="#">Figure 22</a>
Large-Signal Step Response, Noninverting (1.8 V)	<a href="#">Figure 23</a>
Large-Signal Step Response, Noninverting ( 5.5 V)	<a href="#">Figure 24</a>
Positive Overload Recovery	<a href="#">Figure 25</a>
Negative Overload Recovery	<a href="#">Figure 26</a>
No Phase Reversal	<a href="#">Figure 27</a>
Channel Separation vs Frequency (Dual)	<a href="#">Figure 28</a>
THD+N vs Amplitude ( $G = 1, 2\text{ k}\Omega, 10\text{ k}\Omega$ )	<a href="#">Figure 29</a>
THD+N vs Amplitude ( $G = -1, 2\text{ k}\Omega, 10\text{ k}\Omega$ )	<a href="#">Figure 30</a>
THD+N vs Frequency ( $0.5\text{ V}_{RMS}, G = 1, 2\text{ k}\Omega, 10\text{ k}\Omega$ )	<a href="#">Figure 31</a>
EMIRR	<a href="#">Figure 32</a>

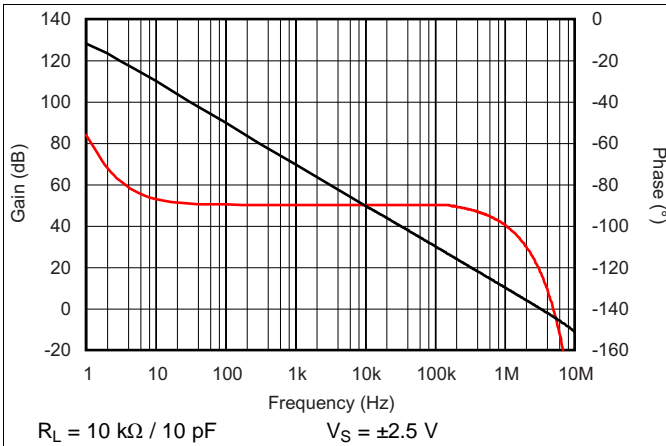

Figure 1. Open-loop Gain and Phase vs Frequency

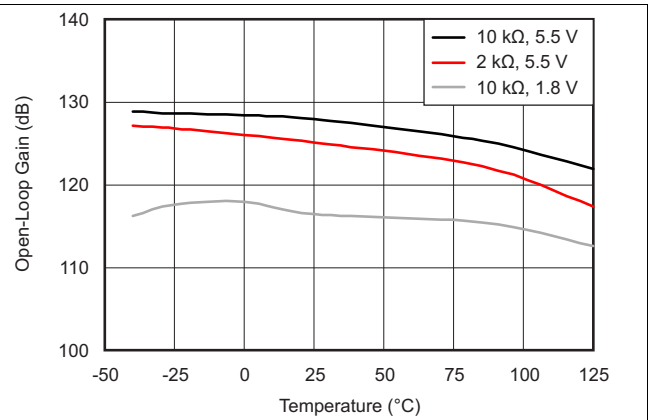

Figure 2. Open-Loop Gain vs Temperature

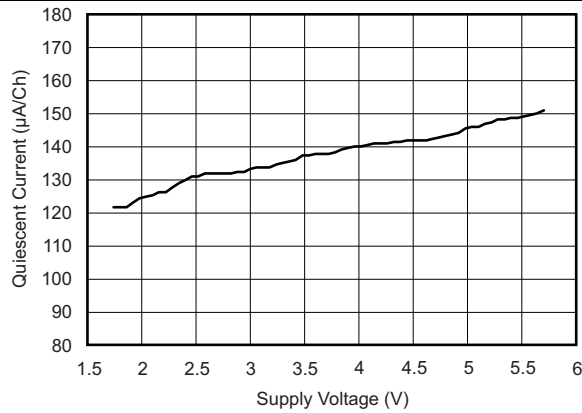

Figure 3. Quiescent Current vs Supply

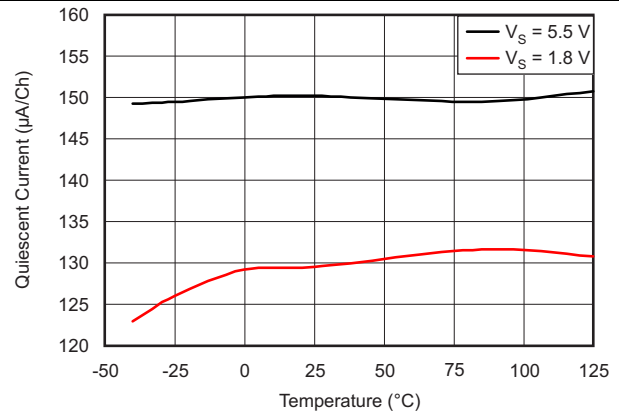

Figure 4. Quiescent Current vs Temperature

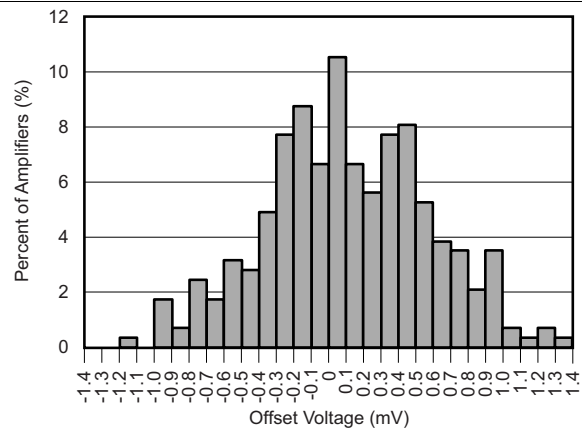

Figure 5. Offset Voltage Production Distribution

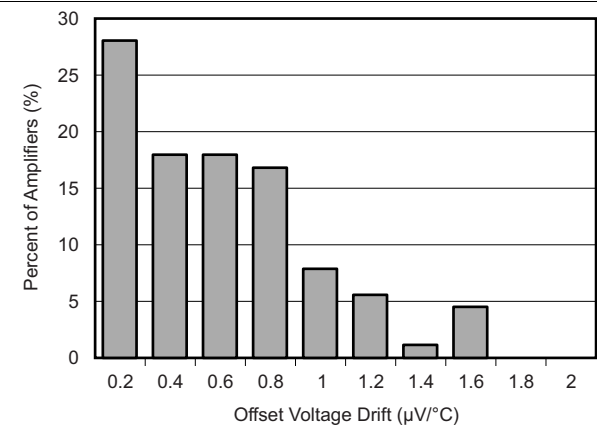

Figure 6. Offset Voltage Drift Distribution

OPA314-Q1, OPA2314-Q1, OPA4314-Q1

SLOS896B – DECEMBER 2014 – REVISED JANUARY 2017

www.ti.com

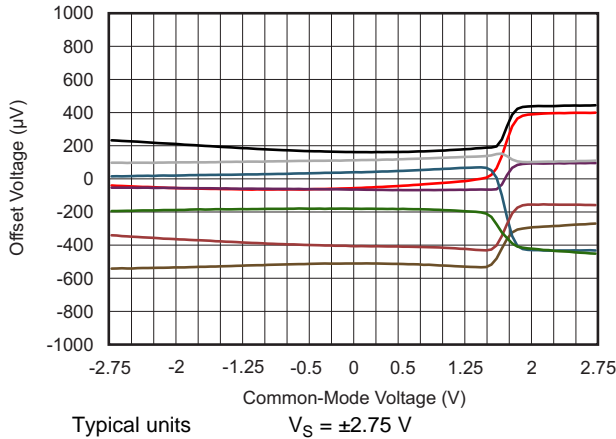

Figure 7. Offset Voltage vs Common-Mode Voltage

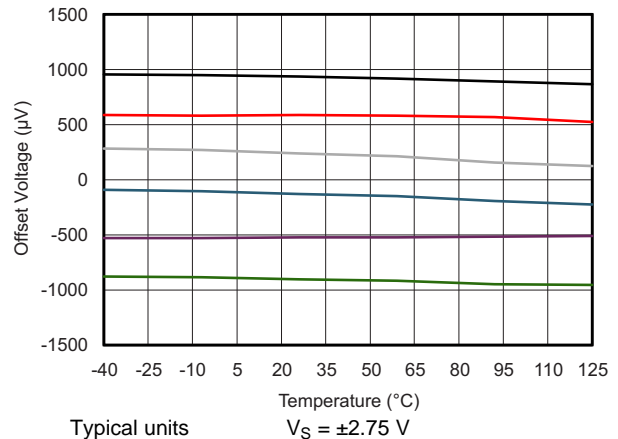

Figure 8. Offset Voltage vs Temperature

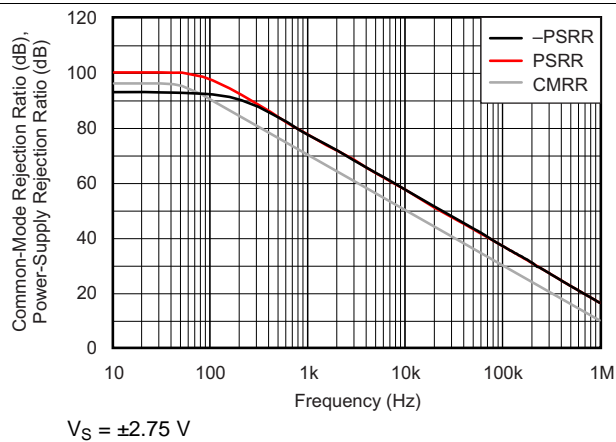

Figure 9. CMRR and PSRR vs Frequency (Referred-to-Input)

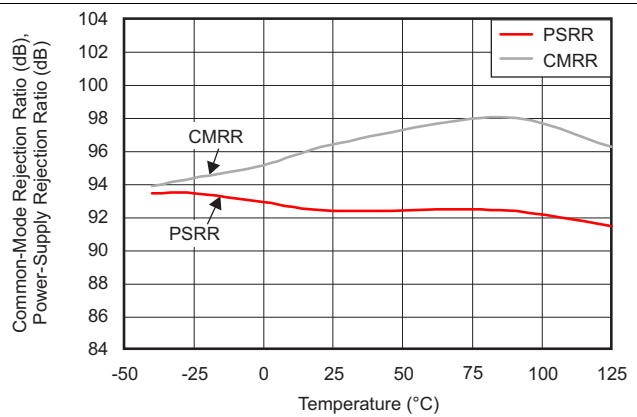

Figure 10. CMRR and PSRR vs Temperature

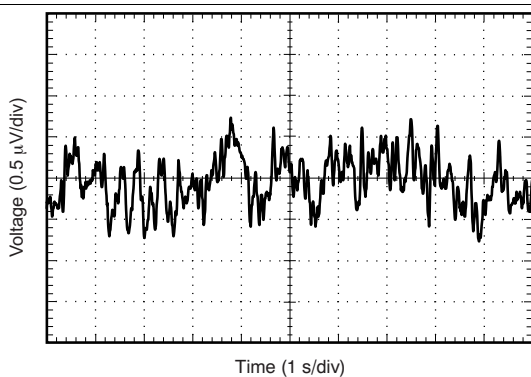

Figure 11. 0.1-Hz to 10-Hz Input Voltage Noise

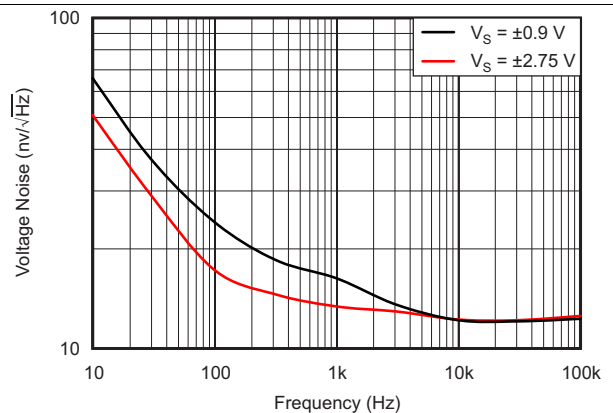

Figure 12. Input Voltage Noise Spectral Density vs Frequency

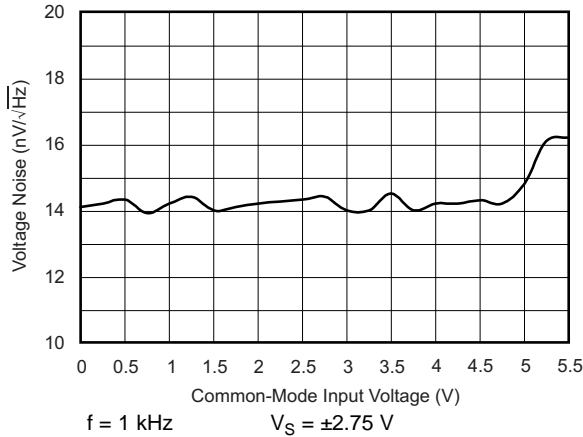

Figure 13. Voltage Noise vs Common-Mode Voltage

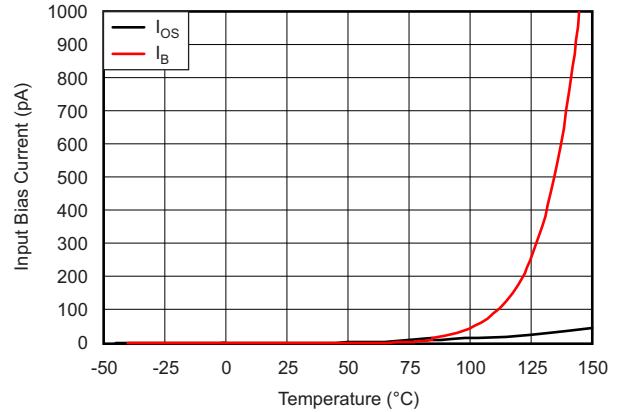

Figure 14. Input Bias and Offset Current vs Temperature

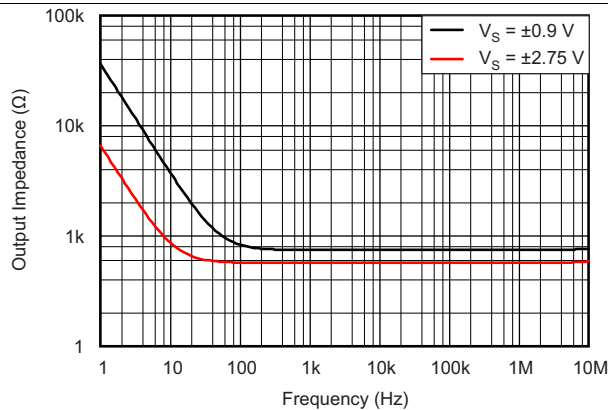

Figure 15. Open-Loop Output Impedance vs Frequency

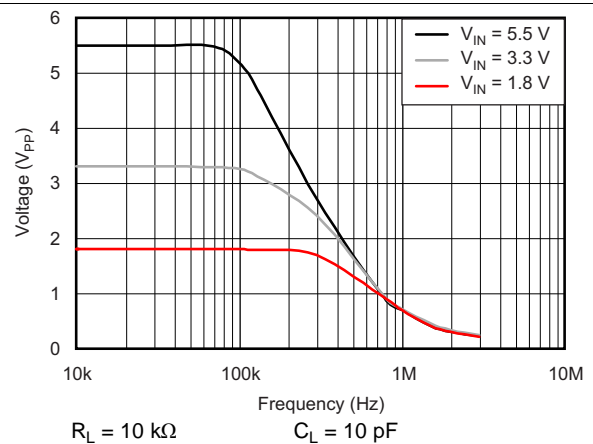

Figure 16. Maximum Output Voltage vs Frequency and Supply Voltage

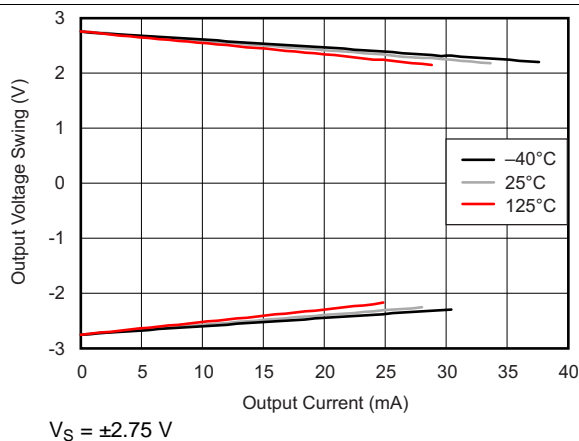

Figure 17. Output Voltage Swing vs Output Current (Overtemperature)

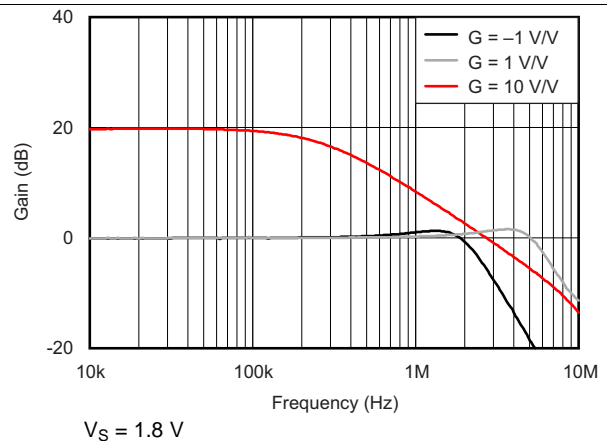

Figure 18. Closed-Loop Gain vs Frequency

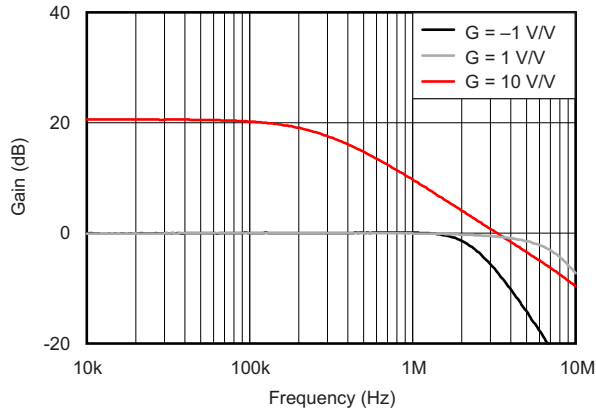

Figure 19. Closed-Loop Gain vs Frequency

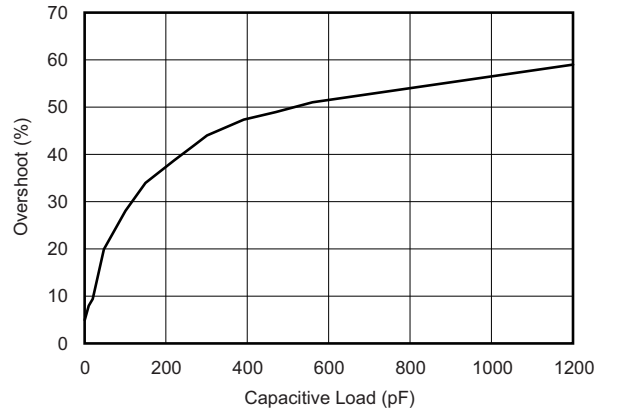

Figure 20. Small-Signal Overshoot vs Load Capacitance

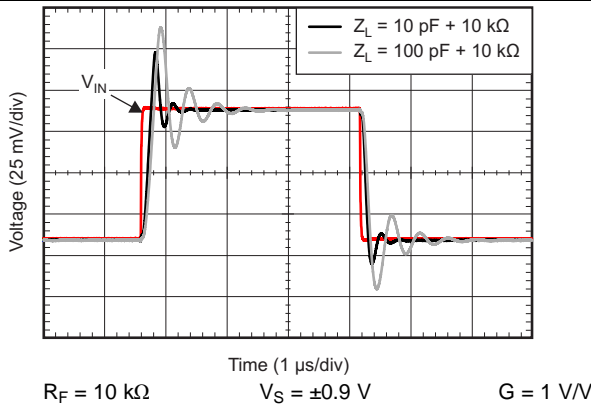

Figure 21. Small-Signal Pulse Response (Noninverting)

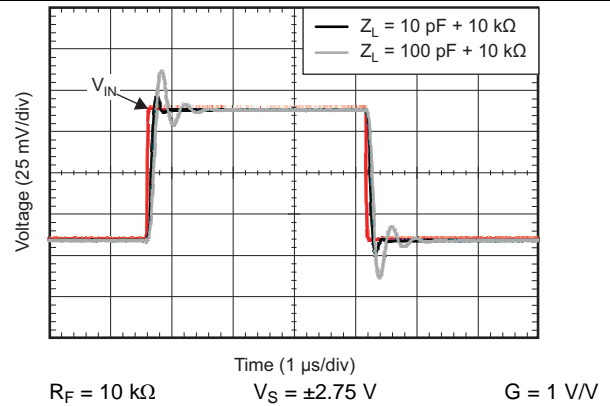

Figure 22. Small-Signal Pulse Response (Inverting)

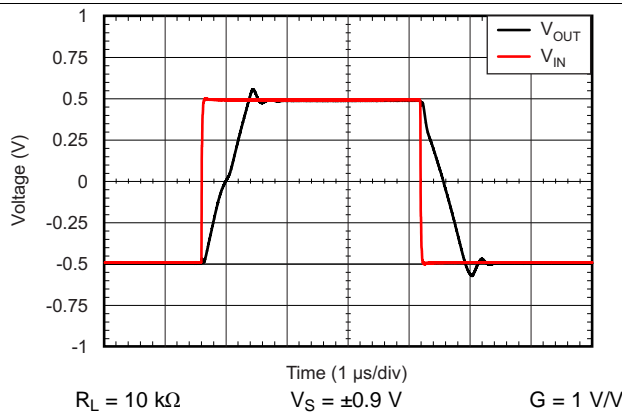

Figure 23. Large-Signal Pulse Response (Noninverting)

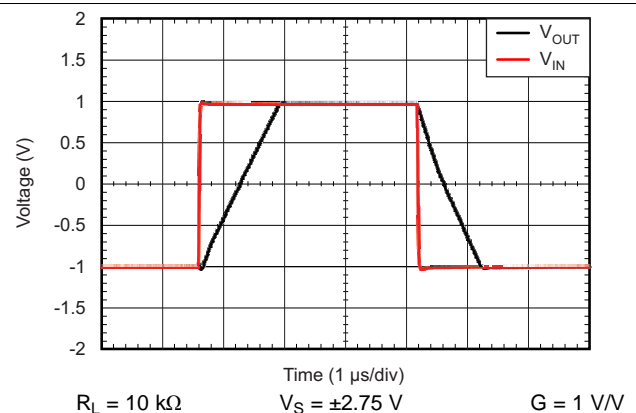

Figure 24. Large-Signal Pulse Response (Inverting)



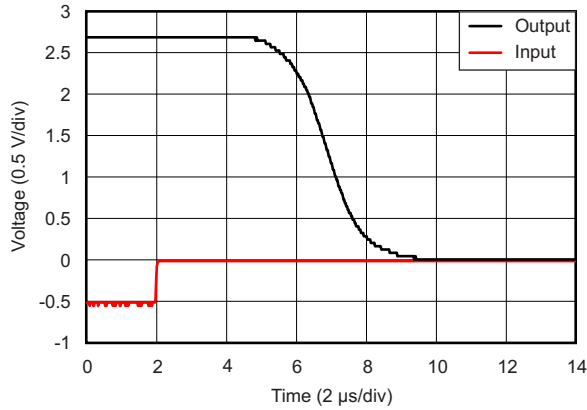

Figure 25. Positive Overload Recovery

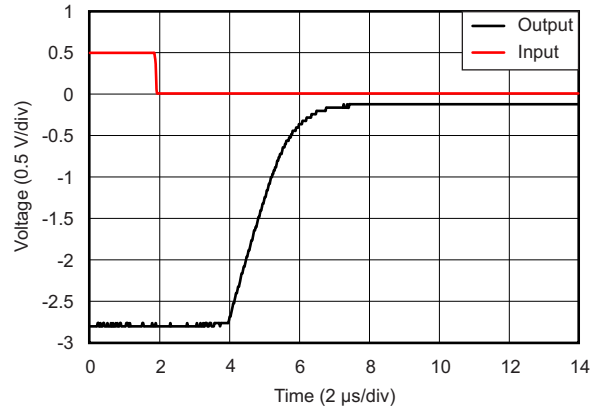

Figure 26. Negative Overload Recovery

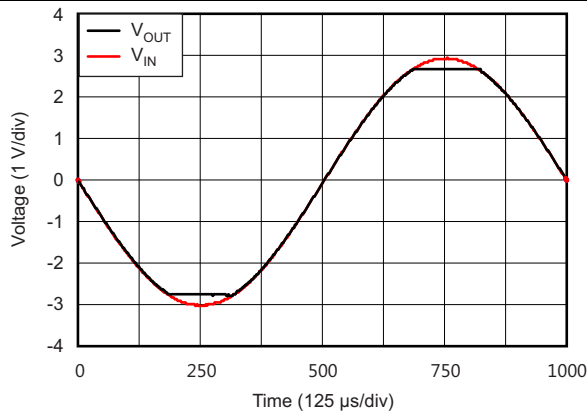

Figure 27. No Phase Reversal

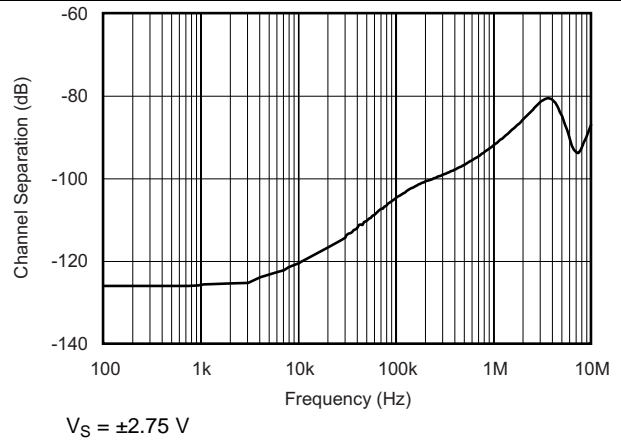

Figure 28. Channel Separation vs Frequency

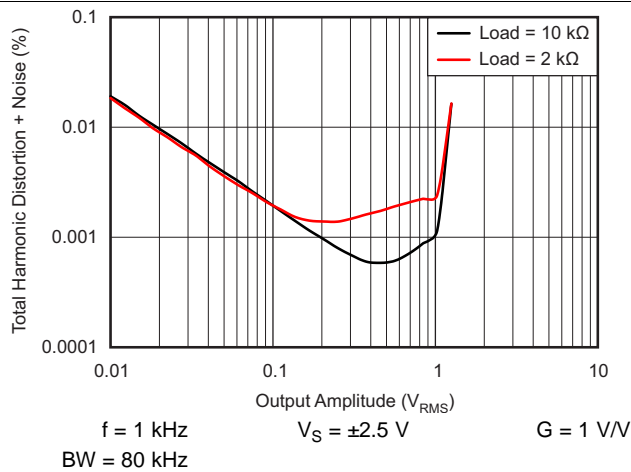

Figure 29. THD+N vs Output Amplitude (G = 1 V/V)

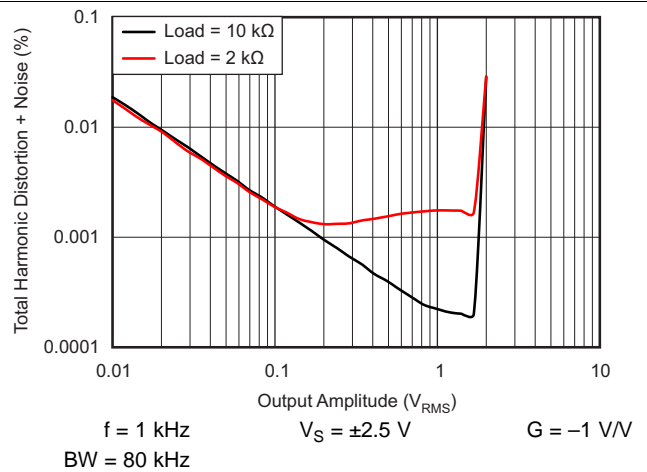
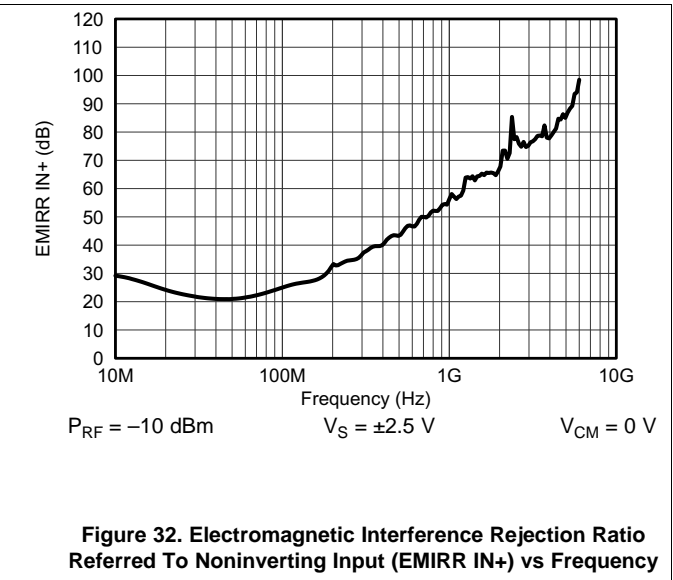
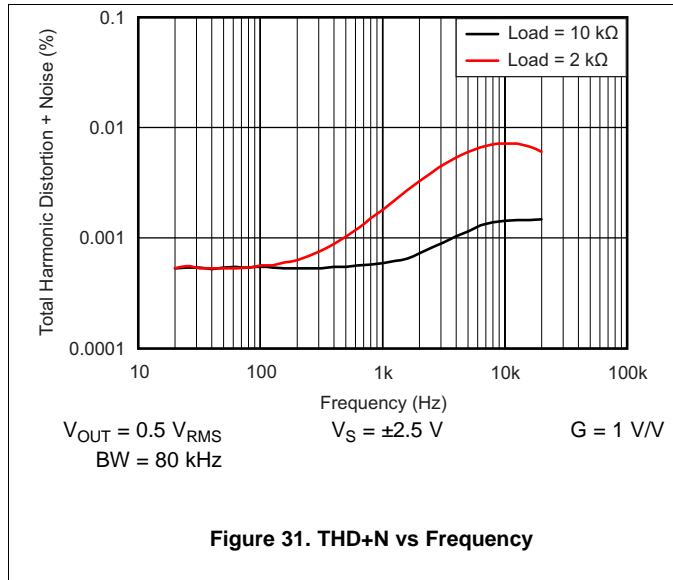

Figure 30. THD+N vs Output Amplitude (G = -1 V/V)

**OPA314-Q1, OPA2314-Q1, OPA4314-Q1**

SLOS896B – DECEMBER 2014 – REVISED JANUARY 2017

www.ti.com



## 7 Detailed Description

### 7.1 Overview

The OPAx314-Q1 is a family of low-power, rail-to-rail input and output operational amplifiers. These devices operate from 1.8 V to 5.5 V, are unity-gain stable, and are suitable for a wide range of general-purpose applications. The class AB output stage is capable of driving  $\leq 10\text{-k}\Omega$  loads connected to any point between  $V_+$  and ground. The input common-mode voltage range includes both rails and allows the OPAx314-Q1 series to be used in virtually any single-supply application. Rail-to-rail input and output swing significantly increases dynamic range, especially in low-supply applications, and makes them ideal for driving sampling analog-to-digital converters (ADCs).

### 7.2 Functional Block Diagram

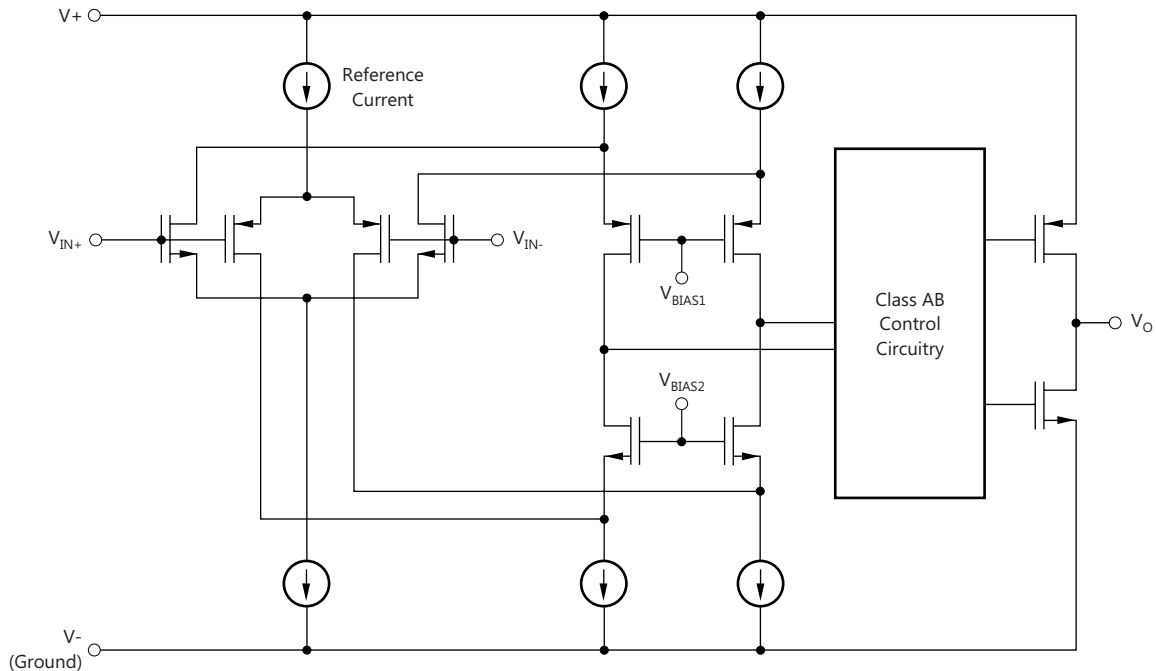

Copyright © 2017, Texas Instruments Incorporated

### 7.3 Feature Description

#### 7.3.1 Operating Voltage

The OPAx314-Q1 op-amp family is fully specified and ensured for operation from 1.8 V to 5.5 V. In addition, many specifications apply from  $-40^\circ\text{C}$  to  $+125^\circ\text{C}$ . Parameters that vary significantly with operating voltages or temperature are shown in the [Typical Characteristics](#) section. Power-supply pins must be bypassed with 0.01- $\mu\text{F}$  ceramic capacitors.

#### 7.3.2 Rail-to-Rail Input

The input common-mode voltage range of the OPAx314-Q1 family extends 200 mV beyond the supply rails. This performance is achieved with a complementary input stage: an N-channel input differential pair in parallel with a P-channel differential pair. The N-channel pair is active for input voltages close to the positive rail, typically  $(V_+) - 1.3\text{ V}$  to 200 mV above the positive supply. The P-channel pair is on for inputs from 200 mV below the negative supply to approximately  $(V_+) - 1.3\text{ V}$ . A small transition region exists, typically  $(V_+) - 1.4\text{ V}$  to  $(V_+) - 1.2\text{ V}$ , in which both pairs are on. This 200-mV transition region can vary up to 300 mV with process variation. Thus, the transition region (both stages on) can range from  $(V_+) - 1.7\text{ V}$  to  $(V_+) - 1.5\text{ V}$  on the low end, up to  $(V_+) - 1.1\text{ V}$  to  $(V_+) - 0.9\text{ V}$  on the high end. Within this transition region, PSRR, CMRR, offset voltage, offset drift, and THD may be degraded compared to device operation outside this region.

## Feature Description (continued)

### 7.3.3 Input and ESD Protection

The OPAx314-Q1 family incorporates internal electrostatic discharge (ESD) protection circuits on all pins. In the case of input and output pins, this protection primarily consists of current-steering diodes connected between the input and power-supply pins. These ESD protection diodes also provide in-circuit, input overdrive protection, as long as the current is limited to 10 mA as stated in the [Absolute Maximum Ratings](#) table. [Figure 33](#) shows how a series input resistor can be added to the driven input to limit the input current. The added resistor contributes thermal noise at the amplifier input and the value must be kept to a minimum in noise-sensitive applications.

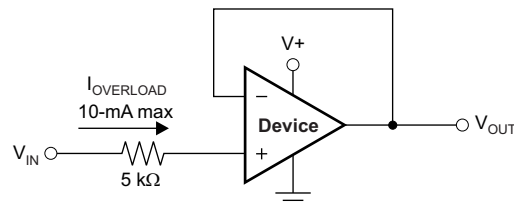

**Figure 33. Input Current Protection**

### 7.3.4 Common-Mode Rejection Ratio (CMRR)

CMRR for the OPAx314-Q1 family is specified in several ways so the best match for a given application may be used; see the [Electrical Characteristics](#) table. First, the CMRR of the device in the common-mode range below the transition region [ $V_{CM} < (V+) - 1.3 \text{ V}$ ] is given. This specification is the best indicator of the capability of the device when the application requires use of one of the differential input pairs. Second, the CMRR over the entire common-mode range is specified at ( $V_{CM} = -0.2 \text{ V}$  to  $5.7 \text{ V}$ ). This last value includes the variations seen through the transition region, as shown in [Figure 7](#).

### 7.3.5 EMI Susceptibility and Input Filtering

Op amps vary with regard to the susceptibility of the device to electromagnetic interference (EMI). If conducted EMI enters the op-amp, the dc offset observed at the amplifier output may shift from the nominal value while EMI is present. This shift is a result of signal rectification associated with the internal semiconductor junctions. While all op-amp pin functions can be affected by EMI, the signal input pins are likely to be the most susceptible. The OPAx314-Q1 family incorporates an internal input low-pass filter that reduces the amplifiers response to EMI. Both common-mode and differential mode filtering are provided by this filter. The filter is designed for a cutoff frequency of approximately 80 MHz (–3 dB), with a roll-off of 20 dB per decade.

Texas Instruments has developed the ability to accurately measure and quantify the immunity of an operational amplifier over a broad frequency spectrum extending from 10 MHz to 6 GHz. The EMI rejection ratio (EMIRR) metric allows op amps to be directly compared by the EMI immunity. [Figure 32](#) shows the results of this testing on the OPAx314-Q1 family. Detailed information can also be found in the [EMI Rejection Ratio of Operational Amplifiers](#) application report, available for download from [www.ti.com](http://www.ti.com).

### 7.3.6 Rail-to-Rail Output

Designed as a micro-power, low-noise operational amplifier, the OPAx314-Q1 family delivers a robust output drive capability. A class AB output stage with common-source transistors is used to achieve full rail-to-rail output swing capability. For resistive loads up to 10 kΩ, the output swings typically to within 5 mV of either supply rail regardless of the power-supply voltage applied. Different load conditions change the ability of the amplifier to swing close to the rails; see [Figure 17](#).

## 7.4 Device Functional Modes

The OPAx314-Q1 family is powered on when the supply is connected. The device can operate as a single-supply operational amplifier or a dual-supply amplifier, depending on the application.

## 8 Application and Implementation

### NOTE

Information in the following applications sections is not part of the TI component specification, and TI does not warrant its accuracy or completeness. TI's customers are responsible for determining suitability of components for their purposes. Customers should validate and test their design implementation to confirm system functionality.

### 8.1 Application Information

The OPAx314-Q1 family is a low-power, rail-to-rail input and output operational amplifier specifically designed for portable applications. The device operates from 1.8 V to 5.5 V, is unity-gain stable, and suitable for a wide range of general-purpose applications. The class AB output stage is capable of driving  $\leq 10\text{-k}\Omega$  loads connected to any point between  $V+$  and ground. The input common-mode voltage range includes both rails, and allows the OPAx314-Q1 family to be used in virtually any single-supply application. Rail-to-rail input and output swing significantly increases dynamic range, especially in low-supply applications, and makes the device ideal for driving sampling analog-to-digital converters (ADCs).

The OPAx314-Q1 family features a 3-MHz bandwidth and 1.5-V/ $\mu\text{s}$  slew rate with only 150- $\mu\text{A}$  supply current per channel, providing good AC performance at very low power consumption. DC applications are also well served with a very-low input noise voltage of 14 nV/ $\sqrt{\text{Hz}}$  at 1 kHz, low-input bias current (0.2 pA), and an input offset voltage of 0.5 mV (typical).

#### 8.1.1 General Configurations

When receiving low-level signals, limiting the bandwidth of the incoming signals into the system is often required. The simplest way to establish this limited bandwidth is to place an RC filter at the noninverting terminal of the amplifier, as shown in [Figure 34](#).

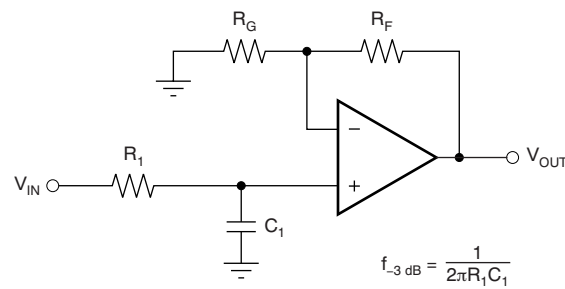

$$\frac{V_{OUT}}{V_{IN}} = \left(1 + \frac{R_F}{R_G}\right) \left(\frac{1}{1 + sR_1C_1}\right)$$

**Figure 34. Single-Pole Low-Pass Filter**

If additional attenuation is needed, a multiple pole filter is required. The Sallen-Key filter can be used for this task, as shown in [Figure 35](#). For best results, the amplifier must have a bandwidth that is eight to ten times the filter frequency bandwidth. Failure to follow this guideline can result in phase shift of the amplifier.

Application Information (continued)

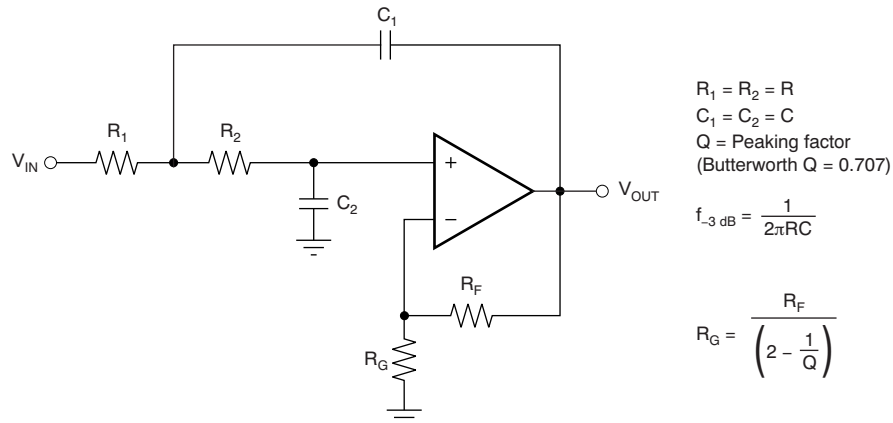

Figure 35. Two-Pole Low-Pass Sallen-Key Filter

8.1.2 Capacitive Load and Stability

The OPAx314-Q1 family is designed to be used in applications where driving a capacitive load is required. As with all op amps, specific instances can occur where the OPAx314-Q1 can become unstable. The particular op-amp circuit configuration, layout, gain, and output loading are some of the factors to consider when establishing whether or not an amplifier is stable in operation. An op-amp in the unity-gain (1 V/V) buffer configuration that drives a capacitive load exhibits a greater tendency to be unstable than an amplifier operated at a higher noise gain. The capacitive load, in conjunction with the op-amp output resistance, creates a pole within the feedback loop that degrades the phase margin. The degradation of the phase margin increases as the capacitive loading increases. When operating in the unity-gain configuration, the OPAx314-Q1 remains stable with a pure capacitive load up to approximately 1 nF. The equivalent series resistance (ESR) of some very large capacitors ( $C_L$  greater than 1  $\mu\text{F}$ ) is sufficient to alter the phase characteristics in the feedback loop such that the amplifier remains stable. Increasing the amplifier closed-loop gain allows the amplifier to drive increasingly larger capacitance. This increased capability is evident when observing the overshoot response of the amplifier at higher voltage gains; see , Figure 20.

One technique for increasing the capacitive load drive capability of the amplifier operating in a unity-gain configuration is to insert a small resistor, typically 10  $\Omega$  to 20  $\Omega$ , in series with the output, as shown in Figure 36. This resistor significantly reduces the overshoot and ringing associated with large capacitive loads. One possible problem with this technique, however, is that a voltage divider is created with the added series resistor and any resistor connected in parallel with the capacitive load. The voltage divider introduces a gain error at the output that reduces the output swing.

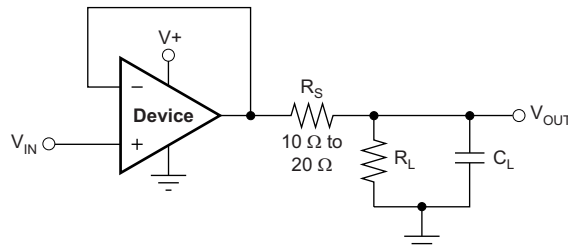

Figure 36. Improving Capacitive Load Drive

## 8.2 Typical Application

Some applications require differential signals. Figure 37 shows a simple circuit to convert a single-ended input of 0.1 V to 2.4 V into a differential output of  $\pm 2.3$  V on a single 2.7-V supply. The output range is intentionally limited to maximize linearity. The circuit is composed of two amplifiers. One amplifier functions as a buffer and creates a voltage ( $V_{OUT+}$ ). The second amplifier inverts the input and adds a reference voltage to generate  $V_{OUT-}$ . Both  $V_{OUT+}$  and  $V_{OUT-}$  range from 0.1 V to 2.4 V. The difference ( $V_{DIFF}$ ) is the difference between  $V_{OUT+}$  and  $V_{OUT-}$ . This makes the differential output voltage range 2.3 V.

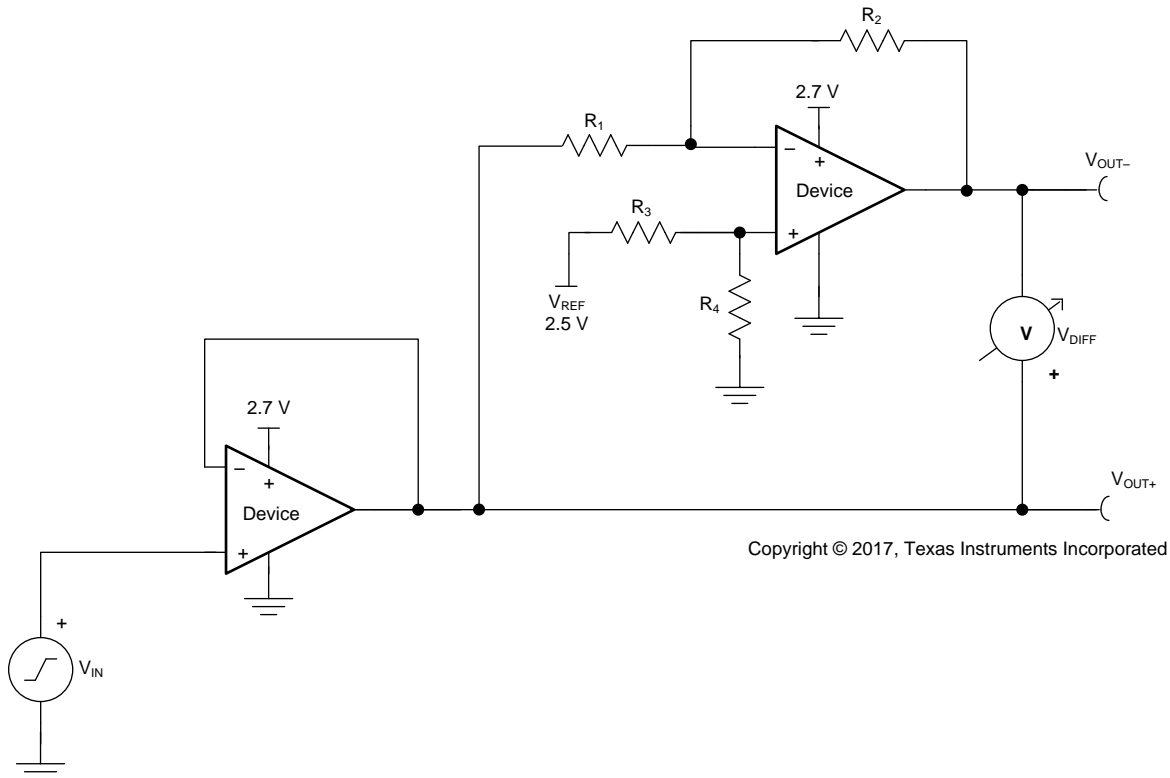

Figure 37. Schematic for a Single-Ended Input to Differential Output Conversion

### 8.2.1 Design Requirements

The design requirements are as follows:

- Supply voltage: 2.7 V
- Reference voltage: 2.5 V
- Input: 0.1 V to 2.4 V
- Output differential:  $\pm 2.3$  V
- Output common-mode voltage: 1.25 V
- Small-signal bandwidth: 1 MHz

### 8.2.2 Detailed Design Procedure

The circuit in Figure 37 takes a single-ended input signal,  $V_{IN}$ , and generates two output signals,  $V_{OUT+}$  and  $V_{OUT-}$  using two amplifiers and a reference voltage,  $V_{REF}$ .  $V_{OUT+}$  is the output of the first amplifier and is a buffered version of the input signal,  $V_{IN}$  (as shown in Equation 1).  $V_{OUT-}$  is the output of the second amplifier which uses  $V_{REF}$  to add an offset voltage to  $V_{IN}$  and feedback to add inverting gain. The transfer function for  $V_{OUT-}$  is given in Equation 2.

$$V_{OUT+} = V_{IN} \quad (1)$$

$$V_{OUT-} = V_{REF} \times \left( \frac{R_4}{R_3 + R_4} \right) \times \left( 1 + \frac{R_2}{R_1} \right) - V_{IN} \times \frac{R_2}{R_1} \quad (2)$$

## Typical Application (continued)

The differential output signal ( $V_{DIFF}$ ) is the difference between the two single-ended output signals ( $V_{OUT+}$  and  $V_{OUT-}$ ). Equation 3 shows the transfer function for  $V_{DIFF}$ . By applying the conditions that  $R_1 = R_2$  and  $R_3 = R_4$ , the transfer function is simplified into Equation 6. Using this configuration, the maximum input signal is equal to the reference voltage and the maximum output of each amplifier is equal to  $V_{REF}$ . The differential output range is  $2 \times V_{REF}$ . Furthermore, the common-mode voltage is one half of  $V_{REF}$  (see Equation 7).

$$V_{DIFF} = V_{OUT+} - V_{OUT-} = V_{IN} \times \left(1 + \frac{R_2}{R_1}\right) - V_{REF} \times \left(\frac{R_4}{R_3 + R_4}\right) \times \left(1 + \frac{R_2}{R_1}\right) \quad (3)$$

$$V_{OUT+} = V_{IN} \quad (4)$$

$$V_{OUT-} = V_{REF} - V_{IN} \quad (5)$$

$$V_{DIFF} = 2 \times V_{IN} - V_{REF} \quad (6)$$

$$V_{CM} = \left(\frac{V_{OUT+} + V_{OUT-}}{2}\right) = \frac{1}{2} V_{REF} \quad (7)$$

### 8.2.2.1 Amplifier Selection

Linearity over the input range is key for good dc accuracy. The common-mode input range and output swing limitations determine the linearity. In general, an amplifier with rail-to-rail input and output swing is required. Bandwidth is a key concern for this design, so the OPAx314-Q1 family is selected because the bandwidth is greater than the target of 1 MHz. The bandwidth and power ratio makes this device power efficient and the low offset and drift ensure good accuracy for moderate precision applications.

### 8.2.2.2 Passive Component Selection

Because the transfer function of  $V_{OUT-}$  is heavily reliant on resistors ( $R_1$ ,  $R_2$ ,  $R_3$ , and  $R_4$ ), use resistors with low tolerances to maximize performance and minimize error. This design uses resistors with resistance values of 49.9 k $\Omega$  and tolerances of 0.1%. However, if the noise of the system is a key parameter, smaller resistance values (6 k $\Omega$  or lower) can be selected to keep the overall system noise low. This ensures that the noise from the resistors is lower than the amplifier noise.

### 8.2.3 Application Curves

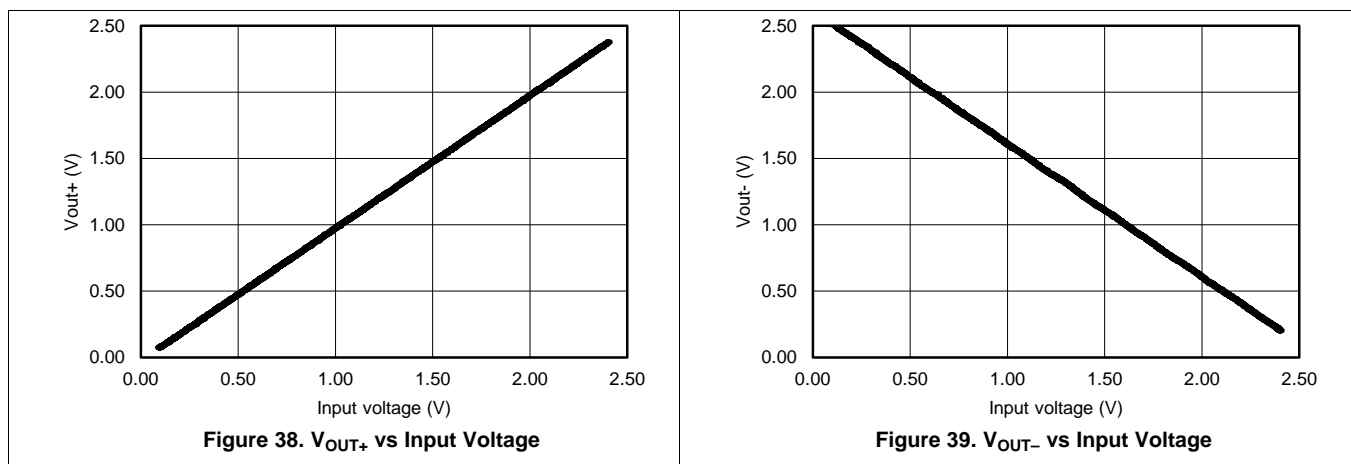



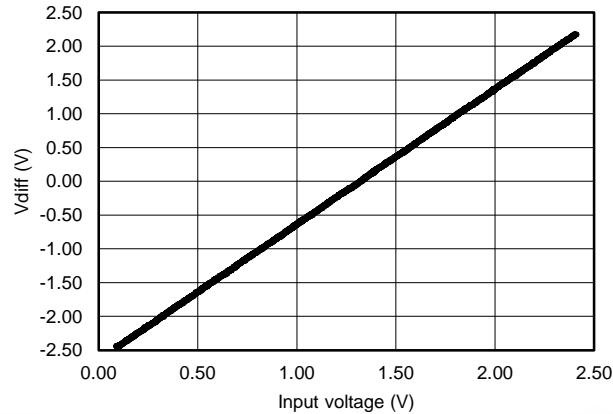

Figure 40. V<sub>DIFF</sub> vs Input Voltage

## 9 Power Supply Recommendations

The OPAx314-Q1 family is specified for operation from 1.8 V to 5.5 V ( $\pm 0.9$  V to  $\pm 2.75$  V); many specifications apply from  $-40^{\circ}\text{C}$  to  $+125^{\circ}\text{C}$ . The [Typical Characteristics](#) section presents parameters that can exhibit significant variance with regard to operating voltage or temperature.

### CAUTION

Supply voltages larger than 7 V can permanently damage the device (see the [Absolute Maximum Ratings](#) table).

Place 0.1- $\mu\text{F}$  bypass capacitors close to the power-supply pins to reduce errors coupling in from noisy or high-impedance power supplies. For more detailed information on bypass capacitor placement, see the [Layout Guidelines](#) section.

## 10 Layout

### 10.1 Layout Guidelines

For best operational performance of the device, use good PCB layout practices, including:

- Noise can propagate into analog circuitry through the power pins of the circuit as a whole and the operational amplifier. Bypass capacitors are used to reduce the coupled noise by providing low-impedance power sources local to the analog circuitry.
  - Connect low-ESR, 0.1- $\mu$ F ceramic bypass capacitors between each supply pin and ground, placed as close to the device as possible. A single bypass capacitor from V+ to ground is applicable for single-supply applications.
- Separate grounding for analog and digital portions of the circuitry is one of the simplest and most effective methods of noise suppression. One or more layers on multilayer PCBs are usually devoted to ground planes. A ground plane helps distribute heat and reduces EMI noise pickup. Make sure to physically separate digital and analog grounds, paying attention to the flow of the ground current.
- To reduce parasitic coupling, run the input traces as far away from the supply or output traces as possible. If these traces cannot be kept separate, crossing the sensitive trace perpendicularly is much better than crossing in parallel with the noisy trace.
- Place the external components as close to the device as possible. Keeping  $R_F$  and  $R_G$  close to the inverting input minimizes parasitic capacitance, as shown in [Figure 41](#).
- Keep the length of input traces as short as possible. Always remember that the input traces are the most sensitive part of the circuit.
- Consider a driven, low-impedance guard ring around the critical traces. A guard ring can significantly reduce leakage currents from nearby traces that are at different potentials.

### 10.2 Layout Example

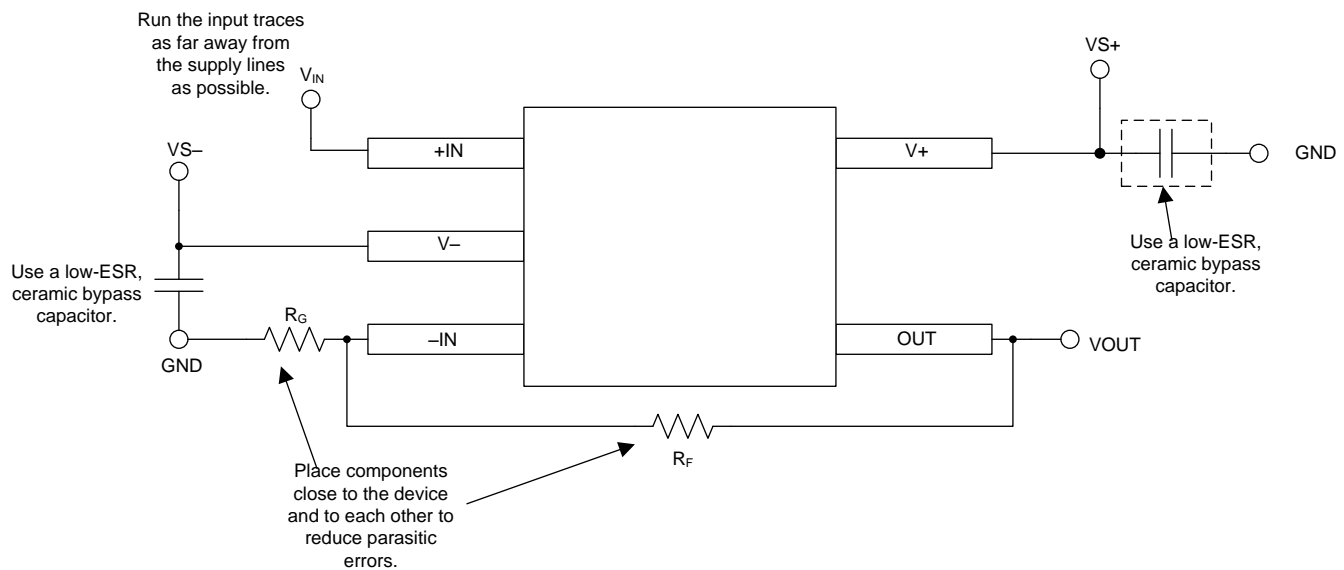

Copyright © 2017, Texas Instruments Incorporated

**Figure 41. Operational Amplifier Board Layout for Noninverting Configuration**

## 11 Device and Documentation Support

### 11.1 Documentation Support

#### 11.1.1 Related Documentation

For related documentation see the following:

- [EMI Rejection Ratio of Operational Amplifiers](#)

#### 11.1.2 Related Links

[Table 2](#) lists quick access links. Categories include technical documents, support and community resources, tools and software, and quick access to sample or buy.

**Table 2. Related Links**

PARTS	PRODUCT FOLDER	ORDER NOW	TECHNICAL DOCUMENTS	TOOLS & SOFTWARE	SUPPORT & COMMUNITY
OPA314-Q1	<a href="#">Click here</a>	<a href="#">Click here</a>	<a href="#">Click here</a>	<a href="#">Click here</a>	<a href="#">Click here</a>
OPA2314-Q1	<a href="#">Click here</a>	<a href="#">Click here</a>	<a href="#">Click here</a>	<a href="#">Click here</a>	<a href="#">Click here</a>
OPA4314-Q1	<a href="#">Click here</a>	<a href="#">Click here</a>	<a href="#">Click here</a>	<a href="#">Click here</a>	<a href="#">Click here</a>

### 11.2 Trademarks

### 11.3 Electrostatic Discharge Caution



These devices have limited built-in ESD protection. The leads should be shorted together or the device placed in conductive foam during storage or handling to prevent electrostatic damage to the MOS gates.

### 11.4 Glossary

[SLYZ022](#) — *TI Glossary*.

This glossary lists and explains terms, acronyms, and definitions.

## 12 Mechanical, Packaging, and Orderable Information

The following pages include mechanical, packaging, and orderable information. This information is the most current data available for the designated devices. This data is subject to change without notice and revision of this document. For browser-based versions of this data sheet, refer to the left-hand navigation.

**PACKAGING INFORMATION**

Orderable part number	Status (1)	Material type (2)	Package   Pins	Package qty   Carrier	RoHS (3)	Lead finish/ Ball material (4)	MSL rating/ Peak reflow (5)	Op temp (°C)	Part marking (6)
<a href="#">OPA2314AQDRQ1</a>	Active	Production	SOIC (D)   8	2500   LARGE T&R	Yes	NIPDAU	Level-3-260C-168 HR	-40 to 125	O2314Q
OPA2314AQDRQ1.A	Active	Production	SOIC (D)   8	2500   LARGE T&R	Yes	NIPDAU	Level-3-260C-168 HR	-40 to 125	O2314Q
<a href="#">OPA314AQDBVRQ1</a>	Active	Production	SOT-23 (DBV)   5	3000   LARGE T&R	Yes	NIPDAU   SN	Level-2-260C-1 YEAR	-40 to 125	14ZD
OPA314AQDBVRQ1.B	Active	Production	SOT-23 (DBV)   5	3000   LARGE T&R	Yes	NIPDAU	Level-2-260C-1 YEAR	-40 to 125	14ZD
<a href="#">OPA314AQDBVTQ1</a>	Active	Production	SOT-23 (DBV)   5	250   SMALL T&R	Yes	NIPDAU   SN	Level-2-260C-1 YEAR	-40 to 125	14ZD
OPA314AQDBVTQ1.B	Active	Production	SOT-23 (DBV)   5	250   SMALL T&R	Yes	NIPDAU	Level-2-260C-1 YEAR	-40 to 125	14ZD
<a href="#">OPA4314AQPWRQ1</a>	Active	Production	TSSOP (PW)   14	2000   LARGE T&R	Yes	NIPDAU	Level-2-260C-1 YEAR	-40 to 125	4314Q1
OPA4314AQPWRQ1.B	Active	Production	TSSOP (PW)   14	2000   LARGE T&R	Yes	NIPDAU	Level-2-260C-1 YEAR	-40 to 125	4314Q1

(1) **Status:** For more details on status, see our [product life cycle](#).

(2) **Material type:** When designated, preproduction parts are prototypes/experimental devices, and are not yet approved or released for full production. Testing and final process, including without limitation quality assurance, reliability performance testing, and/or process qualification, may not yet be complete, and this item is subject to further changes or possible discontinuation. If available for ordering, purchases will be subject to an additional waiver at checkout, and are intended for early internal evaluation purposes only. These items are sold without warranties of any kind.

(3) **RoHS values:** Yes, No, RoHS Exempt. See the [TI RoHS Statement](#) for additional information and value definition.

(4) **Lead finish/Ball material:** Parts may have multiple material finish options. Finish options are separated by a vertical ruled line. Lead finish/Ball material values may wrap to two lines if the finish value exceeds the maximum column width.

(5) **MSL rating/Peak reflow:** The moisture sensitivity level ratings and peak solder (reflow) temperatures. In the event that a part has multiple moisture sensitivity ratings, only the lowest level per JEDEC standards is shown. Refer to the shipping label for the actual reflow temperature that will be used to mount the part to the printed circuit board.

(6) **Part marking:** There may be an additional marking, which relates to the logo, the lot trace code information, or the environmental category of the part.

Multiple part markings will be inside parentheses. Only one part marking contained in parentheses and separated by a "-" will appear on a part. If a line is indented then it is a continuation of the previous line and the two combined represent the entire part marking for that device.

**Important Information and Disclaimer:**The information provided on this page represents TI's knowledge and belief as of the date that it is provided. TI bases its knowledge and belief on information provided by third parties, and makes no representation or warranty as to the accuracy of such information. Efforts are underway to better integrate information from third parties. TI has taken and continues to take reasonable steps to provide representative and accurate information but may not have conducted destructive testing or chemical analysis on incoming materials and chemicals. TI and TI suppliers consider certain information to be proprietary, and thus CAS numbers and other limited information may not be available for release.

In no event shall TI's liability arising out of such information exceed the total purchase price of the TI part(s) at issue in this document sold by TI to Customer on an annual basis.

**OTHER QUALIFIED VERSIONS OF OPA2314-Q1, OPA314-Q1, OPA4314-Q1 :**

- Catalog : [OPA2314](#), [OPA314](#), [OPA4314](#)
- Enhanced Product : [OPA2314-EP](#)

NOTE: Qualified Version Definitions:

- Catalog - TI's standard catalog product
- Enhanced Product - Supports Defense, Aerospace and Medical Applications

**TAPE AND REEL INFORMATION**

**QUADRANT ASSIGNMENTS FOR PIN 1 ORIENTATION IN TAPE**

\*All dimensions are nominal

Device	Package Type	Package Drawing	Pins	SPQ	Reel Diameter (mm)	Reel Width W1 (mm)	A0 (mm)	B0 (mm)	K0 (mm)	P1 (mm)	W (mm)	Pin1 Quadrant
OPA2314AQDRQ1	SOIC	D	8	2500	330.0	12.4	6.4	5.2	2.1	8.0	12.0	Q1
OPA314AQDBVRQ1	SOT-23	DBV	5	3000	178.0	9.0	3.3	3.2	1.4	4.0	8.0	Q3
OPA314AQDBVTQ1	SOT-23	DBV	5	250	178.0	9.0	3.23	3.17	1.37	4.0	8.0	Q3
OPA4314AQPWRQ1	TSSOP	PW	14	2000	330.0	12.4	6.9	5.6	1.6	8.0	12.0	Q1

**TAPE AND REEL BOX DIMENSIONS**

\*All dimensions are nominal

Device	Package Type	Package Drawing	Pins	SPQ	Length (mm)	Width (mm)	Height (mm)
OPA2314AQDRQ1	SOIC	D	8	2500	353.0	353.0	32.0
OPA314AQDBVRQ1	SOT-23	DBV	5	3000	180.0	180.0	18.0
OPA314AQDBVTQ1	SOT-23	DBV	5	250	180.0	180.0	18.0
OPA4314AQPWRQ1	TSSOP	PW	14	2000	353.0	353.0	32.0



D0008A

# PACKAGE OUTLINE

SOIC - 1.75 mm max height

SMALL OUTLINE INTEGRATED CIRCUIT



4214825/C 02/2019

NOTES:

- Linear dimensions are in inches [millimeters]. Dimensions in parenthesis are for reference only. Controlling dimensions are in inches. Dimensioning and tolerancing per ASME Y14.5M.
- This drawing is subject to change without notice.
- This dimension does not include mold flash, protrusions, or gate burrs. Mold flash, protrusions, or gate burrs shall not exceed .006 [0.15] per side.
- This dimension does not include interlead flash.
- Reference JEDEC registration MS-012, variation AA.



# EXAMPLE BOARD LAYOUT

D0008A

SOIC - 1.75 mm max height

SMALL OUTLINE INTEGRATED CIRCUIT



LAND PATTERN EXAMPLE  
EXPOSED METAL SHOWN  
SCALE:8X



SOLDER MASK DETAILS

4214825/C 02/2019

NOTES: (continued)

6. Publication IPC-7351 may have alternate designs.

7. Solder mask tolerances between and around signal pads can vary based on board fabrication site.

# EXAMPLE STENCIL DESIGN

D0008A

SOIC - 1.75 mm max height

SMALL OUTLINE INTEGRATED CIRCUIT



SOLDER PASTE EXAMPLE  
BASED ON .005 INCH [0.125 MM] THICK STENCIL  
SCALE:8X

4214825/C 02/2019

NOTES: (continued)

8. Laser cutting apertures with trapezoidal walls and rounded corners may offer better paste release. IPC-7525 may have alternate design recommendations.
9. Board assembly site may have different recommendations for stencil design.

PW0014A



PACKAGE OUTLINE

TSSOP - 1.2 mm max height

SMALL OUTLINE PACKAGE



NOTES:

1. All linear dimensions are in millimeters. Any dimensions in parenthesis are for reference only. Dimensioning and tolerancing per ASME Y14.5M.
2. This drawing is subject to change without notice.
3. This dimension does not include mold flash, protrusions, or gate burrs. Mold flash, protrusions, or gate burrs shall not exceed 0.15 mm per side.
4. This dimension does not include interlead flash. Interlead flash shall not exceed 0.25 mm per side.
5. Reference JEDEC registration MO-153.

# EXAMPLE BOARD LAYOUT

PW0014A

TSSOP - 1.2 mm max height

SMALL OUTLINE PACKAGE



LAND PATTERN EXAMPLE  
EXPOSED METAL SHOWN  
SCALE: 10X

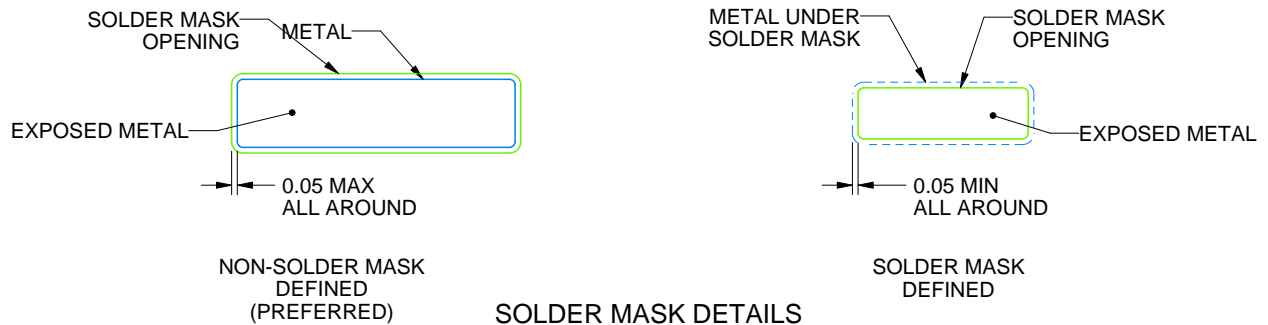

4220202/B 12/2023

NOTES: (continued)

- 6. Publication IPC-7351 may have alternate designs.
- 7. Solder mask tolerances between and around signal pads can vary based on board fabrication site.

# EXAMPLE STENCIL DESIGN

PW0014A

TSSOP - 1.2 mm max height

SMALL OUTLINE PACKAGE



SOLDER PASTE EXAMPLE  
BASED ON 0.125 mm THICK STENCIL  
SCALE: 10X

4220202/B 12/2023

NOTES: (continued)

8. Laser cutting apertures with trapezoidal walls and rounded corners may offer better paste release. IPC-7525 may have alternate design recommendations.
9. Board assembly site may have different recommendations for stencil design.



# EXAMPLE BOARD LAYOUT

DBV0005A

SOT-23 - 1.45 mm max height

SMALL OUTLINE TRANSISTOR



LAND PATTERN EXAMPLE  
EXPOSED METAL SHOWN  
SCALE:15X

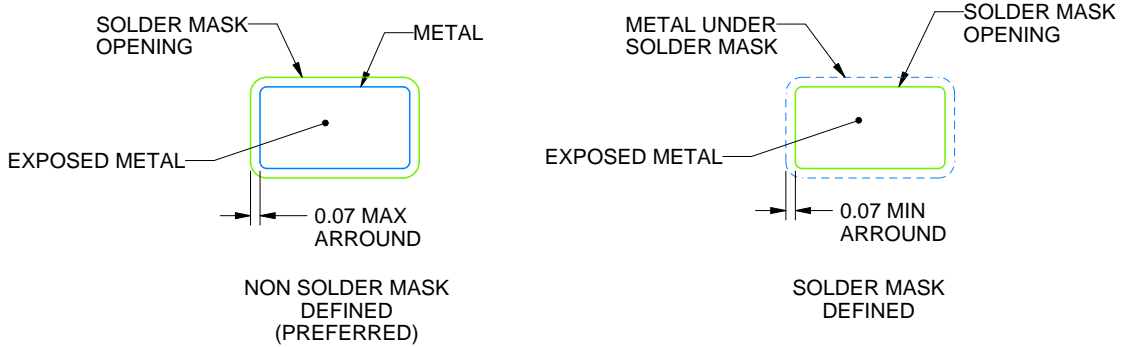

SOLDER MASK DETAILS

4214839/K 08/2024

NOTES: (continued)

- 6. Publication IPC-7351 may have alternate designs.
- 7. Solder mask tolerances between and around signal pads can vary based on board fabrication site.

# EXAMPLE STENCIL DESIGN

DBV0005A

SOT-23 - 1.45 mm max height

SMALL OUTLINE TRANSISTOR



SOLDER PASTE EXAMPLE  
BASED ON 0.125 mm THICK STENCIL  
SCALE:15X

4214839/K 08/2024

NOTES: (continued)

8. Laser cutting apertures with trapezoidal walls and rounded corners may offer better paste release. IPC-7525 may have alternate design recommendations.
9. Board assembly site may have different recommendations for stencil design.



## IMPORTANT NOTICE AND DISCLAIMER

TI PROVIDES TECHNICAL AND RELIABILITY DATA (INCLUDING DATASHEETS), DESIGN RESOURCES (INCLUDING REFERENCE DESIGNS), APPLICATION OR OTHER DESIGN ADVICE, WEB TOOLS, SAFETY INFORMATION, AND OTHER RESOURCES "AS IS" AND WITH ALL FAULTS, AND DISCLAIMS ALL WARRANTIES, EXPRESS AND IMPLIED, INCLUDING WITHOUT LIMITATION ANY IMPLIED WARRANTIES OF MERCHANTABILITY, FITNESS FOR A PARTICULAR PURPOSE OR NON-INFRINGEMENT OF THIRD PARTY INTELLECTUAL PROPERTY RIGHTS.

These resources are intended for skilled developers designing with TI products. You are solely responsible for (1) selecting the appropriate TI products for your application, (2) designing, validating and testing your application, and (3) ensuring your application meets applicable standards, and any other safety, security, regulatory or other requirements.

These resources are subject to change without notice. TI grants you permission to use these resources only for development of an application that uses the TI products described in the resource. Other reproduction and display of these resources is prohibited. No license is granted to any other TI intellectual property right or to any third party intellectual property right. TI disclaims responsibility for, and you fully indemnify TI and its representatives against any claims, damages, costs, losses, and liabilities arising out of your use of these resources.

TI's products are provided subject to [TI's Terms of Sale](#), [TI's General Quality Guidelines](#), or other applicable terms available either on [ti.com](http://ti.com) or provided in conjunction with such TI products. TI's provision of these resources does not expand or otherwise alter TI's applicable warranties or warranty disclaimers for TI products. Unless TI explicitly designates a product as custom or customer-specified, TI products are standard, catalog, general purpose devices.

TI objects to and rejects any additional or different terms you may propose.

Copyright © 2025, Texas Instruments Incorporated

Last updated 10/2025