

OPAx170-Q1 36-V, Single-Supply, Low-Power, Automotive-Grade Operational Amplifiers

1 Features

- Qualified for Automotive Applications
- AEC-Q100 Qualified With the Following Results:
 - Device Temperature Grade 1: -40°C to $+125^{\circ}\text{C}$ Ambient Operating Temperature
 - Device HBM ESD Classification Level 3A
 - Device CDM ESD Classification Level C5
- Supply Range: 2.7 V to 36 V, ± 1.35 V to ± 18 V
- Low Noise: $19\text{ nV}/\sqrt{\text{Hz}}$
- RFI Filtered Inputs
- Input Range Includes the Negative Supply
- Input Range Operates to Positive Supply
- Rail-to-Rail Output
- Gain Bandwidth: 1.2 MHz
- Low Quiescent Current: 110 μA per Amplifier
- High Common-Mode Rejection: 120 dB
- Low Bias Current: 15 pA (Maximum)
- Number of Channels:
 - OPA170-Q1: 1
 - OPA2170-Q1: 2
 - OPA4170-Q1: 4
- Industry-Standard Packages

2 Applications

- Automotive
- HEV and EV Power Trains
- Advanced Driver Assist (ADAS)
- Automatic Climate Controls
- Temperature Measurements
- Strain Gauge Amplifiers
- Precision Integrators

3 Description

The OPA170-Q1, OPA2170-Q1, and OPA4170-Q1 devices (OPAx170-Q1) are a family of 36-V, single-supply, low-noise operational amplifiers that feature micro packages with the ability to operate on supplies ranging from 2.7 V (± 1.35 V) to 36 V (± 18 V). They offer good offset, drift, and bandwidth with low quiescent current.

Unlike most operational amplifiers, which are specified at only one supply voltage, the OPAx170-Q1 family of operational amplifiers is specified from 2.7 V to 36 V. Input signals beyond the supply rails do not cause phase reversal. The OPAx170-Q1 family is stable with capacitive loads up to 300 pF. The input can operate 100 mV below the negative rail and within 2 V of the positive rail for normal operation. Note that these devices can operate with full rail-to-rail input 100 mV beyond the positive rail, but with reduced performance within 2 V of the positive rail. The OPAx170-Q1 operational amplifiers are specified from -40°C to $+125^{\circ}\text{C}$.

Device Information⁽¹⁾

PART NUMBER	PACKAGE	BODY SIZE (NOM)
OPA170-Q1	SOT-23 (5)	2.90 mm x 1.60 mm
OPA2170-Q1	VSSOP (8)	3.00 mm x 3.00 mm
OPA4170-Q1	TSSOP (14)	5.00 mm x 4.40 mm

(1) For all available packages, see the orderable addendum at the end of the data sheet.

EMIRR IN+ vs Frequency

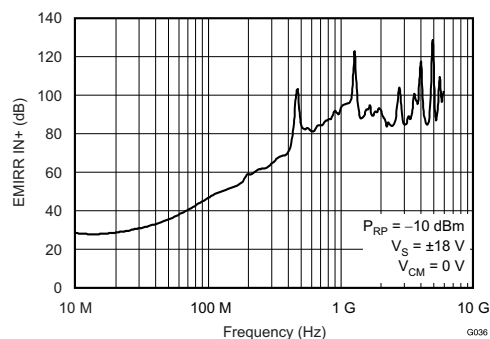

Table of Contents

1 Features	1	7.3 Feature Description.....	17
2 Applications	1	7.4 Device Functional Modes.....	21
3 Description	1	8 Application and Implementation	22
4 Revision History	2	8.1 Application Information.....	22
5 Pin Configuration and Functions	3	8.2 Typical Application	22
6 Specifications	6	9 Power Supply Recommendations	24
6.1 Absolute Maximum Ratings	6	10 Layout	24
6.2 ESD Ratings	6	10.1 Layout Guidelines	24
6.3 Recommended Operating Conditions.....	6	10.2 Layout Example	25
6.4 Thermal Information: OPA170-Q1	7	11 Device and Documentation Support	26
6.5 Thermal Information: OPA2170-Q1	7	11.1 Device Support.....	26
6.6 Thermal Information: OPA4170-Q1	7	11.2 Documentation Support	27
6.7 Electrical Characteristics.....	8	11.3 Related Links	27
6.8 Typical Characteristics: Table of Graphs.....	10	11.4 Community Resources.....	27
6.9 Typical Characteristics.....	11	11.5 Trademarks	27
7 Detailed Description	17	11.6 Electrostatic Discharge Caution.....	27
7.1 Overview	17	11.7 Glossary	27
7.2 Functional Block Diagram	17	12 Mechanical, Packaging, and Orderable Information	28

4 Revision History

Changes from Revision A (March 2017) to Revision B

Page

• Deleted 8-pin SOIC, 5-pin SOT, 8-pin VSSOP, and 14-pin SOIC packages from <i>Device Information</i> table.....	1
• Changed front-page graphic	1
• Deleted OPA170-Q1 D (SOIC) and DRL (SOT) pinout drawings and pinout table information.....	3
• Deleted OPA2170-Q1 D (SOIC) and DCU (VSSOP <i>Micro</i> size packages	4
• Deleted OPA170-Q1 D (SOIC) pinout drawing	5
• Deleted D (SOIC) and DRL (SOT) thermal information from OPA170-Q1 <i>Thermal Information</i> table	7
• Deleted D (SOIC) and DCU (VSSOP) thermal information from OPA2170-Q1 <i>Thermal Information</i> table	7
• Deleted D (SOIC) thermal information from OPA4170-Q1 <i>Thermal Information</i> table	7
• Changed values in Figure 38 from 250 Ω to 2.5 kΩ	19

Changes from Original (December 2016) to Revision A

Page

• Deleted last sentence of first para of <i>Description</i>	1
• Deleted static literature number in <i>Thermal Information: OPA170-Q1</i> table note	7
• Separated the IB and IOS test conditions for the OPA4170 in <i>Electrical Characteristics</i> table.....	8
• Added additional text to Figure 8 title	12
• Changed "many specifications apply from –40°C to +125°C" to "many specifications apply from –40°C to +85°C" to correct typo.....	24

5 Pin Configuration and Functions

**OPA170-Q1 DBV Package
5-Pin SOT-23
Top View**

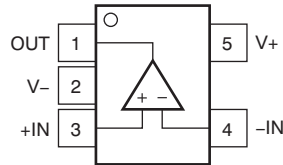

Table 1. Pin Functions: OPA170-Q1

PIN		I/O	DESCRIPTION
NAME	NO.		
IN- (-IN)	4	I	Negative (inverting) input
IN+ (+IN)	3	I	Positive (noninverting) input
OUT	1	O	Output
V-	2	—	Negative (lowest) power supply
V+	5	—	Positive (highest) power supply

**OPA2170-Q1 DGK Package
8-Pin VSSOP
Top View**

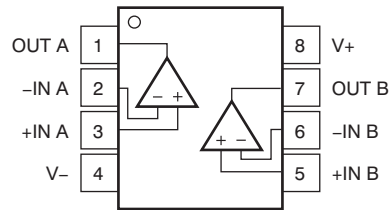

Table 2. Pin Functions: OPA2170-Q1

PIN		I/O	DESCRIPTION
NAME	NO.		
-IN A	2	I	Inverting input, channel A
-IN B	6	I	Inverting input, channel B
+IN A	3	I	Noninverting input, channel A
+IN B	5	I	Noninverting input, channel B
OUT A	1	O	Output, channel A
OUT B	7	O	Output, channel B
V-	4	—	Negative (lowest) power supply
V+	8	—	Positive (highest) power supply

**OPA4170-Q1 PW Package
14-Pin TSSOP
Top View**

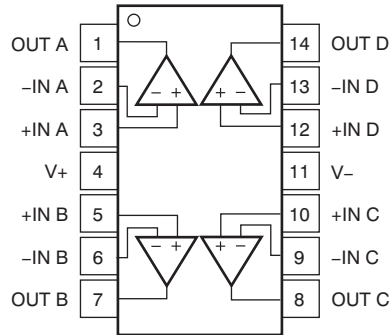

Table 3. Pin Functions: OPA4170-Q1

PIN		I/O	DESCRIPTION
NAME	NO.		
-IN A	2	I	Inverting input, channel A
-IN B	6	I	Inverting input, channel B
-IN C	9	I	Inverting input, channel C
-IN D	13	I	Inverting input, channel D
+IN A	3	I	Noninverting input, channel A
+IN B	5	I	Noninverting input, channel B
+IN C	10	I	Noninverting input, channel C
+IN D	12	I	Noninverting input, channel D
OUT A	1	O	Output, channel A
OUT B	7	O	Output, channel B
OUT C	8	O	Output, channel C
OUT D	14	O	Output, channel D
V-	11	—	Negative (lowest) power supply
V+	4	—	Positive (highest) power supply

6 Specifications

6.1 Absolute Maximum Ratings

over operating free-air temperature range (unless otherwise noted)⁽¹⁾

	MIN	MAX	UNIT
Supply voltage	-20	20	V
Single supply voltage		40	V
Signal input pin voltage	(V-) - 0.5	(V+) + 0.5	V
Signal input pin current	-10	10	mA
Output short-circuit current ⁽²⁾	Continuous		
Operating ambient temperature, T _A	-55	150	°C
Junction temperature, T _J		150	°C
Storage temperature, T _{stg}	-65	150	°C

(1) Stresses beyond those listed under *Absolute Maximum Ratings* may cause permanent damage to the device. These are stress ratings only, which do not imply functional operation of the device at these or any other conditions beyond those indicated under *Recommended Operating Conditions*. Exposure to absolute-maximum-rated conditions for extended periods may affect device reliability.

(2) Short-circuit to ground, one amplifier per package.

6.2 ESD Ratings

		VALUE	UNIT
V _(ESD)	Electrostatic discharge	Human-body model (HBM), per AEC Q100-002 ⁽¹⁾	V
		Charged-device model (CDM), per AEC Q100-011	

(1) AEC Q100-002 indicates that HBM stressing shall be in accordance with the ANSI/ESDA/JEDEC JS-001 specification.

6.3 Recommended Operating Conditions

over operating free-air temperature range (unless otherwise noted)

		MIN	MAX	UNIT
V _S	Supply voltage (V+ - V-)	2.7	36	V
T _A	Operating temperature	-40	125	°C

6.4 Thermal Information: OPA170-Q1

THERMAL METRIC ⁽¹⁾		OPA170-Q1	
		DBV (SOT-23)	
		5 PINS	
Symbol	Description	Value	UNIT
$R_{\theta JA}$	Junction-to-ambient thermal resistance	245.8	°C/W
$R_{\theta JC(top)}$	Junction-to-case (top) thermal resistance	133.9	°C/W
$R_{\theta JB}$	Junction-to-board thermal resistance	83.6	°C/W
Ψ_{JT}	Junction-to-top characterization parameter	18.2	°C/W
Ψ_{JB}	Junction-to-board characterization parameter	83.1	°C/W
$R_{\theta JC(bot)}$	Junction-to-case (bottom) thermal resistance	—	°C/W

- (1) For more information about traditional and new thermal metrics, see the [Semiconductor and IC Package Thermal Metrics](#) application report.

6.5 Thermal Information: OPA2170-Q1

THERMAL METRIC ⁽¹⁾		OPA2170-Q1	
		DGK (VSSOP)	
		8 PINS	
Symbol	Description	Value	UNIT
$R_{\theta JA}$	Junction-to-ambient thermal resistance	180	°C/W
$R_{\theta JC(top)}$	Junction-to-case (top) thermal resistance	55	°C/W
$R_{\theta JB}$	Junction-to-board thermal resistance	130	°C/W
Ψ_{JT}	Junction-to-top characterization parameter	5.3	°C/W
Ψ_{JB}	Junction-to-board characterization parameter	120	°C/W
$R_{\theta JC(bot)}$	Junction-to-case (bottom) thermal resistance	—	°C/W

- (1) For more information about traditional and new thermal metrics, see the [Semiconductor and IC Package Thermal Metrics](#) application report.

6.6 Thermal Information: OPA4170-Q1

THERMAL METRIC ⁽¹⁾		OPA4170-Q1	
		PW (TSSOP)	
		14 PINS	
Symbol	Description	Value	UNIT
$R_{\theta JA}$	Junction-to-ambient thermal resistance	106.9	°C/W
$R_{\theta JC(top)}$	Junction-to-case (top) thermal resistance	24.4	°C/W
$R_{\theta JB}$	Junction-to-board thermal resistance	59.3	°C/W
Ψ_{JT}	Junction-to-top characterization parameter	0.6	°C/W
Ψ_{JB}	Junction-to-board characterization parameter	54.3	°C/W
$R_{\theta JC(bot)}$	Junction-to-case (bottom) thermal resistance	—	°C/W

- (1) For more information about traditional and new thermal metrics, see the [Semiconductor and IC Package Thermal Metrics](#) application report.

6.7 Electrical Characteristics

 at $T_A = 25^\circ\text{C}$, $V_{CM} = V_{OUT} = V_S / 2$, and $R_L = 10\text{ k}\Omega$ connected to $V_S / 2$ (unless otherwise noted)

PARAMETER		TEST CONDITIONS	MIN	TYP	MAX	UNIT
OFFSET VOLTAGE						
V_{OS}	Input offset voltage	$T_A = 25^\circ\text{C}$		0.25	± 1.8	mV
		$T_A = -40^\circ\text{C}$ to 125°C			± 2	mV
dV_{OS}/dT	Input offset voltage drift	$T_A = -40^\circ\text{C}$ to 125°C		± 0.3	± 2	$\mu\text{V}/^\circ\text{C}$
PSRR	Input offset voltage vs power supply	$V_S = 4\text{ V}$ to 36 V $T_A = -40^\circ\text{C}$ to 125°C		1	± 5	$\mu\text{V}/\text{V}$
	Channel separation, dc			5		$\mu\text{V}/\text{V}$
INPUT BIAS CURRENT						
I_B	Input bias current	$T_A = 25^\circ\text{C}$		± 8	± 15	pA
		$T_A = -40^\circ\text{C}$ to 125°C (OPA170-Q1 and OPA2170-Q1)			± 3.5	nA
		$T_A = -40^\circ\text{C}$ to 125°C (OPA4170-Q1)			± 16	
I_{OS}	Input offset current	$T_A = 25^\circ\text{C}$		± 4	± 15	pA
		$T_A = -40^\circ\text{C}$ to 125°C (OPA170-Q1 and OPA2170-Q1)			± 3.5	nA
		$T_A = -40^\circ\text{C}$ to 125°C (OPA4170-Q1)			± 16	
NOISE						
	Input voltage noise	$f = 0.1\text{ Hz}$ to 10 Hz		2		μV_{PP}
e_n	Input voltage noise density	$f = 100\text{ Hz}$		22		$\text{nV}/\sqrt{\text{Hz}}$
		$f = 1\text{ kHz}$		19		$\text{nV}/\sqrt{\text{Hz}}$
INPUT VOLTAGE						
V_{CM}	Common-mode voltage range ⁽¹⁾		$(V-) - 0.1$		$(V+) - 2$	V
CMRR	Common-mode rejection ratio	$V_S = \pm 2\text{ V}$, $(V-) - 0.1\text{ V} < V_{CM} < (V+) - 2\text{ V}$ $T_A = -40^\circ\text{C}$ to 125°C	90	104		dB
		$V_S = \pm 18\text{ V}$, $(V-) - 0.1\text{ V} < V_{CM} < (V+) - 2\text{ V}$ $T_A = -40^\circ\text{C}$ to 125°C	104	120		dB
INPUT IMPEDANCE						
	Differential			$100 \parallel 3$		$\text{M}\Omega \parallel \text{pF}$
	Common-mode			$6 \parallel 3$		$10^{12}\ \Omega \parallel \text{pF}$
OPEN-LOOP GAIN						
A_{OL}	Open-loop voltage gain	$V_S = 4\text{ V}$ to 36 V $(V-) + 0.35\text{ V} < V_O < (V+) - 0.35\text{ V}$ $T_A = -40^\circ\text{C}$ to 125°C	110	130		dB
FREQUENCY RESPONSE						
GBP	Gain bandwidth product			1.2		MHz
SR	Slew rate	$G = 1$		0.4		$\text{V}/\mu\text{s}$
t_S	Settling time	To 0.1%, $V_S = \pm 18\text{ V}$, $G = 1$ 10-V step		20		μs
		To 0.01% (12-bit), $V_S = \pm 18\text{ V}$, $G = 1$ 10-V step		28		μs
	Overload recovery time	$V_{IN} \times \text{Gain} > V_S$		2		μs
THD+N	Total harmonic distortion + noise	$G = 1$, $f = 1\text{ kHz}$, $V_O = 3\text{ V}_{RMS}$		0.0002%		

(1) The input range can be extended beyond $(V+) - 2\text{ V}$ up to $V+$. For additional information, see [Typical Characteristics](#) and [Application and Implementation](#).

Electrical Characteristics (continued)

 at $T_A = 25^\circ\text{C}$, $V_{CM} = V_{OUT} = V_S / 2$, and $R_L = 10\text{ k}\Omega$ connected to $V_S / 2$ (unless otherwise noted)

PARAMETER		TEST CONDITIONS	MIN	TYP	MAX	UNIT
OUTPUT						
V_O	Voltage output swing from positive rail	$I_L = 0\text{ mA}$ $V_S = 4\text{ V to }36\text{ V}$	10			mV
		I_L sourcing 1 mA $V_S = 4\text{ V to }36\text{ V}$	115			mV
V_O	Voltage output swing from negative rail	$I_L = 0\text{ mA}$ $V_S = 4\text{ V to }36\text{ V}$			8	mV
		I_L sinking 1 mA $V_S = 4\text{ V to }36\text{ V}$			70	mV
V_O	Voltage output swing from rail	$V_S = 5\text{ V}$ $R_L = 10\text{ k}\Omega$ $T_A = -40^\circ\text{C to }125^\circ\text{C}$	$(V-) + 0.03$		$(V+) - 0.05$	V
		$R_L = 10\text{ k}\Omega$ $A_{OL} \geq 110\text{ dB}$ $T_A = -40^\circ\text{C to }125^\circ\text{C}$	$(V-) + 0.35$		$(V+) - 0.35$	V
I_{SC}	Short-circuit current		-20		17	mA
C_{LOAD}	Capacitive load drive		See Typical Characteristics			pF
R_O	Open-loop output resistance	$f = 1\text{ MHz}$ $I_O = 0\text{ A}$		900		Ω
POWER SUPPLY						
V_S	Specified voltage range		2.7		36	V
I_Q	Quiescent current per amplifier	$I_O = 0\text{ A}$ $T_A = 25^\circ\text{C}$		110	145	μA
		$I_O = 0\text{ A}$ $T_A = -40^\circ\text{C to }125^\circ\text{C}$			155	μA
TEMPERATURE						
	Specified range		-40		125	$^\circ\text{C}$
	Operating range		-55		150	$^\circ\text{C}$

6.8 Typical Characteristics: Table of Graphs

Table 4. Characteristic Performance Measurements

DESCRIPTION	FIGURE
Offset Voltage Production Distribution	Figure 1
Offset Voltage Drift Distribution	Figure 2
Offset Voltage vs Temperature	Figure 3
Offset Voltage vs Common-Mode Voltage	Figure 4
Offset Voltage vs Common-Mode Voltage (Upper Stage)	Figure 5
Offset Voltage vs Power Supply	Figure 6
I_B and I_{OS} vs Common-Mode Voltage	Figure 7
Input Bias Current vs Temperature	Figure 8
Output Voltage Swing vs Output Current (Maximum Supply)	Figure 9
CMRR and PSRR vs Frequency (Referred-to-Input)	Figure 10
CMRR vs Temperature	Figure 11
PSRR vs Temperature	Figure 12
0.1-Hz to 10-Hz Noise	Figure 13
Input Voltage Noise Spectral Density vs Frequency	Figure 14
THD+N Ratio vs Frequency	Figure 15
THD+N vs Output Amplitude	Figure 16
Quiescent Current vs Temperature	Figure 17
Quiescent Current vs Supply Voltage	Figure 18
Open-Loop Gain and Phase vs Frequency	Figure 19
Closed-Loop Gain vs Frequency	Figure 20
Open-Loop Gain vs Temperature	Figure 21
Open-Loop Output Impedance vs Frequency	Figure 22
Small-Signal Overshoot vs Capacitive Load (100-mV Output Step)	Figure 23 , Figure 24
No Phase Reversal	Figure 25
Positive Overload Recovery	Figure 26
Negative Overload Recovery	Figure 27
Small-Signal Step Response (100 mV)	Figure 28 , Figure 29
Large-Signal Step Response	Figure 30 , Figure 31
Large-Signal Settling Time (10-V Positive Step)	Figure 32
Large-Signal Settling Time (10-V Negative Step)	Figure 33
Short-Circuit Current vs Temperature	Figure 34
Maximum Output Voltage vs Frequency	Figure 35
EMIRR IN+ vs Frequency	Figure 36

6.9 Typical Characteristics

$V_S = \pm 18\text{ V}$, $V_{CM} = V_S / 2$, $R_{LOAD} = 10\text{ k}\Omega$ connected to $V_S / 2$, and $C_L = 100\text{ pF}$ (unless otherwise noted)

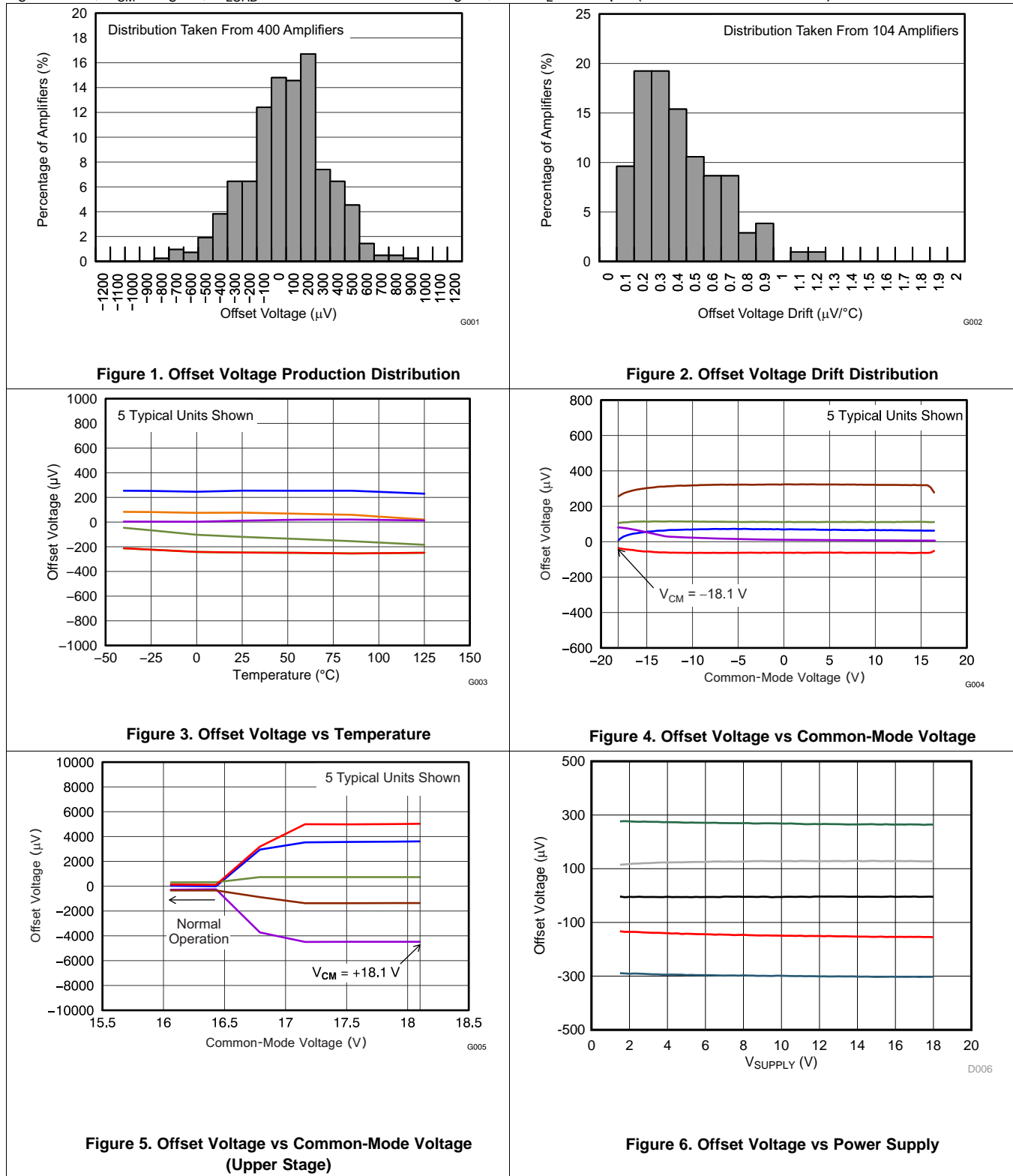

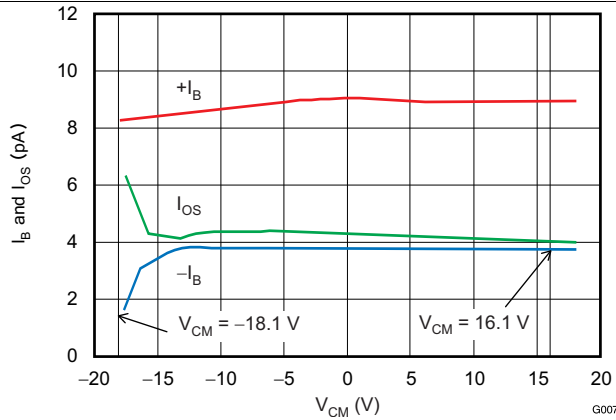

Figure 7. I_B and I_{OS} vs Common-Mode Voltage

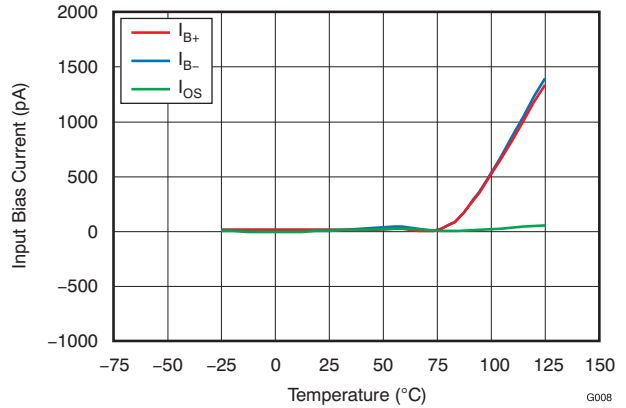

Figure 8. Input Bias Current vs Temperature for Single and Dual Versions

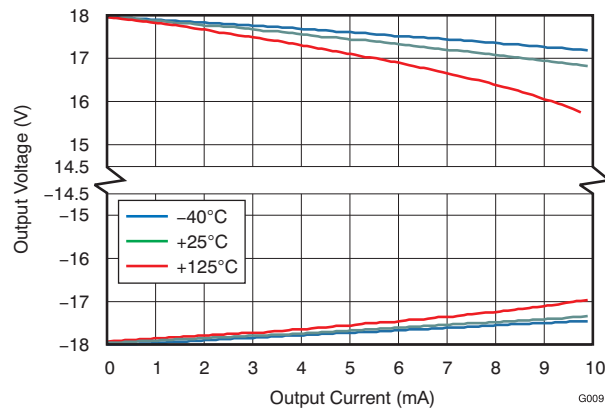

Figure 9. Output Voltage Swing vs Output Current (Maximum Supply)

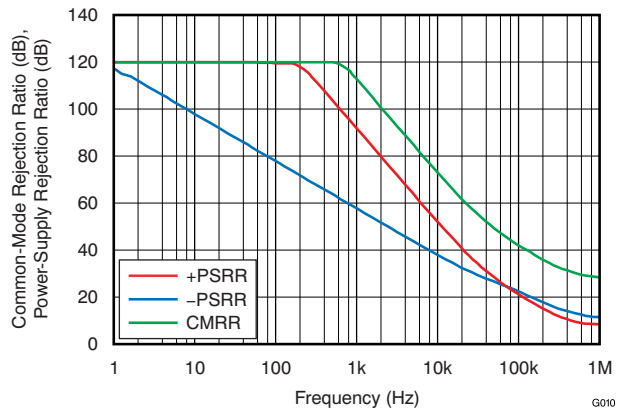

Figure 10. CMRR and PSRR vs Frequency (Referred to Input)

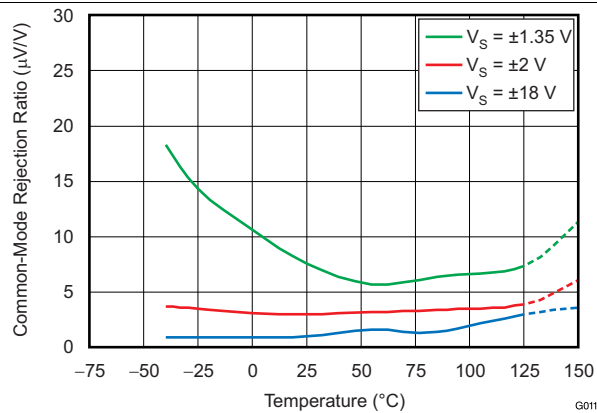

Figure 11. CMRR vs Temperature

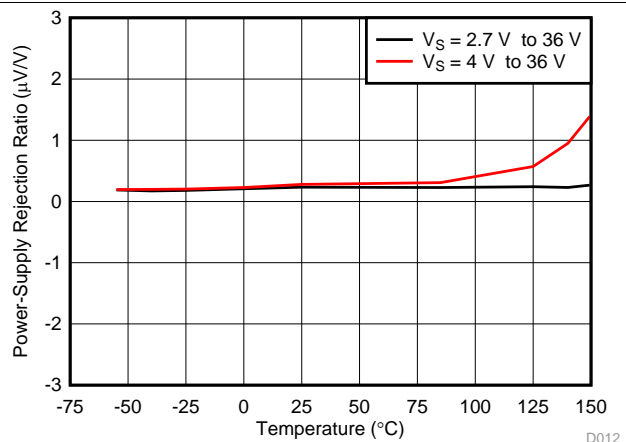
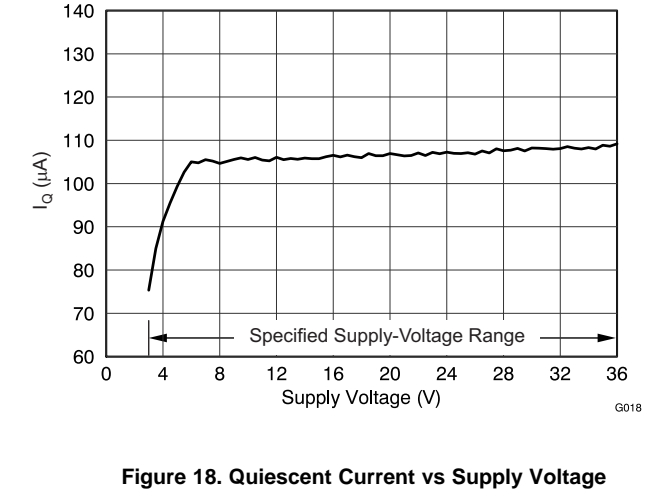
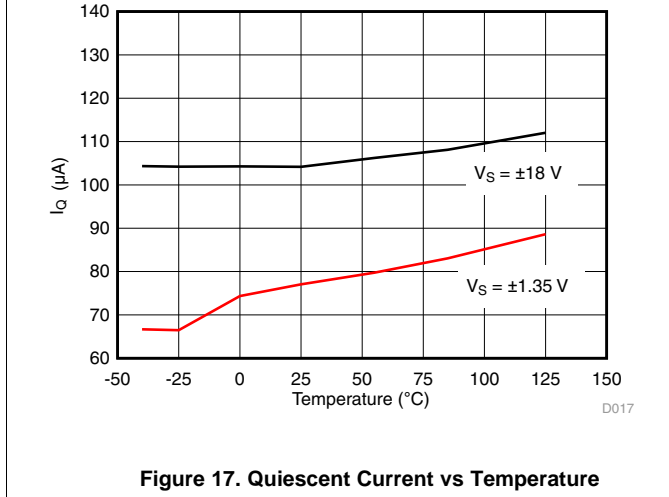
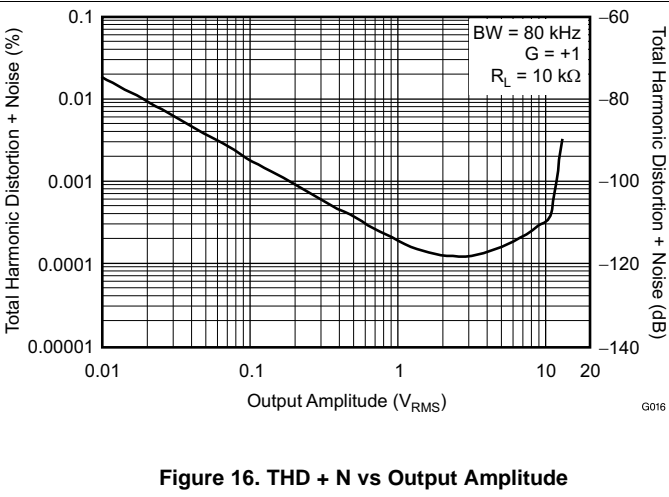
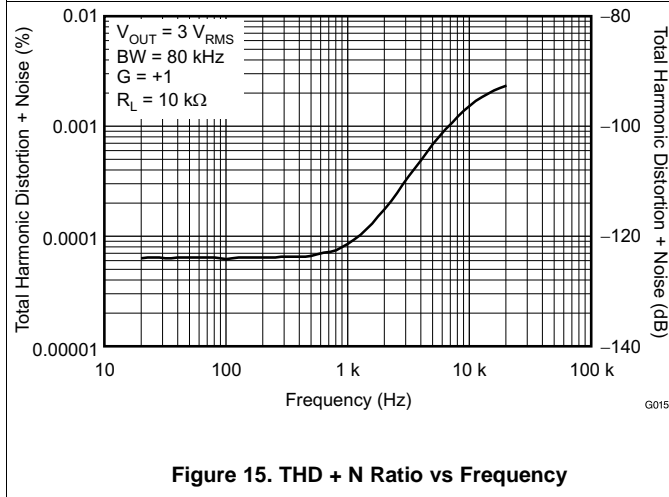
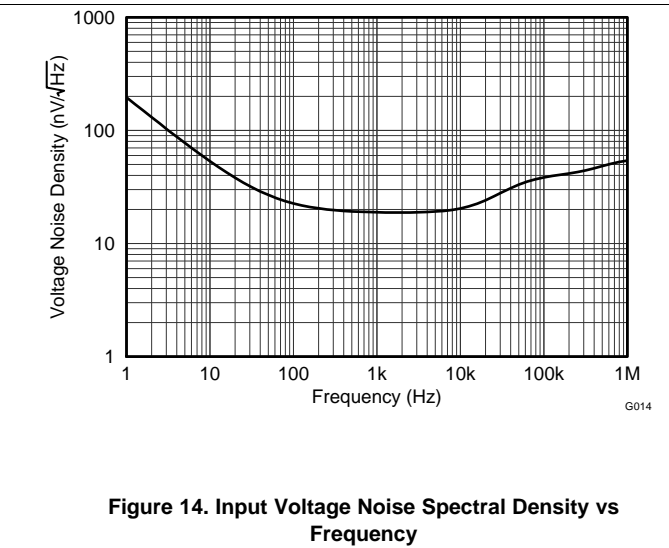
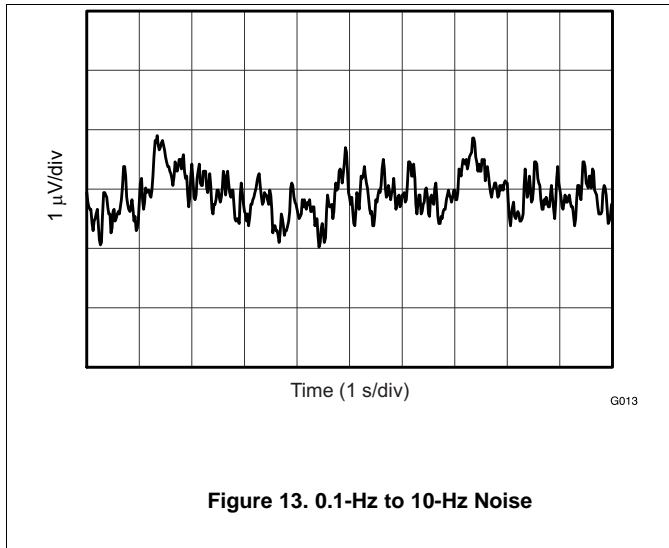

Figure 12. PSRR vs Temperature



OPA170-Q1, OPA2170-Q1, OPA4170-Q1

SBOS834B – DECEMBER 2016 – REVISED NOVEMBER 2017

www.ti.com

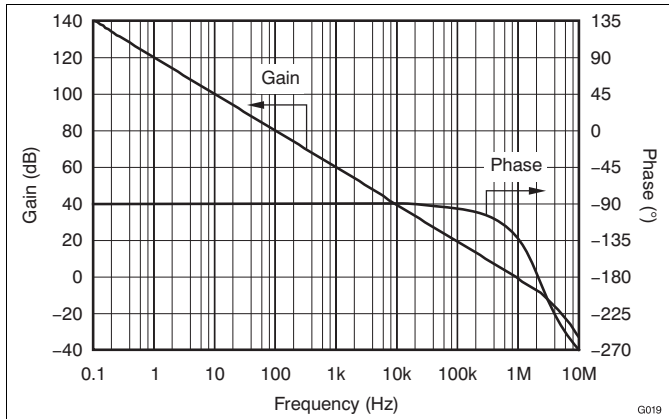

Figure 19. Open-Loop Gain and Phase vs Frequency

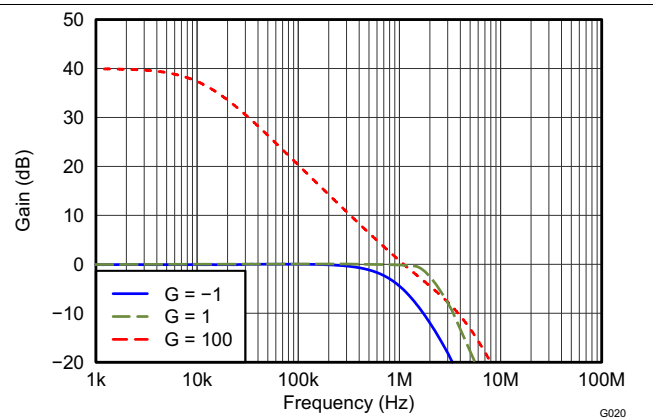

Figure 20. Closed-Loop Gain vs Frequency

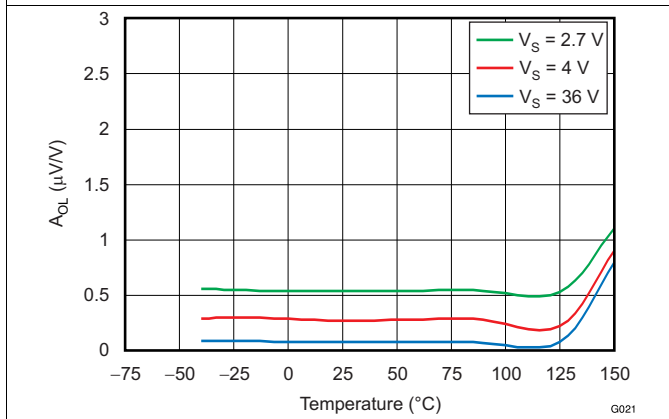

Figure 21. Open-Loop Gain vs Temperature

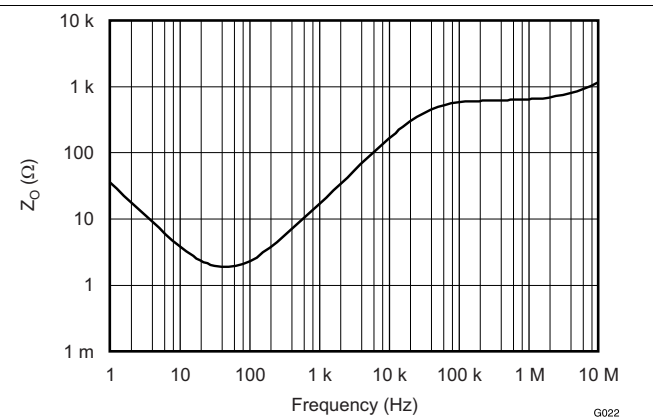

Figure 22. Open-Loop Output Impedance vs Frequency

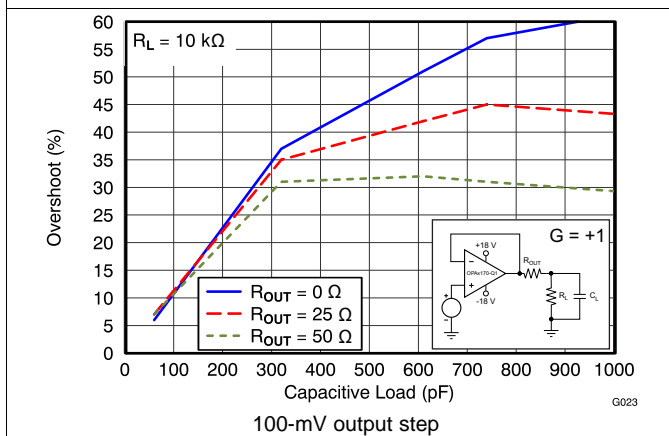

Figure 23. Small-Signal Overshoot vs Capacitive Load

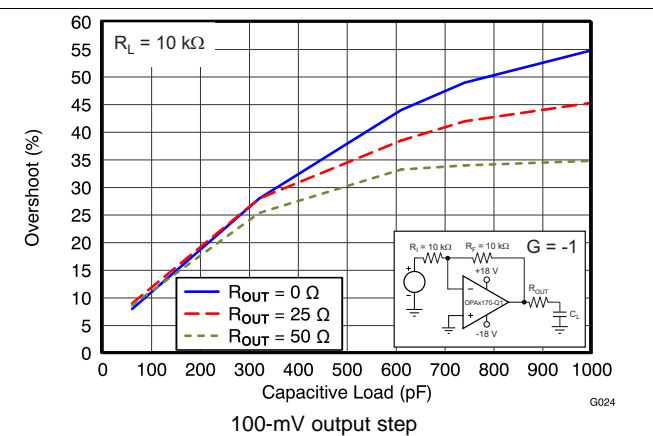

Figure 24. Small-Signal Overshoot vs Capacitive Load

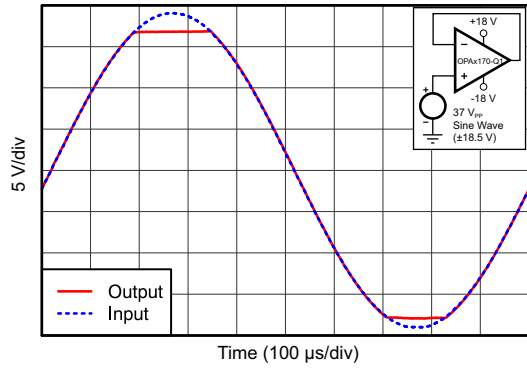

Figure 25. No Phase Reversal

G025

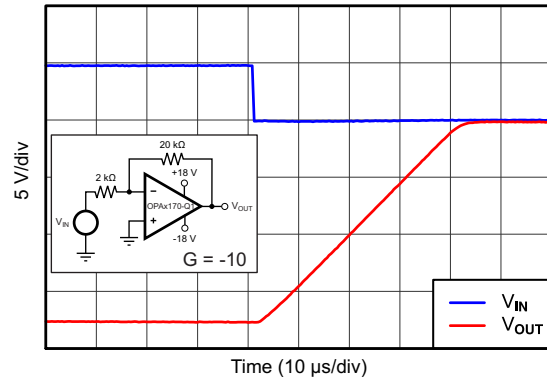

Figure 26. Positive Overload Recovery

G026

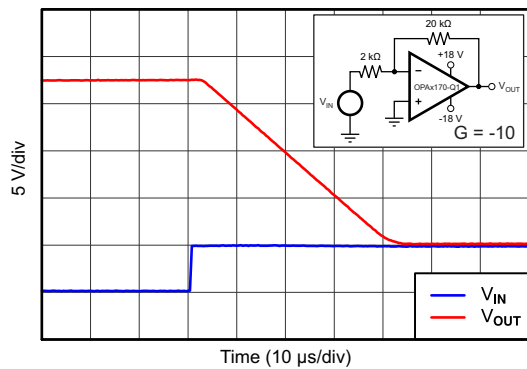

Figure 27. Negative Overload Recovery

G027

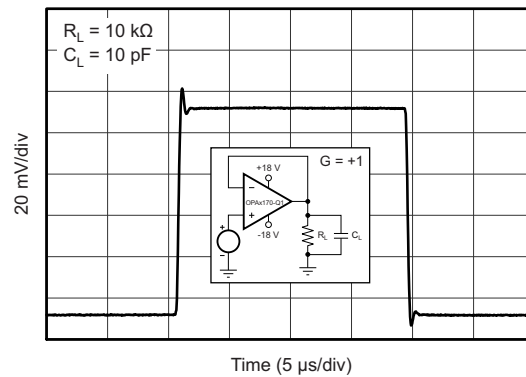

Figure 28. Small-Signal Step Response (100-mV)

G028

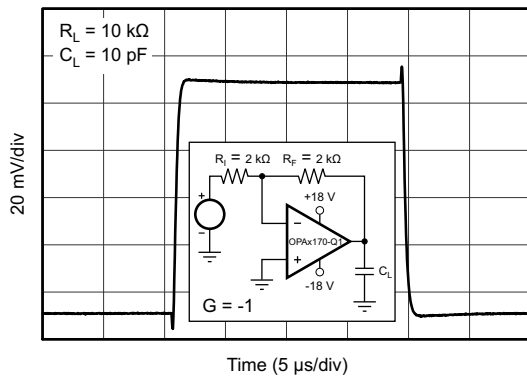

Figure 29. Small-Signal Step Response (100-mV)

G029

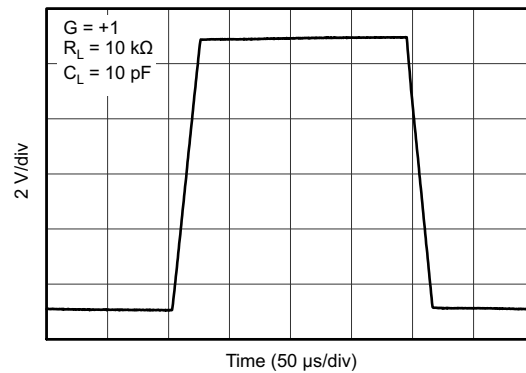

Figure 30. Large-Signal Step Response

G030

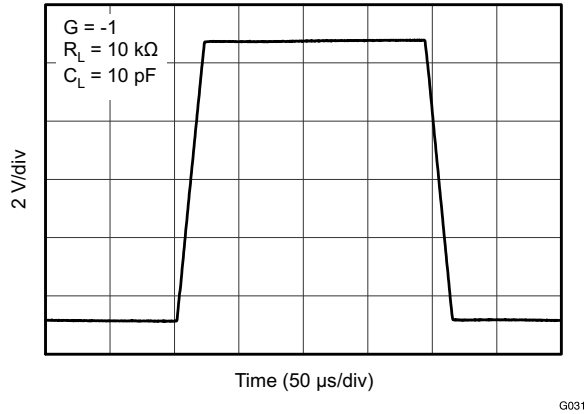

Figure 31. Large-Signal Step Response

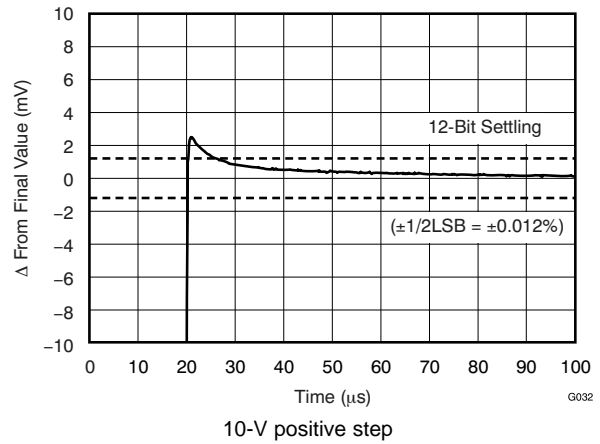

Figure 32. Large-Signal Settling Time

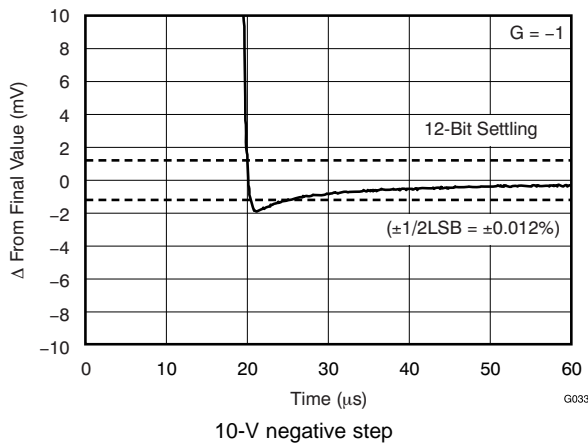

Figure 33. Large-Signal Settling Time

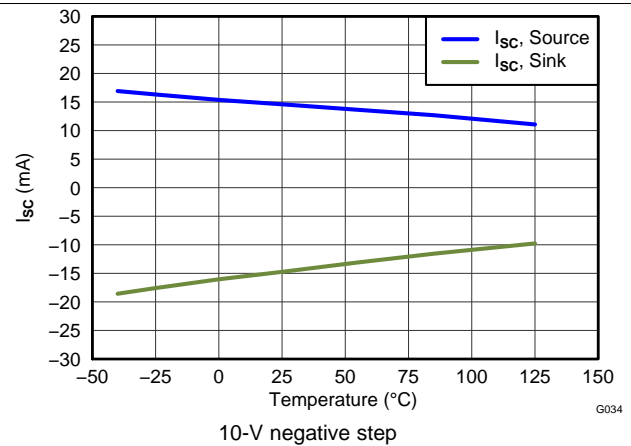

Figure 34. Short-Circuit Current vs Temperature

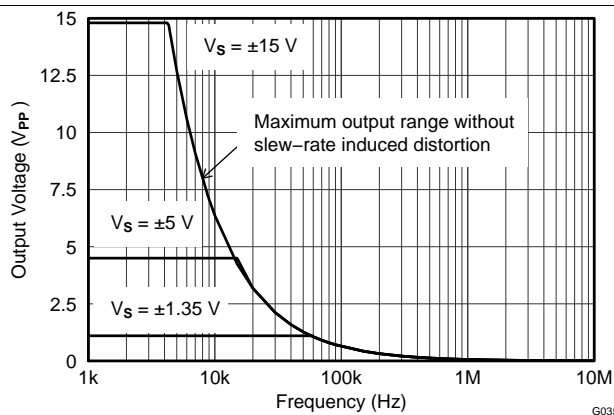

Figure 35. Maximum Output Voltage vs Frequency

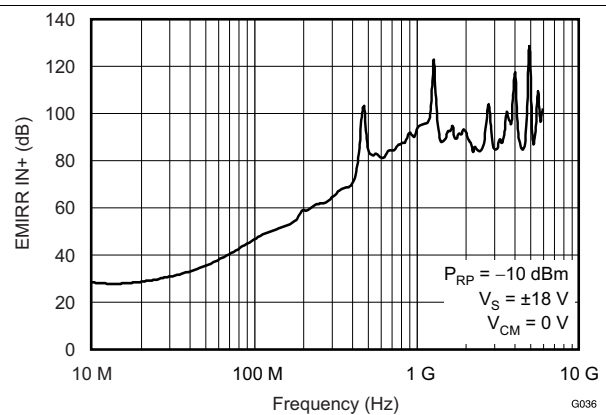

Figure 36. EMIRR IN+ vs Frequency

7 Detailed Description

7.1 Overview

The OPAx170-Q1 family of operational amplifiers provides high overall performance, making them ideal for many general-purpose applications. The excellent offset drift of only $2 \mu\text{V}/^\circ\text{C}$ provides excellent stability over the entire temperature range. In addition, the device offers very good overall performance with high CMRR, PSRR, and A_{OL} .

7.2 Functional Block Diagram

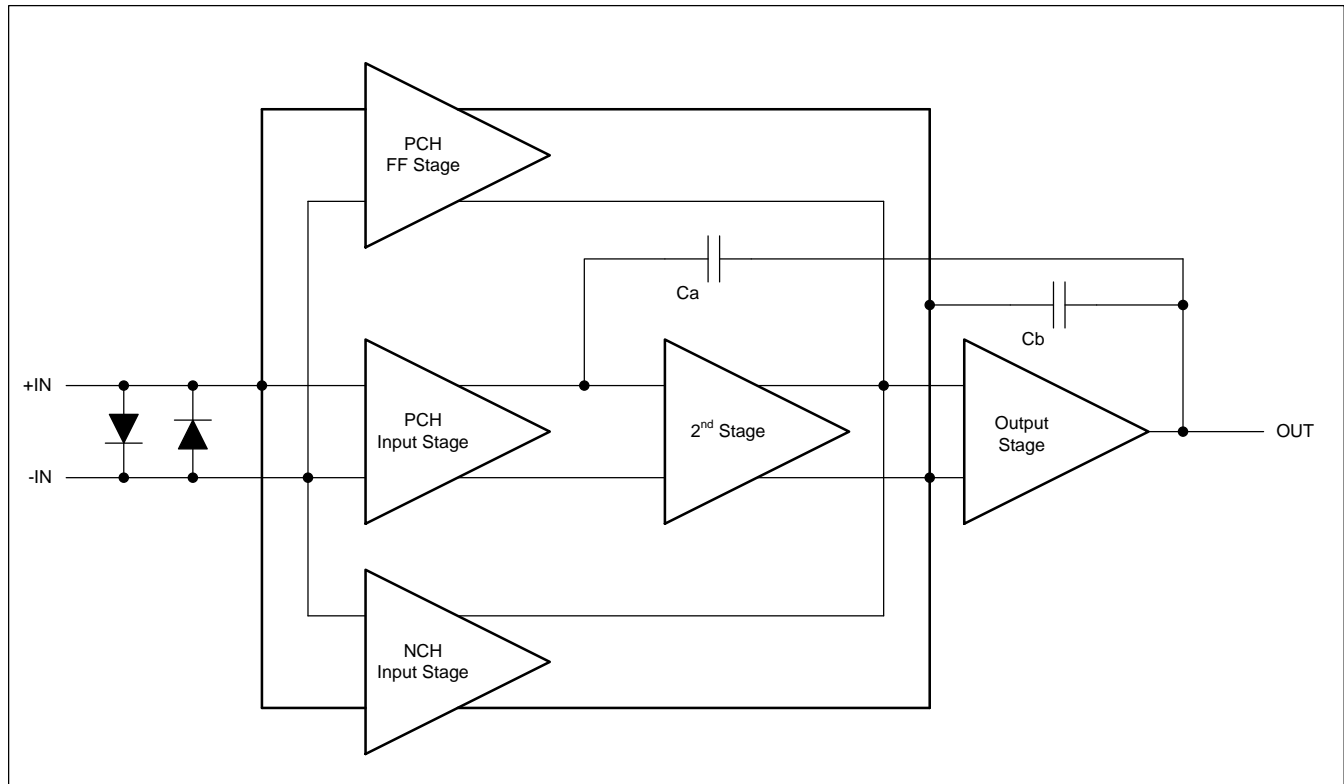

Copyright © 2017, Texas Instruments Incorporated

7.3 Feature Description

7.3.1 Operating Characteristics

The OPAx170-Q1 family of amplifiers is specified for operation from 2.7 V to 36 V ($\pm 1.35 \text{ V}$ to $\pm 18 \text{ V}$). Many of the specifications apply from -40°C to $+125^\circ\text{C}$. Parameters that can exhibit significant variance with regard to operating voltage or temperature are listed in [Table 4](#).

Feature Description (continued)

7.3.2 Phase-Reversal Protection

The OPAx170-Q1 family has an internal phase-reversal protection. Many operational amplifiers exhibit a phase reversal when the input is driven beyond the linear common-mode range. This condition is most often encountered in noninverting circuits when the input is driven beyond the specified common-mode voltage range, causing the output to reverse into the opposite rail. The input of the OPAx170-Q1 prevents phase reversal with excessive common-mode voltage. Instead, the output limits into the appropriate rail. [Figure 37](#) shows this performance.

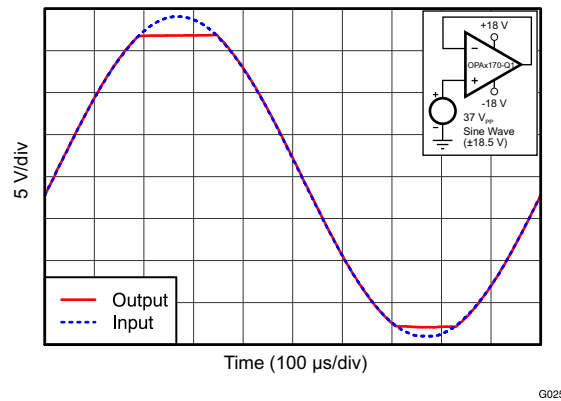

Figure 37. No Phase Reversal

7.3.3 Electrical Overstress

Designers typically ask questions about the capability of an operational amplifier to withstand electrical overstress. These questions typically focus on the device inputs, but may involve the supply voltage pins or the output pin. Each of these different pin functions have electrical stress limits determined by the voltage breakdown characteristics of the particular semiconductor fabrication process and specific circuits connected to the pin. Internal electrostatic discharge (ESD) protection is built into these circuits to protect them from accidental ESD events both before and during product assembly.

A good understanding of basic ESD circuitry and the relevance of the circuitry to an electrical overstress event is helpful. [Figure 38](#) shows the ESD circuits (indicated by the dashed line area) in the OPAx170-Q1. The ESD protection circuitry involves several current-steering diodes connected from the input and output pins and routed back to the internal power-supply lines, where the diodes meet at an absorption device internal to the operational amplifier. This protection circuitry is intended to remain inactive during normal circuit operation.

Feature Description (continued)

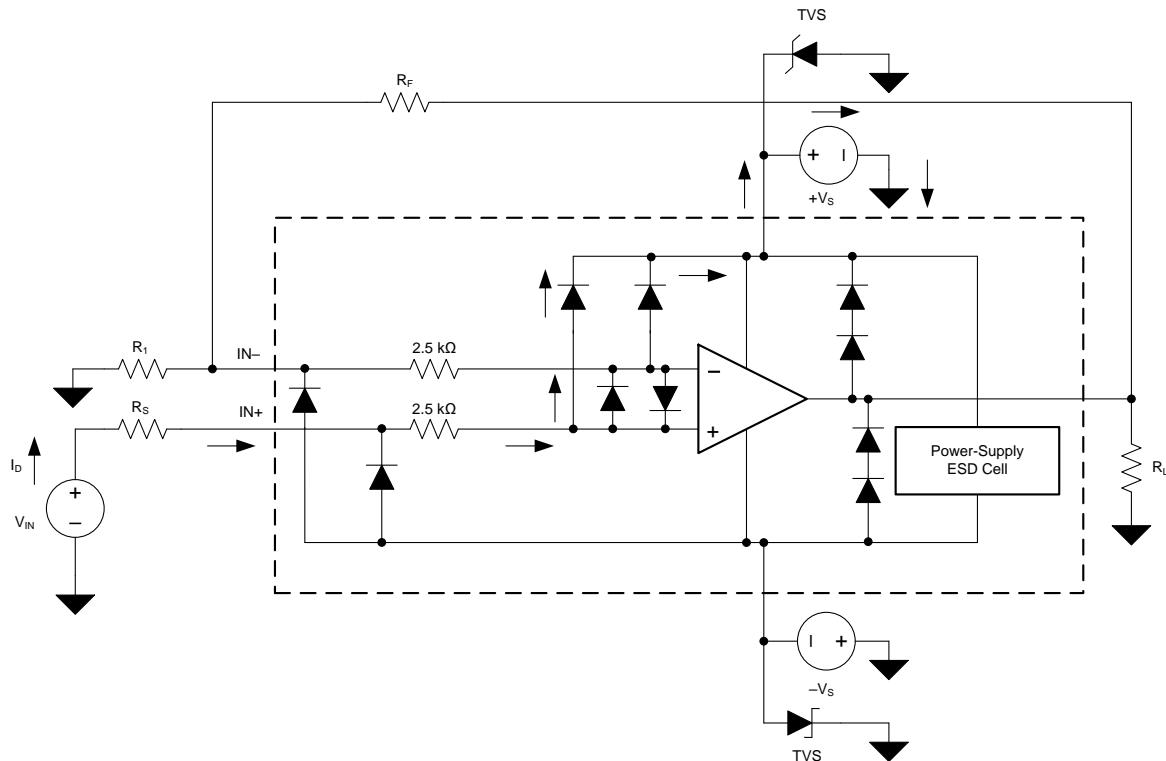

Figure 38. Equivalent Internal ESD Circuitry Relative to a Typical Circuit Application

An ESD event produces a short-duration, high-voltage pulse that is transformed into a short-duration, high-current pulse when discharging through a semiconductor device. The ESD protection circuits are designed to provide a current path around the operational amplifier core to prevent damage. The energy absorbed by the protection circuitry is then dissipated as heat.

When an ESD voltage develops across two or more amplifier device pins, current flows through one or more steering diodes. The absorption device can activate depending on the path of the current. The absorption device has a trigger (or threshold voltage) that is above the normal operating voltage of the OPAx170-Q1, but below the device breakdown voltage level. When this threshold is exceeded, the absorption device quickly activates and clamps the voltage across the supply rails to a safe level.

When the operational amplifier connects into a circuit (see [Figure 38](#)), the ESD protection components are intended to remain inactive and do not become involved in the application circuit operation. However, circumstances may arise where an applied voltage exceeds the operating voltage range of a given pin. If this condition occurs, there is a risk that some internal ESD protection circuits can turn on and conduct current. Any such current flow occurs through steering-diode paths and rarely involves the absorption device.

[Figure 38](#) shows a specific example where the input voltage (V_{IN}) exceeds the positive supply voltage ($V+$) by 500 mV or more. Much of what happens in the circuit depends on the supply characteristics. If $V+$ can sink the current, one of the upper input steering diodes conducts and directs current to $V+$. Excessively high current levels can flow with increasingly higher V_{IN} . As a result, the data sheet specifications recommend that applications limit the input current to 10 mA.

If the supply is not capable of sinking the current, V_{IN} can begin sourcing current to the operational amplifier and then take over as the source of positive supply voltage. The danger in this case is that the voltage can rise to levels that exceed the operational amplifier absolute maximum ratings.

Feature Description (continued)

Another common question involves what happens to the amplifier if an input signal is applied to the input when the power supplies ($V+$ or $V-$) are at 0 V. Again, this question depends on the supply characteristic when at 0 V, or at a level below the input signal amplitude. If the supplies appear as high impedance, then the input source supplies the operational amplifier current through the current-steering diodes. This state is not a normal bias condition; most likely, the amplifier does not operate normally. If the supplies are low impedance, then the current through the steering diodes can become quite high. The current level depends on the ability of the input source to deliver current, and any resistance in the input path.

If there is any uncertainty about the ability of the supply to absorb this current, add external Zener diodes to the supply pins; see [Figure 38](#). Select the Zener voltage so that the diode does not turn on during normal operation. However, the Zener voltage must be low enough so that the Zener diode conducts if the supply pin begins to rise above the safe-operating, supply-voltage level.

The OPAx170-Q1 input pins are protected from excessive differential voltage with back-to-back diodes, as shown in [Figure 38](#). In most circuit applications, the input protection circuitry has no effect. However, in low-gain or $G = 1$ circuits, fast-ramping input signals can forward-bias these diodes because the output of the amplifier cannot respond rapidly enough to the input ramp. If the input signal is fast enough to create this forward-bias condition, limit the input signal current to 10 mA or less. If the input signal current is not inherently limited, an input series resistor can limit the input signal current. This input series resistor degrades the low-noise performance of the OPAx170-Q1. [Figure 38](#) is an example configuration that implements a current-limiting feedback resistor.

7.3.4 Capacitive Load and Stability

The dynamic characteristics of the OPAx170-Q1 are optimized for common operating conditions. The combination of low closed-loop gain and high capacitive loads decreases the phase margin of the amplifier and can lead to gain peaking or oscillations. As a result, heavier capacitive loads must be isolated from the output. The simplest way to achieve this isolation is to add a small resistor (for example, R_{OUT} equal to 50 Ω) in series with the output. [Figure 39](#) and [Figure 40](#) are graphs showing small-signal overshoot versus capacitive load for several values of R_{OUT} . See [Feedback Plots Define Op Amp AC Performance](#) for details of analysis techniques and application circuits.

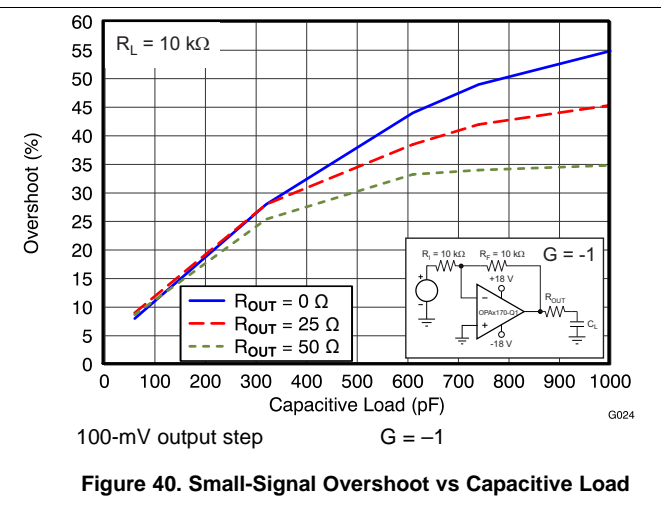
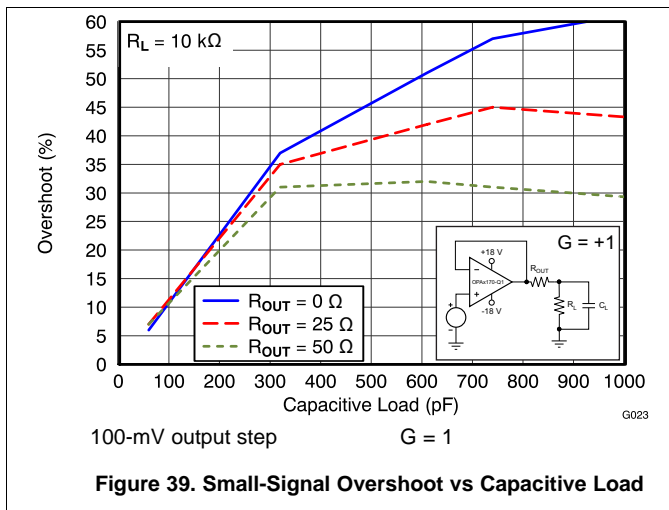

7.4 Device Functional Modes

7.4.1 Common-Mode Voltage Range

The input common-mode voltage range of the OPAx170-Q1 series extends 100 mV below the negative rail and within 2 V of the top rail for normal operation.

This device can operate with full rail-to-rail input 100 mV beyond the top rail, but with reduced performance within 2 V of the top rail. The typical performance in this range is summarized in [Table 5](#).

Table 5. Typical Performance for Common-Mode Voltages Within 2 V of the Positive Supply

PARAMETER	MIN	TYP	MAX	UNIT
Input common-mode voltage	(V+) – 2		(V+) + 0.1	V
Offset voltage		7		mV
	vs temperature	12		μV/°C
Common-mode rejection		65		dB
Open-loop gain		60		dB
Gain-bandwidth product		0.3		MHz
Slew rate		0.3		V/μs

7.4.2 Overload Recovery

Overload recovery is defined as the time required for the operational amplifier output to recover from the saturated state to the linear state. The output devices of the operational amplifier enter the saturation region when the output voltage exceeds the rated operating voltage, either resulting from the high input voltage or the high gain. After the device enters the saturation region, the charge carriers in the output devices need time to return back to the normal state. After the charge carriers return back to the equilibrium state, the device begins to slew at the normal slew rate. Thus, the propagation delay in case of an overload condition is the sum of the overload recovery time and the slew time. The overload recovery time for the OPAx170-Q1 is approximately 2 μs.

8 Application and Implementation

NOTE

Information in the following applications sections is not part of the TI component specification, and TI does not warrant its accuracy or completeness. TI's customers are responsible for determining suitability of components for their purposes. Customers should validate and test their design implementation to confirm system functionality.

8.1 Application Information

The OPAx170-Q1 family of operational amplifiers provides high overall performance in a large number of general-purpose applications. As with all amplifiers, applications with noisy or high-impedance power supplies require decoupling capacitors placed close to the device pins. In most cases, capacitors with a value of 0.1 μF are adequate. Follow the additional recommendations in the [Layout Guidelines](#) section to achieve the maximum performance from this device. Many applications may introduce capacitive loading to the output of the amplifier that may cause instability. Adding an isolation resistor between the amplifier output and the capacitive load stabilizes the amplifier. The design process for selecting this resistor is shown in the [Typical Application](#) section.

8.2 Typical Application

This circuit can drive capacitive loads such as cable shields, reference buffers, MOSFET gates, and diodes. The circuit uses an isolation resistor (R_{ISO}) to stabilize the output of an operational amplifier. R_{ISO} modifies the open-loop gain of the system to ensure the circuit has sufficient phase margin.

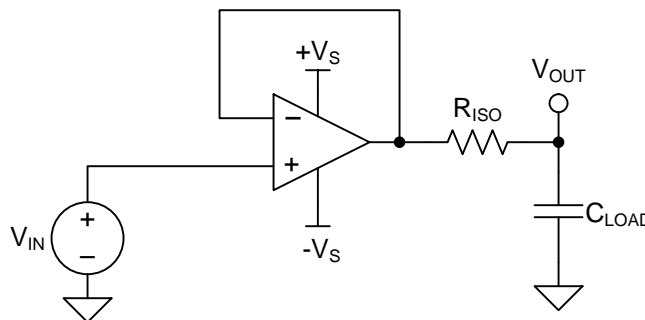

Figure 41. Unity-Gain Buffer With R_{ISO} Stability Compensation

8.2.1 Design Requirements

The design requirements are:

- Supply voltage: 30 V (± 15 V)
- Capacitive loads: 100-pF, 1000-pF, 0.01- μF , 0.1- μF , and 1- μF
- Phase margin: 45° and 60°

8.2.2 Detailed Design Procedure

[Figure 41](#) shows a unity-gain buffer driving a capacitive load. [Equation 1](#) shows the transfer function for the circuit in [Figure 41](#). Not shown in [Figure 41](#) is the open-loop output resistance of the operational amplifier, R_{O} .

$$T(s) = \frac{1 + C_{\text{LOAD}} \times R_{\text{ISO}} \times s}{1 + (R_{\text{O}} + R_{\text{ISO}}) \times C_{\text{LOAD}} \times s} \quad (1)$$

The transfer function in [Equation 1](#) has a pole and a zero. The frequency of the pole (f_p) is determined by $(R_{\text{O}} + R_{\text{ISO}})$ and C_{LOAD} . R_{ISO} and C_{LOAD} determine the frequency of the zero (f_z). A stable system is obtained by selecting R_{ISO} , so the rate of closure (ROC) between the open-loop gain (A_{OL}) and $1/\beta$ is 20 dB / decade. [Figure 42](#) depicts the concept. The $1/\beta$ curve for a unity-gain buffer is 0 dB.

Typical Application (continued)

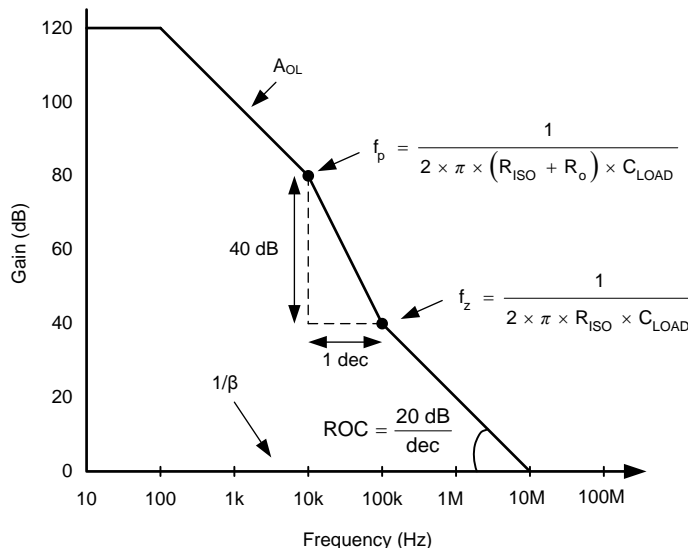

Figure 42. Unity-Gain Amplifier With R_{ISO} Compensation

ROC stability analysis is typically simulated. The validity of the analysis depends on multiple factors, especially the accurate modeling of R_O. In addition to simulating the ROC, a robust stability analysis includes a measurement of overshoot percentage and ac gain peaking of the circuit using a function generator, oscilloscope, and gain and phase analyzer. Phase margin is then calculated from these measurements. Table 6 shows the overshoot percentage and ac gain peaking that correspond to 45° and 60° phase margins. For more details on this design and other alternative devices that can be used in place of the OPAX170-Q1 family, see [Capacitive Load Drive Solution Using an Isolation Resistor](#).

Table 6. Phase Margin versus Overshoot and AC Gain Peaking

PHASE MARGIN	OVERSHOOT	AC GAIN PEAKING
45°	23.3%	2.35 dB
60°	8.8%	0.28 dB

8.2.3 Application Curve

Using the described methodology, the values of R_{ISO} that yield phase margins of 45° and 60° for various capacitive loads were determined. Figure 43 shows the results.

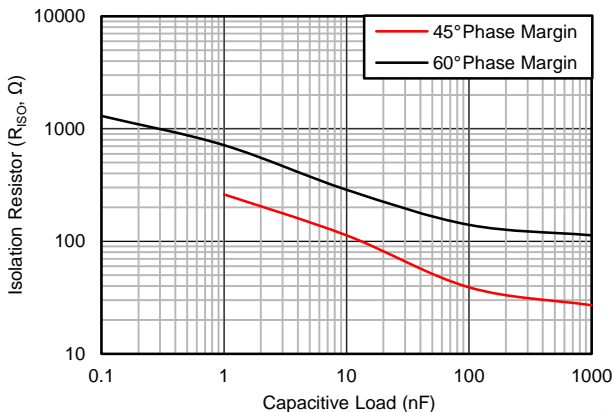

Figure 43. Isolation Resistor Required for Various Capacitive Loads to Achieve a Target Phase Margin

9 Power Supply Recommendations

The OPAx170-Q1 family is specified for operation from 2.7 V to 36 V (± 1.35 V to ± 18 V); many specifications apply from -40°C to $+125^{\circ}\text{C}$. Parameters that can exhibit significant variance with regard to operating voltage or temperature are presented in [Table 4](#).

CAUTION

Supply voltages larger than 40 V can permanently damage the device; see the [Absolute Maximum Ratings](#) table.

Place 0.1- μF bypass capacitors close to the power-supply pins to reduce errors coupling in from noisy or high-impedance power supplies. For more detailed information on bypass capacitor placement, see the [Layout](#) section.

10 Layout

10.1 Layout Guidelines

For best operational performance of the device, use good printed circuit board (PCB) layout practices, including:

- Noise can propagate into analog circuitry through the power pins of the circuit as a whole and the operational amplifier itself. Bypass capacitors are used to reduce the coupled noise by providing low-impedance power sources local to the analog circuitry.
 - Connect low-ESR, 0.1- μF ceramic bypass capacitors between each supply pin and ground, placed as close as possible to the device. A single bypass capacitor from V+ to ground is applicable for single-supply applications.
- Separate grounding for analog and digital portions of circuitry is one of the simplest and most-effective methods of noise suppression. One or more layers on multilayer PCBs are typically devoted to ground planes. A ground plane helps distribute heat and reduces EMI noise pickup. Take care to physically separate digital and analog grounds, paying attention to the flow of the ground current.
- To reduce parasitic coupling, run the input traces as far away as possible from the supply or output traces. If these traces cannot be kept separate, crossing the sensitive trace perpendicularly is much better than in parallel with the noisy trace.
- Place the external components as close as possible to the device. As shown in [Figure 45](#), keeping R_F and R_G close to the inverting input minimizes parasitic capacitance.
- Keep the length of input traces as short as possible. Always remember that the input traces are the most sensitive part of the circuit.
- Consider a driven, low-impedance guard ring around the critical traces. A guard ring can significantly reduce leakage currents from nearby traces that are at different potentials.

10.2 Layout Example

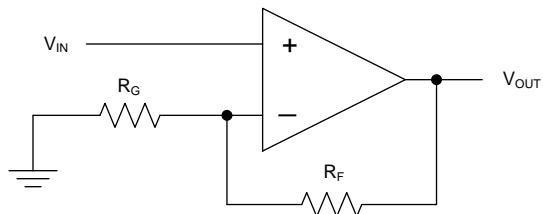
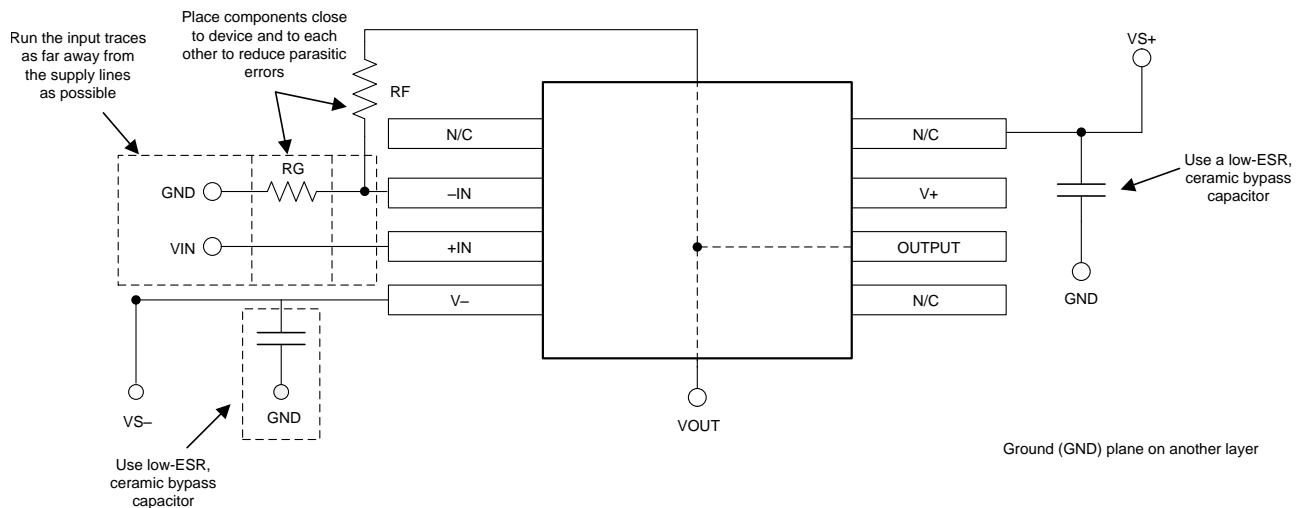

Figure 44. Schematic Representation of a Noninverting Configuration



Copyright © 2017, Texas Instruments Incorporated

Figure 45. Operational Amplifier Board Layout for a Noninverting Configuration

11 Device and Documentation Support

11.1 Device Support

11.1.1 Development Support

11.1.1.1 TINA-TI™ (Free Software Download)

TINA™ is a simple, powerful, and easy-to-use circuit simulation program based on a SPICE engine. TINA-TI™ is a free, fully-functional version of the TINA software, preloaded with a library of macro models in addition to a range of both passive and active models. TINA-TI provides all the conventional dc, transient, and frequency domain analysis of SPICE, as well as additional design capabilities.

Available as a [free download](#) from the WEBENCH® Design Center, TINA-TI offers extensive post-processing capability that allows users to format results in a variety of ways. Virtual instruments offer the ability to select input waveforms and probe circuit nodes, voltages, and waveforms, creating a dynamic quick-start tool.

NOTE

These files require that either the TINA software (from DesignSoft™) or TINA-TI software be installed. Download the free TINA-TI software from the [TINA-TI folder](#).

11.1.1.2 DIP Adapter EVM

The [DIP Adapter EVM](#) tool provides an easy, low-cost way to prototype small surface mount devices. The evaluation tool uses these TI packages: D or U (SOIC-8), PW (TSSOP-8), DGK (MSOP-8), DBV (SOT-23-6, SOT-23-5 and SOT-23-3), DCK (SC70-6 and SC70-5), and DRL (SOT563-6). The DIP Adapter EVM may also be used with terminal strips or may be wired directly to existing circuits.

11.1.1.3 Universal Operational Amplifier EVM

The [Universal Op Amp EVM](#) is a series of general-purpose, blank circuit boards that simplify prototyping circuits for a variety of device package types. The evaluation module board design allows many different circuits to be constructed easily and quickly. Five models are offered, with each model intended for a specific package type. PDIP, SOIC, MSOP, TSSOP and SOT-23 packages are all supported.

NOTE

These boards are unpopulated, so users must provide their own devices. TI recommends requesting several op amp device samples when ordering the Universal Op Amp EVM.

11.1.1.4 TI Precision Designs

TI Precision Designs are analog solutions created by TI's precision analog applications experts and offer the theory of operation, component selection, simulation, complete PCB schematic and layout, bill of materials, and measured performance of many useful circuits. TI Precision Designs are available online at <http://www.ti.com/ww/en/analog/precision-designs/>.

Device Support (continued)

11.1.1.5 WEBENCH® Filter Designer

WEBENCH® Filter Designer is a simple, powerful, and easy-to-use active filter design program. The WEBENCH® Filter Designer allows the user create optimized filter designs using a selection of TI operational amplifiers and passive components from TI's vendor partners.

Available as a web-based tool from the WEBENCH® Design Center, **WEBENCH® Filter Designer** allows the user to design, optimize, and simulate complete multistage active filter solutions within minutes.

11.2 Documentation Support

11.2.1 Related Documentation

For related documentation, see the following (available for download from www.ti.com):

- [Feedback Plots Define Op Amp AC Performance](#)
- [Capacitive Load Drive Solution Using an Isolation Resistor](#)

11.3 Related Links

The table below lists quick access links. Categories include technical documents, support and community resources, tools and software, and quick access to sample or buy.

Table 7. Related Links

PARTS	PRODUCT FOLDER	ORDER NOW	TECHNICAL DOCUMENTS	TOOLS & SOFTWARE	SUPPORT & COMMUNITY
OPA170-Q1	Click here	Click here	Click here	Click here	Click here
OPA2170-Q1	Click here	Click here	Click here	Click here	Click here
OPA4170-Q1	Click here	Click here	Click here	Click here	Click here

11.4 Community Resources

The following links connect to TI community resources. Linked contents are provided "AS IS" by the respective contributors. They do not constitute TI specifications and do not necessarily reflect TI's views; see TI's [Terms of Use](#).

TI E2E™ Online Community *TI's Engineer-to-Engineer (E2E) Community*. Created to foster collaboration among engineers. At e2e.ti.com, you can ask questions, share knowledge, explore ideas and help solve problems with fellow engineers.

Design Support *TI's Design Support* Quickly find helpful E2E forums along with design support tools and contact information for technical support.

11.5 Trademarks

TINA-TI, E2E are trademarks of Texas Instruments.
 WEBENCH is a registered trademark of Texas Instruments.
 TINA, DesignSoft are trademarks of DesignSoft, Inc.
 All other trademarks are the property of their respective owners.

11.6 Electrostatic Discharge Caution



These devices have limited built-in ESD protection. The leads should be shorted together or the device placed in conductive foam during storage or handling to prevent electrostatic damage to the MOS gates.

11.7 Glossary

SLYZ022 — *TI Glossary*.

This glossary lists and explains terms, acronyms, and definitions.

12 Mechanical, Packaging, and Orderable Information

The following pages include mechanical, packaging, and orderable information. This information is the most current data available for the designated devices. This data is subject to change without notice and revision of this document. For browser-based versions of this data sheet, refer to the left-hand navigation.

PACKAGING INFORMATION

Orderable part number	Status (1)	Material type (2)	Package Pins	Package qty Carrier	RoHS (3)	Lead finish/ Ball material (4)	MSL rating/ Peak reflow (5)	Op temp (°C)	Part marking (6)
OPA170AQDBVRQ1	Active	Production	SOT-23 (DBV) 5	3000 LARGE T&R	Yes	NIPDAU SN	Level-3-260C-168 HR	-40 to 125	170Q
OPA170AQDBVRQ1.B	Active	Production	SOT-23 (DBV) 5	3000 LARGE T&R	Yes	NIPDAU	Level-3-260C-168 HR	-40 to 125	170Q
OPA2170AQDGKRQ1	Active	Production	VSSOP (DGK) 8	2500 LARGE T&R	Yes	NIPDAU NIPDAUAG	Level-2-260C-1 YEAR	-40 to 125	2170
OPA2170AQDGKRQ1.B	Active	Production	VSSOP (DGK) 8	2500 LARGE T&R	Yes	NIPDAUAG	Level-2-260C-1 YEAR	-40 to 125	2170
OPA4170AQPWRQ1	Active	Production	TSSOP (PW) 14	2000 LARGE T&R	Yes	NIPDAU	Level-2-260C-1 YEAR	-40 to 125	4170Q1
OPA4170AQPWRQ1.B	Active	Production	TSSOP (PW) 14	2000 LARGE T&R	Yes	NIPDAU	Level-2-260C-1 YEAR	-40 to 125	4170Q1

(1) **Status:** For more details on status, see our [product life cycle](#).

(2) **Material type:** When designated, preproduction parts are prototypes/experimental devices, and are not yet approved or released for full production. Testing and final process, including without limitation quality assurance, reliability performance testing, and/or process qualification, may not yet be complete, and this item is subject to further changes or possible discontinuation. If available for ordering, purchases will be subject to an additional waiver at checkout, and are intended for early internal evaluation purposes only. These items are sold without warranties of any kind.

(3) **RoHS values:** Yes, No, RoHS Exempt. See the [TI RoHS Statement](#) for additional information and value definition.

(4) **Lead finish/Ball material:** Parts may have multiple material finish options. Finish options are separated by a vertical ruled line. Lead finish/Ball material values may wrap to two lines if the finish value exceeds the maximum column width.

(5) **MSL rating/Peak reflow:** The moisture sensitivity level ratings and peak solder (reflow) temperatures. In the event that a part has multiple moisture sensitivity ratings, only the lowest level per JEDEC standards is shown. Refer to the shipping label for the actual reflow temperature that will be used to mount the part to the printed circuit board.

(6) **Part marking:** There may be an additional marking, which relates to the logo, the lot trace code information, or the environmental category of the part.

Multiple part markings will be inside parentheses. Only one part marking contained in parentheses and separated by a "~" will appear on a part. If a line is indented then it is a continuation of the previous line and the two combined represent the entire part marking for that device.

Important Information and Disclaimer:The information provided on this page represents TI's knowledge and belief as of the date that it is provided. TI bases its knowledge and belief on information provided by third parties, and makes no representation or warranty as to the accuracy of such information. Efforts are underway to better integrate information from third parties. TI has taken and continues to take reasonable steps to provide representative and accurate information but may not have conducted destructive testing or chemical analysis on incoming materials and chemicals. TI and TI suppliers consider certain information to be proprietary, and thus CAS numbers and other limited information may not be available for release.

In no event shall TI's liability arising out of such information exceed the total purchase price of the TI part(s) at issue in this document sold by TI to Customer on an annual basis.

OTHER QUALIFIED VERSIONS OF OPA170-Q1, OPA2170-Q1, OPA4170-Q1 :

- Catalog : [OPA170](#), [OPA2170](#), [OPA4170](#)
- Enhanced Product : [OPA170-EP](#)

NOTE: Qualified Version Definitions:

- Catalog - TI's standard catalog product
- Enhanced Product - Supports Defense, Aerospace and Medical Applications

TAPE AND REEL INFORMATION

QUADRANT ASSIGNMENTS FOR PIN 1 ORIENTATION IN TAPE

*All dimensions are nominal

Device	Package Type	Package Drawing	Pins	SPQ	Reel Diameter (mm)	Reel Width W1 (mm)	A0 (mm)	B0 (mm)	K0 (mm)	P1 (mm)	W (mm)	Pin1 Quadrant
OPA170AQBVRQ1	SOT-23	DBV	5	3000	178.0	9.0	3.3	3.2	1.4	4.0	8.0	Q3
OPA2170AQDGKRQ1	VSSOP	DGK	8	2500	330.0	12.4	5.3	3.4	1.4	8.0	12.0	Q1
OPA4170AQPWRQ1	TSSOP	PW	14	2000	330.0	12.4	6.9	5.6	1.6	8.0	12.0	Q1

TAPE AND REEL BOX DIMENSIONS



*All dimensions are nominal

Device	Package Type	Package Drawing	Pins	SPQ	Length (mm)	Width (mm)	Height (mm)
OPA170AQDBVRQ1	SOT-23	DBV	5	3000	180.0	180.0	18.0
OPA2170AQDGKRQ1	VSSOP	DGK	8	2500	353.0	353.0	32.0
OPA4170AQPWRQ1	TSSOP	PW	14	2000	353.0	353.0	32.0

EXAMPLE BOARD LAYOUT

DBV0005A

SOT-23 - 1.45 mm max height

SMALL OUTLINE TRANSISTOR



LAND PATTERN EXAMPLE
EXPOSED METAL SHOWN
SCALE:15X



SOLDER MASK DETAILS

4214839/K 08/2024

NOTES: (continued)

- 6. Publication IPC-7351 may have alternate designs.
- 7. Solder mask tolerances between and around signal pads can vary based on board fabrication site.

EXAMPLE STENCIL DESIGN

DBV0005A

SOT-23 - 1.45 mm max height

SMALL OUTLINE TRANSISTOR



SOLDER PASTE EXAMPLE
BASED ON 0.125 mm THICK STENCIL
SCALE:15X

4214839/K 08/2024

NOTES: (continued)

8. Laser cutting apertures with trapezoidal walls and rounded corners may offer better paste release. IPC-7525 may have alternate design recommendations.
9. Board assembly site may have different recommendations for stencil design.

DGK0008A



PACKAGE OUTLINE

VSSOP - 1.1 mm max height

SMALL OUTLINE PACKAGE



NOTES:

PowerPAD is a trademark of Texas Instruments.

1. All linear dimensions are in millimeters. Any dimensions in parenthesis are for reference only. Dimensioning and tolerancing per ASME Y14.5M.
2. This drawing is subject to change without notice.
3. This dimension does not include mold flash, protrusions, or gate burrs. Mold flash, protrusions, or gate burrs shall not exceed 0.15 mm per side.
4. This dimension does not include interlead flash. Interlead flash shall not exceed 0.25 mm per side.
5. Reference JEDEC registration MO-187.

EXAMPLE BOARD LAYOUT

DGK0008A

™ VSSOP - 1.1 mm max height

SMALL OUTLINE PACKAGE



LAND PATTERN EXAMPLE
EXPOSED METAL SHOWN
SCALE: 15X



4214862/A 04/2023

NOTES: (continued)

6. Publication IPC-7351 may have alternate designs.
7. Solder mask tolerances between and around signal pads can vary based on board fabrication site.
8. Vias are optional depending on application, refer to device data sheet. If any vias are implemented, refer to their locations shown on this view. It is recommended that vias under paste be filled, plugged or tented.
9. Size of metal pad may vary due to creepage requirement.

EXAMPLE STENCIL DESIGN

DGK0008A

™ VSSOP - 1.1 mm max height

SMALL OUTLINE PACKAGE



SOLDER PASTE EXAMPLE
SCALE: 15X

4214862/A 04/2023

NOTES: (continued)

11. Laser cutting apertures with trapezoidal walls and rounded corners may offer better paste release. IPC-7525 may have alternate design recommendations.
12. Board assembly site may have different recommendations for stencil design.

PW0014A

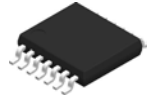

PACKAGE OUTLINE

TSSOP - 1.2 mm max height

SMALL OUTLINE PACKAGE



4220202/B 12/2023

NOTES:

1. All linear dimensions are in millimeters. Any dimensions in parenthesis are for reference only. Dimensioning and tolerancing per ASME Y14.5M.
2. This drawing is subject to change without notice.
3. This dimension does not include mold flash, protrusions, or gate burrs. Mold flash, protrusions, or gate burrs shall not exceed 0.15 mm per side.
4. This dimension does not include interlead flash. Interlead flash shall not exceed 0.25 mm per side.
5. Reference JEDEC registration MO-153.

EXAMPLE BOARD LAYOUT

PW0014A

TSSOP - 1.2 mm max height

SMALL OUTLINE PACKAGE



LAND PATTERN EXAMPLE
EXPOSED METAL SHOWN
SCALE: 10X



4220202/B 12/2023

NOTES: (continued)

- 6. Publication IPC-7351 may have alternate designs.
- 7. Solder mask tolerances between and around signal pads can vary based on board fabrication site.

EXAMPLE STENCIL DESIGN

PW0014A

TSSOP - 1.2 mm max height

SMALL OUTLINE PACKAGE



SOLDER PASTE EXAMPLE
BASED ON 0.125 mm THICK STENCIL
SCALE: 10X

4220202/B 12/2023

NOTES: (continued)

8. Laser cutting apertures with trapezoidal walls and rounded corners may offer better paste release. IPC-7525 may have alternate design recommendations.
9. Board assembly site may have different recommendations for stencil design.

IMPORTANT NOTICE AND DISCLAIMER

TI PROVIDES TECHNICAL AND RELIABILITY DATA (INCLUDING DATASHEETS), DESIGN RESOURCES (INCLUDING REFERENCE DESIGNS), APPLICATION OR OTHER DESIGN ADVICE, WEB TOOLS, SAFETY INFORMATION, AND OTHER RESOURCES "AS IS" AND WITH ALL FAULTS, AND DISCLAIMS ALL WARRANTIES, EXPRESS AND IMPLIED, INCLUDING WITHOUT LIMITATION ANY IMPLIED WARRANTIES OF MERCHANTABILITY, FITNESS FOR A PARTICULAR PURPOSE OR NON-INFRINGEMENT OF THIRD PARTY INTELLECTUAL PROPERTY RIGHTS.

These resources are intended for skilled developers designing with TI products. You are solely responsible for (1) selecting the appropriate TI products for your application, (2) designing, validating and testing your application, and (3) ensuring your application meets applicable standards, and any other safety, security, regulatory or other requirements.

These resources are subject to change without notice. TI grants you permission to use these resources only for development of an application that uses the TI products described in the resource. Other reproduction and display of these resources is prohibited. No license is granted to any other TI intellectual property right or to any third party intellectual property right. TI disclaims responsibility for, and you fully indemnify TI and its representatives against any claims, damages, costs, losses, and liabilities arising out of your use of these resources.

TI's products are provided subject to [TI's Terms of Sale](#), [TI's General Quality Guidelines](#), or other applicable terms available either on [ti.com](#) or provided in conjunction with such TI products. TI's provision of these resources does not expand or otherwise alter TI's applicable warranties or warranty disclaimers for TI products. Unless TI explicitly designates a product as custom or customer-specified, TI products are standard, catalog, general purpose devices.

TI objects to and rejects any additional or different terms you may propose.

Copyright © 2025, Texas Instruments Incorporated

Last updated 10/2025