

QUAD DIFFERENTIAL COMPARATOR

 Check for Samples: [LM139-SP](#), [LM139A-SP](#)

FEATURES

- QML-V Qualified, SMD 5962-7700801VCA, 5962-9673802VCA and 5962-9673802V9B
 - Rad-Tolerant: 40 kRad/sec (Si) TID (5962-9673802VCA and 5962-9673802V9B) ⁽¹⁾
 - TID Dose Rate = 0.01 rad/sec (Si)
 - Wide Supply Ranges
 - Single Supply: 2 V to 36 V (Tested to 30 V)
 - Dual Supplies: ±1 V to ±18 V (Tested to ±15 V)
 - Low Supply-Current Drain Independent of Supply Voltage: 0.8 mA (Typ)
 - Low Input Bias Current: 25 nA (Typ)
 - Low Input Offset Current: 3 nA (Typ) (LM139)
 - Low Input Offset Voltage: 2 mV (Typ)
- Common-Mode Input Voltage Range Includes Ground
 - Differential Input Voltage Range Equal to Maximum-Rated Supply Voltage: ±36 V
 - Low Output Saturation Voltage
 - Output Compatible With TTL, MOS, and CMOS

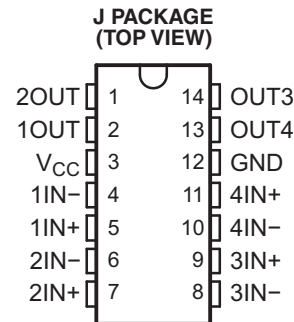

(1) Radiation tolerance is a typical value based upon initial device qualification with dose rate = 0.01 rad/sec. Radiation lot acceptance testing is available - contact factory for details.

DESCRIPTION/ORDERING INFORMATION

These devices consist of four independent voltage comparators that are designed to operate from a single power supply over a wide range of voltages. Operation from dual supplies also is possible, as long as the difference between the two supplies is 2 V to 36 V, and V_{CC} is at least 1.5 V more positive than the input common-mode voltage. Current drain is independent of the supply voltage. The outputs can be connected to other open-collector outputs to achieve wired-AND relationships.

The LM139 and LM139A are characterized for operation over the full military temperature range of -55°C to 125°C .

Table 1. ORDERING INFORMATION ⁽¹⁾

T_A	V_{IOmax} AT 25°C	MAX V_{CC}	PACKAGE ⁽²⁾	ORDERABLE PART NUMBER		TOP-SIDE MARKING
-55°C to 125°C	5 mV	30 V	J	LM139	5962-7700801VCA	5962-7700801VCA
	2 mV	30 V		LM139A	5962-9673802VCA ⁽³⁾	5962-9673802VCA
	2 mV	30 V	KGD	5962-9673802V9B ⁽³⁾		N/A

- (1) For the most current package and ordering information, see the Package Option Addendum at the end of this document, or see the TI web site at www.ti.com.
- (2) Package drawings, thermal data, and symbolization are available at www.ti.com/packaging.
- (3) Radiation tolerant



Please be aware that an important notice concerning availability, standard warranty, and use in critical applications of Texas Instruments semiconductor products and disclaimers thereto appears at the end of this data sheet.

BARE DIE INFORMATION

DIE THICKNESS	BACKSIDE FINISH	BACKSIDE POTENTIAL	BON PAD METALLIZATION COMPOSITION	BOND PAD THICKNESS
15 mils	Silicon with backgrind	Floating	AlCu (0.5%)	0.055 mils

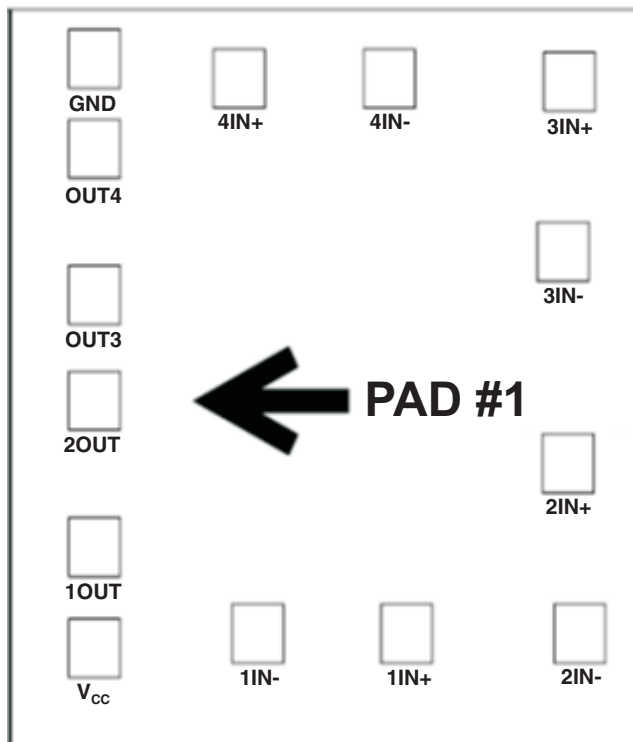
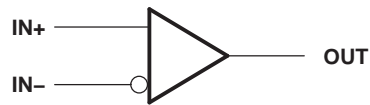

Table 2. Bond Pad Coordinates in Microns

DISCRIPTION	PAD NUMBER	Xmin	Ymin	Xmax	Ymax
2OUT	1	22.86	455.93	124.46	557.53
1OUT	2	22.86	203.2	124.46	304.8
Vcc	3	22.86	27.94	124.46	129.54
1IN-	4	345.44	53.34	447.04	154.94
1IN+	5	640.08	53.34	741.68	154.94
2IN-	6	981.71	53.34	1083.31	154.94
2IN+	7	958.85	347.98	1060.45	449.58
3IN-	8	948.69	713.74	1050.29	815.34
3IN+	9	961.39	1008.38	1062.99	1109.98
4IN-	10	605.79	1013.46	707.39	1115.06
4IN+	11	308.61	1013.46	410.21	1115.06
GND	12	22.86	1047.75	124.46	1149.35
OUT4	13	22.86	891.54	124.46	993.14
OUT3	14	22.86	638.81	124.46	740.41

SYMBOL (EACH COMPARATOR)



SCHEMATIC (EACH COMPARATOR)

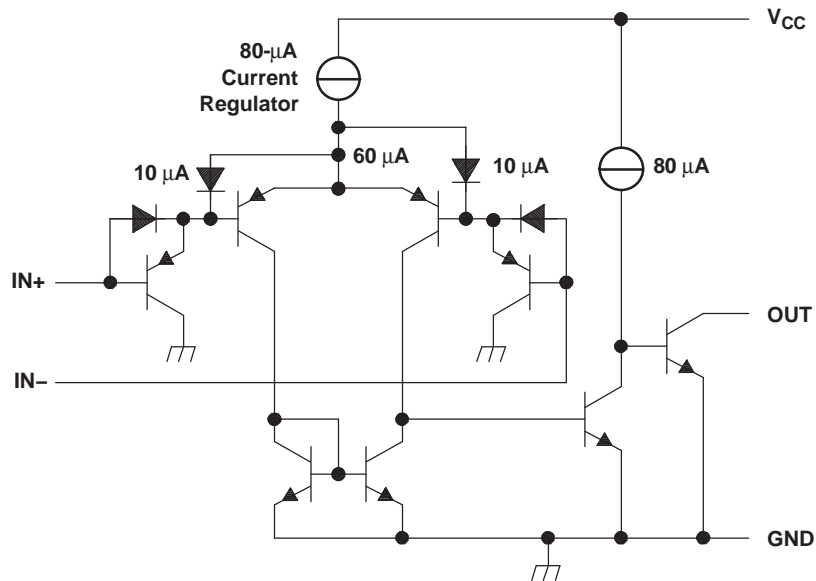

All current values shown are nominal.

ABSOLUTE MAXIMUM RATINGS⁽¹⁾

over operating free-air temperature range (unless otherwise noted)

			MIN	MAX	UNIT
V _{CC}	Supply voltage ⁽²⁾			36	V
V _{ID}	Differential input voltage ⁽³⁾			±36	V
V _I	Input voltage range (either input)		-0.3	36	V
V _O	Output voltage			36	V
I _O	Output current			20	mA
	Duration of output short circuit to ground ⁽⁴⁾			Unlimited	
θ _{JC}	Package thermal impedance, junction to case ^{(5) (6)}	J package		15.05	°C/W
T _J	Operating virtual-junction temperature			150	°C
	Lead temperature 1,6 mm (1/16 in) from case for 60 s	J package		300	°C
T _{stg}	Storage temperature range		-65	150	°C

- (1) Stresses beyond those listed under "absolute maximum ratings" may cause permanent damage to the device. These are stress ratings only, and functional operation of the device at these or any other conditions beyond those indicated under "recommended operating conditions" is not implied. Exposure to absolute-maximum-rated conditions for extended periods may affect device reliability.
- (2) All voltage values, except differential voltages, are with respect to network ground.
- (3) Differential voltages are at IN+ with respect to IN-.
- (4) Short circuits from outputs to V_{CC} can cause excessive heating and eventual destruction.
- (5) Maximum power dissipation is a function of T_J (max), θ_{JC}, and T_C. The maximum allowable power dissipation at any allowable case temperature is $P_D = (T_J(\text{max}) - T_C) / \theta_{JC}$. Operating at the absolute maximum T_J of 150°C can affect reliability.
- (6) The package thermal impedance is calculated in accordance with MIL-STD-883.

ELECTRICAL CHARACTERISTICS FOR LM139

 at specified free-air temperature, $V_{CC} = 5\text{ V}$ (unless otherwise noted)

PARAMETER		TEST CONDITIONS ⁽¹⁾		T_A ⁽²⁾	MIN	TYP	MAX	UNIT
V_{IO}	Input offset voltage	$V_{CC} = 5\text{ V to }30\text{ V}$, $V_{IC} = V_{ICR\text{ min}}$, $V_O = 1.4\text{ V}$		25°C	1			mV
				Full range	4			
I_{IO}	Input offset current	$V_O = 1.4\text{ V}$		25°C	3 25			nA
				Full range	100			
I_{IB}	Input bias current	$V_O = 1.4\text{ V}$		25°C	-25 -100			nA
				Full range	-300			
V_{ICR}	Common-mode input-voltage range ⁽³⁾			25°C	0 to $V_{CC} - 1.5$			V
				Full range	0 to $V_{CC} - 2$			
A_{VD}	Large-signal differential-voltage amplification	$V_{CC+} = \pm 7.5\text{ V}$, $V_O = -5\text{ V to }5\text{ V}$		25°C	50	200		V/mV
I_{OH}	High-level output current	$V_{ID} = 1\text{ V}$	$V_{OH} = 5\text{ V}$	25°C	0.1			nA
			$V_{OH} = 30\text{ V}$	Full range	1			μA
V_{OL}	Low-level output voltage	$V_{ID} = -1\text{ V}$, $I_{OL} = 4\text{ mA}$		25°C	150 400			mV
				Full range	700			
I_{OL}	Low-level output current	$V_{ID} = -1\text{ V}$, $V_{OL} = 1.5\text{ V}$		25°C	6	16		mA
I_{CC}	Supply current (four comparators)	$V_O = 2.5\text{ V}$, No load		25°C	0.8 2			mA

- (1) All characteristics are measured with zero common-mode input voltage, unless otherwise specified.
- (2) Full range (MIN to MAX) for LM139 and LM139A is -55°C to 125°C . All characteristics are measured with zero common-mode input voltage, unless otherwise specified.
- (3) The voltage at either input or common-mode should not be allowed to go negative by more than 0.3 V. The upper end of the common-mode voltage range is $V_{CC+} - 1.5\text{ V}$; however, one input can exceed V_{CC+} , and the comparator will provide a proper output state as long as the other input remains in the common-mode range. Either or both inputs can go to 30 V without damage.

ELECTRICAL CHARACTERISTICS FOR LM139A

at specified free-air temperature, $V_{CC} = 5\text{ V}$ (unless otherwise noted)

PARAMETER		TEST CONDITIONS ⁽¹⁾	T_A ⁽²⁾	MIN	TYP ⁽³⁾	MAX	UNIT
I_{CC}	Supply current	$R_L = \infty$, $V_+ = 30\text{ V}$	Full range			2	mA
I_{CEX}	Output leakage current	$V_+ = 30\text{ V}$, $V_{OUT} = 30\text{ V}$	Full range			1	μA
V_{SAT}	Saturation voltage	$I_{SINK} = 4\text{ mA}$	25°C			400	mV
			Full range			700	
I_{SINK}	Output sink current	$V_{OUT} = 1.5\text{ V}$	25°C		6		mA
V_{IO}	Input offset voltage	$V_+ = 5\text{ V}$, $V_{CM} = 0\text{ V}$	25°C			± 2	mV
			Full range			± 4	
		$V_+ = 30\text{ V}$, $V_{CM} = 0\text{ V}$	25°C			± 2	mV
			Full range			± 4	
		$V_+ = 30\text{ V}$, $V_{CM} = 28.5\text{ V}$, $V_{OUT} = 1.5\text{ V}$	25°C			± 2	mV
$V_+ = 30\text{ V}$, $V_{CM} = 28\text{ V}$, $V_{OUT} = 1.5\text{ V}$	Full range			± 4	mV		
I_{IB}	Input bias current	$V_{OUT} = 1.5\text{ V}$	25°C	-100		-1	nA
			Full range	-300		-1	
I_{IO}	Input offset current	$V_{OUT} = 1.5\text{ V}$	25°C			± 25	nA
			Full range			± 100	
PSRR	Power supply rejection ratio	$V_+ = 5\text{ V}$ to 30 V	25°C	60		100	dB
CMRR	Common-mode rejection ratio	$V_+ = 30\text{ V}$, $V_{CM} = 0\text{ V}$ to 28.5 V	25°C	60			dB
A_V	Voltage gain	$V_+ = 15\text{ V}$, $R_L \geq 15\text{ k}\Omega$, $V_{OUT} = 1\text{ V}$ to 11 V	25°C	50			V/mV
V_{CM} ⁽⁴⁾	Common mode voltage range	$V_+ = 30\text{ V}$	25°C	0		$V_+ - 1.5$	V
			Full range	0		$V_+ - 2$	
V_{DIFF} ⁽⁵⁾	Differential input voltage	$V_+ = 30\text{ V}$, $V_- = 0\text{ V}$, $V_{IN+} = 36\text{ V}$, $V_{IN-} = 0\text{ V}$	Full range			500	nA
		$V_+ = 30\text{ V}$, $V_- = 0\text{ V}$, $V_{IN+} = 0\text{ V}$, $V_{IN-} = 36\text{ V}$				500	
t_{RLH}	Response time	V_{OD} (overdrive) = 5 mV	25°C			5	μs
		V_{OD} (overdrive) = 50 mV				0.8	
t_{RHL}	Response time	V_{OD} (overdrive) = 5 mV	25°C			2.5	μs
		V_{OD} (overdrive) = 50 mV				0.8	

- (1) All characteristics are measured under open-loop conditions, with zero common-mode input voltage, unless otherwise specified. MAX V_{CC} for testing purposes is 30 V .
- (2) Full range is -55°C to 125°C for LM139A.
- (3) All typical values are at $T_A = 25^\circ\text{C}$.
- (4) The input common mode voltage or either input signal voltage should not be allowed to go negative by more than 0.3 V . The upper end of the common mode voltage range is $V_+ - 1.5\text{ V}$ for $T_A = 25^\circ\text{C}$ or $V_+ - 2.0\text{ V}$ for $T_A = \text{Full range}$, but either or both inputs can go to $+30\text{ V}$ dc without damage independent of the magnitude of V_+ .
- (5) Positive excursions of input voltage may exceed the power supply level. As long as the other voltage remains within the common mode range, the comparator will provide a proper output state. The low input voltage state must not be less than -0.3 V dc or 0.3 V dc below the magnitude of the negative power supply, if used.

SWITCHING CHARACTERISTICS

 $V_{CC} = 5\text{ V}$, $T_A = 25^\circ\text{C}$

PARAMETER	TEST CONDITIONS	TYP	UNIT
Response time	R_L connected to 5 V through 5.1 k Ω , $C_L = 15\text{ pF}^{(1)}\text{ }^{(2)}$	100-mV input step with 5-mV overdrive	1.3
		TTL-level input step	0.3

(1) C_L includes probe and jig capacitance.

(2) The response time specified is the interval between the input step function and the instant when the output crosses 1.4 V.

TYPICAL CHARACTERISTICS

SUPPLY CURRENT
vs
SUPPLY VOLTAGE

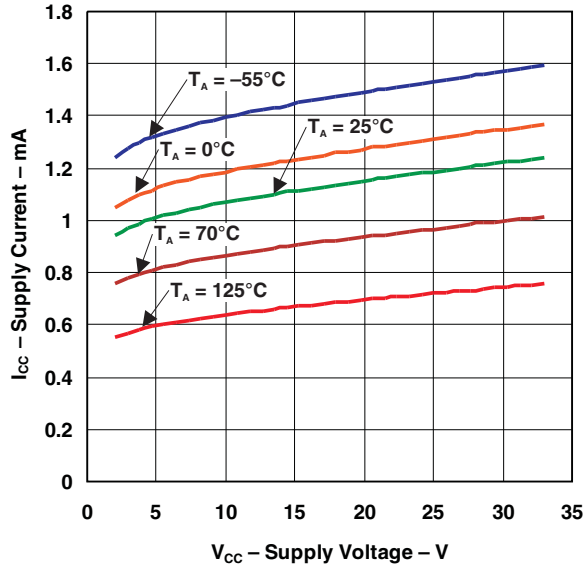

INPUT BIAS CURRENT
vs
SUPPLY VOLTAGE

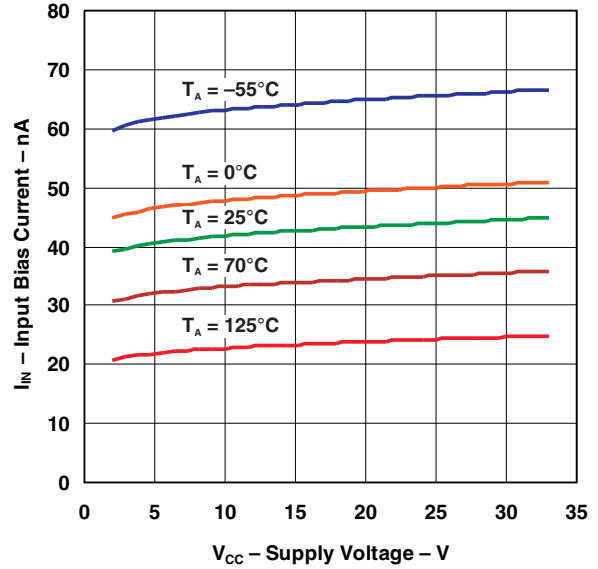

OUTPUT SATURATION VOLTAGE

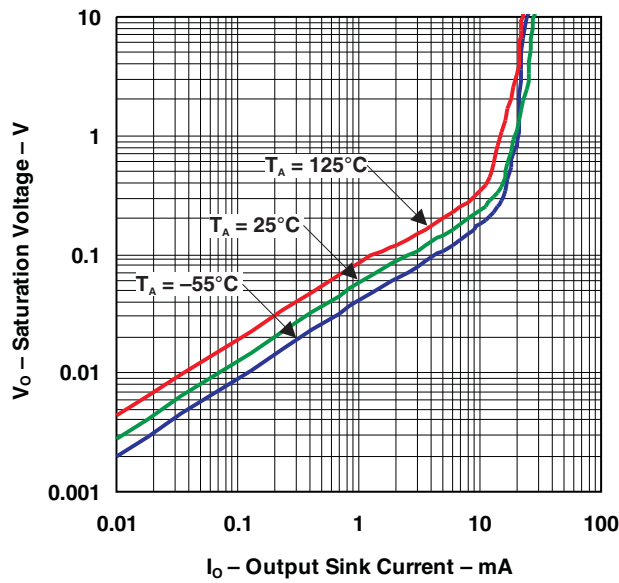

TYPICAL CHARACTERISTICS (continued)

RESPONSE TIME FOR VARIOUS OVERDRIVES
NEGATIVE TRANSITION

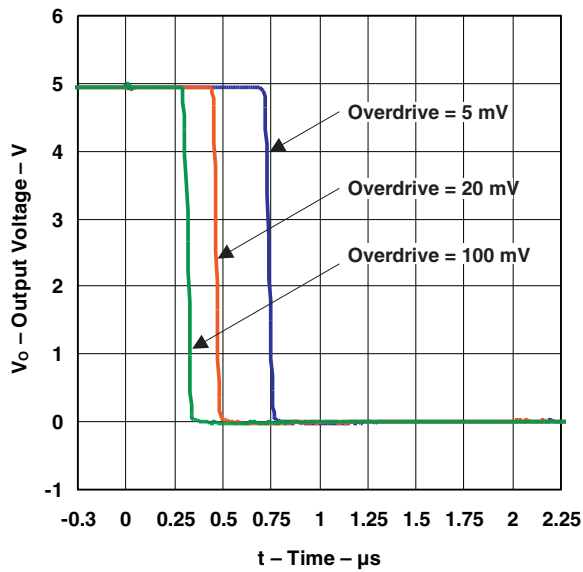

RESPONSE TIME FOR VARIOUS OVERDRIVES
POSITIVE TRANSITION

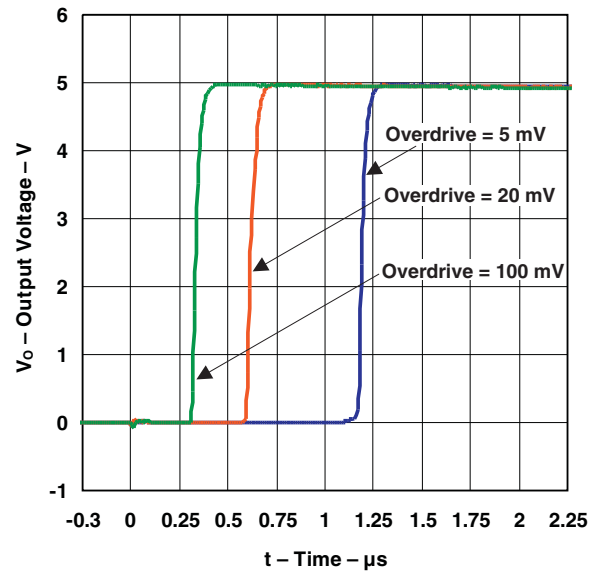

PACKAGING INFORMATION

Orderable part number	Status (1)	Material type (2)	Package Pins	Package qty Carrier	RoHS (3)	Lead finish/ Ball material (4)	MSL rating/ Peak reflow (5)	Op temp (°C)	Part marking (6)
5962-7700801VCA	Active	Production	CDIP (J) 14	25 TUBE	No	SNPB	N/A for Pkg Type	-55 to 125	5962-7700801VC A LM139JQMLV
5962-7700801VCA.A	Active	Production	CDIP (J) 14	25 TUBE	No	SNPB	N/A for Pkg Type	-55 to 125	5962-7700801VC A LM139JQMLV
5962-9673802V9B	Active	Production	XCEPT (KGD) 0	100 BULK	Yes	Call TI	N/A for Pkg Type	-55 to 125	
5962-9673802V9B.A	Active	Production	XCEPT (KGD) 0	100 BULK	Yes	Call TI	N/A for Pkg Type	-55 to 125	
5962-9673802VCA	Active	Production	CDIP (J) 14	25 TUBE	No	SNPB	N/A for Pkg Type	-55 to 125	5962-9673802VC A LM139AJQMLV
5962-9673802VCA.A	Active	Production	CDIP (J) 14	25 TUBE	No	SNPB	N/A for Pkg Type	-55 to 125	5962-9673802VC A LM139AJQMLV

(1) **Status:** For more details on status, see our [product life cycle](#).

(2) **Material type:** When designated, preproduction parts are prototypes/experimental devices, and are not yet approved or released for full production. Testing and final process, including without limitation quality assurance, reliability performance testing, and/or process qualification, may not yet be complete, and this item is subject to further changes or possible discontinuation. If available for ordering, purchases will be subject to an additional waiver at checkout, and are intended for early internal evaluation purposes only. These items are sold without warranties of any kind.

(3) **RoHS values:** Yes, No, RoHS Exempt. See the [TI RoHS Statement](#) for additional information and value definition.

(4) **Lead finish/Ball material:** Parts may have multiple material finish options. Finish options are separated by a vertical ruled line. Lead finish/Ball material values may wrap to two lines if the finish value exceeds the maximum column width.

(5) **MSL rating/Peak reflow:** The moisture sensitivity level ratings and peak solder (reflow) temperatures. In the event that a part has multiple moisture sensitivity ratings, only the lowest level per JEDEC standards is shown. Refer to the shipping label for the actual reflow temperature that will be used to mount the part to the printed circuit board.

(6) **Part marking:** There may be an additional marking, which relates to the logo, the lot trace code information, or the environmental category of the part.

Multiple part markings will be inside parentheses. Only one part marking contained in parentheses and separated by a "~" will appear on a part. If a line is indented then it is a continuation of the previous line and the two combined represent the entire part marking for that device.

Important Information and Disclaimer:The information provided on this page represents TI's knowledge and belief as of the date that it is provided. TI bases its knowledge and belief on information provided by third parties, and makes no representation or warranty as to the accuracy of such information. Efforts are underway to better integrate information from third parties. TI has taken and continues to take reasonable steps to provide representative and accurate information but may not have conducted destructive testing or chemical analysis on incoming materials and chemicals. TI and TI suppliers consider certain information to be proprietary, and thus CAS numbers and other limited information may not be available for release.

In no event shall TI's liability arising out of such information exceed the total purchase price of the TI part(s) at issue in this document sold by TI to Customer on an annual basis.

OTHER QUALIFIED VERSIONS OF LM139-SP :

- Catalog : [LM139](#)

NOTE: Qualified Version Definitions:

- Catalog - TI's standard catalog product

TUBE

*All dimensions are nominal

Device	Package Name	Package Type	Pins	SPQ	L (mm)	W (mm)	T (μm)	B (mm)
5962-9673802VCA	J	CDIP	14	25	506.98	15.24	13440	NA
5962-9673802VCA.A	J	CDIP	14	25	506.98	15.24	13440	NA

J 14

GENERIC PACKAGE VIEW
CDIP - 5.08 mm max height
CERAMIC DUAL IN LINE PACKAGE



Images above are just a representation of the package family, actual package may vary.
Refer to the product data sheet for package details.

4040083-5/G

J0014A



PACKAGE OUTLINE

CDIP - 5.08 mm max height

CERAMIC DUAL IN LINE PACKAGE



4214771/A 05/2017

NOTES:

1. All controlling linear dimensions are in inches. Dimensions in brackets are in millimeters. Any dimension in brackets or parenthesis are for reference only. Dimensioning and tolerancing per ASME Y14.5M.
2. This drawing is subject to change without notice.
3. This package is hermetically sealed with a ceramic lid using glass frit.
4. Index point is provided on cap for terminal identification only and on press ceramic glass frit seal only.
5. Falls within MIL-STD-1835 and GDIP1-T14.

EXAMPLE BOARD LAYOUT

J0014A

CDIP - 5.08 mm max height

CERAMIC DUAL IN LINE PACKAGE



LAND PATTERN EXAMPLE
NON-SOLDER MASK DEFINED
SCALE: 5X



4214771/A 05/2017

IMPORTANT NOTICE AND DISCLAIMER

TI PROVIDES TECHNICAL AND RELIABILITY DATA (INCLUDING DATASHEETS), DESIGN RESOURCES (INCLUDING REFERENCE DESIGNS), APPLICATION OR OTHER DESIGN ADVICE, WEB TOOLS, SAFETY INFORMATION, AND OTHER RESOURCES "AS IS" AND WITH ALL FAULTS, AND DISCLAIMS ALL WARRANTIES, EXPRESS AND IMPLIED, INCLUDING WITHOUT LIMITATION ANY IMPLIED WARRANTIES OF MERCHANTABILITY, FITNESS FOR A PARTICULAR PURPOSE OR NON-INFRINGEMENT OF THIRD PARTY INTELLECTUAL PROPERTY RIGHTS.

These resources are intended for skilled developers designing with TI products. You are solely responsible for (1) selecting the appropriate TI products for your application, (2) designing, validating and testing your application, and (3) ensuring your application meets applicable standards, and any other safety, security, regulatory or other requirements.

These resources are subject to change without notice. TI grants you permission to use these resources only for development of an application that uses the TI products described in the resource. Other reproduction and display of these resources is prohibited. No license is granted to any other TI intellectual property right or to any third party intellectual property right. TI disclaims responsibility for, and you fully indemnify TI and its representatives against any claims, damages, costs, losses, and liabilities arising out of your use of these resources.

TI's products are provided subject to [TI's Terms of Sale](#), [TI's General Quality Guidelines](#), or other applicable terms available either on ti.com or provided in conjunction with such TI products. TI's provision of these resources does not expand or otherwise alter TI's applicable warranties or warranty disclaimers for TI products. Unless TI explicitly designates a product as custom or customer-specified, TI products are standard, catalog, general purpose devices.

TI objects to and rejects any additional or different terms you may propose.

Copyright © 2025, Texas Instruments Incorporated

Last updated 10/2025