

ADC122S625 Dual 12-Bit, 50 kSPS to 200 kSPS, Simultaneous Sampling A/D Converter

Check for Samples: [ADC122S625](#)

FEATURES

- True Simultaneous Sampling Differential Inputs
- Specified Performance from 50 kSPS to 200 kSPS
- External Reference
- Wide Input Common-Mode Voltage Range
- Single High-Speed Serial Data Output
- Operating Temperature Range of -40°C to $+105^{\circ}\text{C}$
- SPI™/ QSPI™/ MICROWIRE™/ DSP Compatible Serial Interface

APPLICATIONS

- Motor Control
- Power Meters/Monitors
- Multi-Axis Positioning Systems
- Instrumentation and Control Systems
- Data Acquisition Systems
- Medical Instruments
- Direct Sensor Interface

KEY SPECIFICATIONS

- Conversion Rate: 50 kSPS to 200 kSPS
- INL: ± 1 LSB (max)
- DNL: ± 0.95 LSB (max)
- SNR: 71 dBc (min)
- THD: -72 dBc (min)
- ENOB: 11.25 bits (min)
- Power Consumption at 200 kSPS
 - Converting, $V_A = 5\text{V}$, $V_{REF} = 2.5\text{V}$: 8.6 mW (typ)
 - Power-Down, $V_A = 5\text{V}$, $V_{REF} = 2.5\text{V}$: 2.6 μW (typ)

DESCRIPTION

The ADC122S625 is a dual 12-bit, 50 kSPS to 200 kSPS simultaneous sampling Analog-to-Digital (A/D) converter. The analog inputs on both channels are sampled simultaneously to preserve their relative phase information to each other. The converter is based on a successive-approximation register architecture where the differential nature of the analog inputs is maintained from the internal track-and-hold circuits throughout the A/D converter to provide excellent common-mode signal rejection. The ADC122S625 features an external reference that can be varied from 1.0V to V_A .

The ADC122S625's serial data output is binary 2's complement and is compatible with several standards, such as SPI™, QSPI™, MICROWIRE™, and many common DSP serial interfaces. The serial clock (SCLK) and chip select bar ($\overline{\text{CS}}$) are shared by both channels.

Operating from a single 5V analog supply and a reference voltage of 2.5V, the total power consumption while operating at 200 kSPS is typically 8.6 mW. With the ADC122S625 operating in power-down mode, the power consumption reduces to 2.6 μW . The differential input, low power consumption, and small size make the ADC122S625 ideal for direct connection to sensors in motor control applications.

Operation is specified over the industrial temperature range of -40°C to $+105^{\circ}\text{C}$ and clock rates of 1.6 MHz to 6.4 MHz. The ADC122S625 is available in a 10-lead VSSOP package.

Connection Diagram

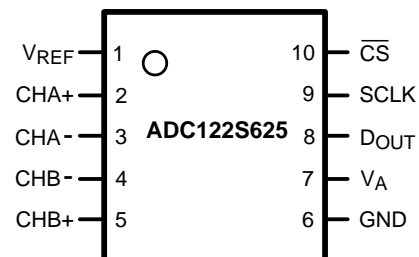

Please be aware that an important notice concerning availability, standard warranty, and use in critical applications of Texas Instruments semiconductor products and disclaimers thereto appears at the end of this data sheet.

SPI, QSPI are trademarks of Motorola, Incorporated.

All other trademarks are the property of their respective owners.

Block Diagram

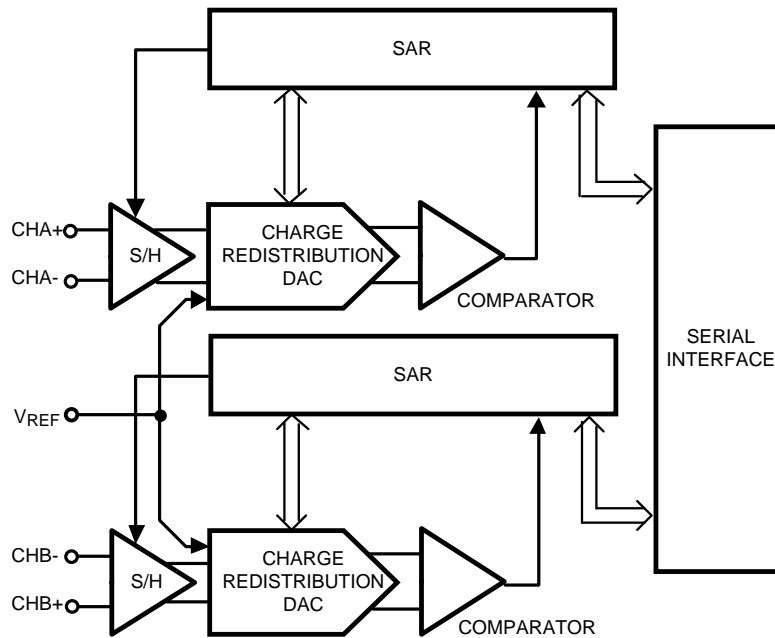

PIN DESCRIPTIONS AND EQUIVALENT CIRCUITS

Pin No.	Symbol	Description
1	V_{REF}	Voltage Reference Input. A voltage reference between 1V and V_A must be applied to this input. V_{REF} must be decoupled to GND with a minimum ceramic capacitor value of 0.1 μ F. A bulk capacitor value of 1.0 μ F to 10 μ F in parallel with the 0.1 μ F is recommended for enhanced performance.
2	CHA+	Non-Inverting Input for Channel A. CHA+ is the positive analog input for the differential signal applied to Channel A.
3	CHA-	Inverting Input for Channel A. CHA- is the negative analog input for the differential signal applied to Channel A.
4	CHB-	Inverting Input for Channel B. CHB- is the negative analog input for the differential signal applied to Channel B.
5	CHB+	Non-Inverting Input for Channel B. CHB+ is the positive analog input for the differential signal applied to Channel B.
6	GND	Ground. GND is the ground reference point for all signals applied to the ADC122S625.
7	V_A	Analog Power Supply input. A voltage source between 4.5V and 5.5V must be applied to this input. V_A must be decoupled to GND with a minimum ceramic capacitor value of 0.1 μ F. A bulk capacitor value of 1.0 μ F to 10 μ F in parallel with the 0.1 μ F is recommended for enhanced performance.
8	D_{OUT}	Serial Data Output for Channel A and Channel B. The serial data output word is comprised of 4 null bits, 12 data bits (ChA conversion result), 4 null bits, and 12 data bits (ChB conversion result). During a conversion, the data is output on the falling edges of SCLK and is valid on the rising edges.
9	SCLK	Serial Clock. SCLK is used to control data transfer and serves as the conversion clock.
10	\overline{CS}	Chip Select Bar. \overline{CS} is active low. The ADC122S625 is actively converting when \overline{CS} is LOW and Power-Down Mode when \overline{CS} is HIGH. A conversion begins on the fall of \overline{CS} .



These devices have limited built-in ESD protection. The leads should be shorted together or the device placed in conductive foam during storage or handling to prevent electrostatic damage to the MOS gates.

Absolute Maximum Ratings⁽¹⁾⁽²⁾⁽³⁾

Analog Supply Voltage V_A	-0.3V to 6.5V
Voltage on Any Pin to GND	-0.3V to ($V_A + 0.3V$)
Input Current at Any Pin ⁽⁴⁾	±10 mA
Package Input Current ⁽⁴⁾	±50 mA
Power Consumption at $T_A = 25^\circ\text{C}$	See ⁽⁵⁾
ESD Susceptibility ⁽⁶⁾	
Human Body Model	2500V
Machine Model	250V
Charge Device Model	1000V
Junction Temperature	+150°C
Storage Temperature	-65°C to +150°C

- (1) Absolute Maximum Ratings indicate limits beyond which damage to the device may occur. Operating Ratings indicate conditions for which the device is functional, but do not ensure specific performance limits. For ensured specifications and test conditions, see the Electrical Characteristics. The ensured specifications apply only for the test conditions listed. Some performance characteristics may degrade when the device is not operated under the listed test conditions. Operation of the device beyond the maximum Operating Ratings is not recommended.
- (2) All voltages are measured with respect to GND = 0V, unless otherwise specified.
- (3) If Military/Aerospace specified devices are required, please contact the Texas Instruments Sales Office/ Distributors for availability and specifications.
- (4) When the input voltage at any pin exceeds the power supplies (that is, $V_{IN} < \text{GND}$ or $V_{IN} > V_A$), the current at that pin should be limited to 10 mA. The 50 mA maximum package input current rating limits the number of pins that can safely exceed the power supplies with an input current of 10 mA to five.
- (5) The absolute maximum junction temperature (T_{Jmax}) for this device is 150°C. The maximum allowable power dissipation is dictated by T_{Jmax} , the junction-to-ambient thermal resistance (θ_{JA}), and the ambient temperature (T_A), and can be calculated using the formula $P_{DMAX} = (T_{Jmax} - T_A)/\theta_{JA}$. The values for maximum power dissipation listed above will be reached only when the ADC122S625 is operated in a severe fault condition (e.g. when input or output pins are driven beyond the power supply voltages, or the power supply polarity is reversed). Such conditions should always be avoided.
- (6) Human body model is a 100 pF capacitor discharged through a 1.5 kΩ resistor. Machine model is a 220 pF capacitor discharged through 0 Ω. Charge device model simulates a pin slowly acquiring charge (such as from a device sliding down the feeder in an automated assembler) then rapidly being discharged.

Operating Ratings⁽¹⁾⁽²⁾

Operating Temperature Range	$-40^\circ\text{C} \leq T_A \leq +105^\circ\text{C}$
Supply Voltage, V_A	+4.5V to +5.5V
Reference Voltage, V_{REF}	1.0V to V_A
Input Common-Mode Voltage, V_{CM}	See Figure 36
Digital Input Pins Voltage Range	0 to V_A
Clock Frequency	1.6 MHz to 6.4 MHz
Differential Analog Input Voltage	$-V_{REF}$ to $+V_{REF}$

- (1) Absolute Maximum Ratings indicate limits beyond which damage to the device may occur. Operating Ratings indicate conditions for which the device is functional, but do not ensure specific performance limits. For ensured specifications and test conditions, see the Electrical Characteristics. The ensured specifications apply only for the test conditions listed. Some performance characteristics may degrade when the device is not operated under the listed test conditions. Operation of the device beyond the maximum Operating Ratings is not recommended.
- (2) All voltages are measured with respect to GND = 0V, unless otherwise specified.

Package Thermal Resistance

Package	θ_{JA}
10-lead VSSOP	240°C / W
Soldering process must comply with TI's Reflow Temperature Profile specifications. Refer to http://www.ti.com/packaging ⁽¹⁾	

- (1) Reflow temperature profiles are different for lead-free packages.

ADC122S625 Converter Electrical Characteristics ⁽¹⁾

The following specifications apply for $V_A = +4.5V$ to $5.5V$, $V_{REF} = 2.5V$, $f_{SCLK} = 1.6$ to 6.4 MHz, $f_{IN} = 20$ kHz, $C_L = 25$ pF, unless otherwise noted. **Boldface limits apply for $T_A = T_{MIN}$ to T_{MAX}** ; all other limits are at $T_A = 25^\circ C$.

Symbol	Parameter	Conditions	Typical	Limits	Units
STATIC CONVERTER CHARACTERISTICS					
	Resolution with No Missing Codes			12	Bits
INL	Integral Non-Linearity		± 0.5	± 1	LSB (max)
	Integral Non-Linearity Matching		0.02		LSB
DNL	Differential Non-Linearity		± 0.4	± 0.95	LSB (max)
	Differential Non-Linearity Matching		0.02		LSB
OE	Offset Error		0.2	± 3	LSB (max)
	Offset Error Matching		0.1		LSB
GE	Positive Gain Error		-2	± 5	LSB (max)
	Positive Gain Error Matching		0.2		LSB
	Negative Gain Error		3	± 8	LSB (max)
	Negative Gain Error Matching		0.2		LSB
DYNAMIC CONVERTER CHARACTERISTICS					
SINAD	Signal-to-Noise Plus Distortion Ratio	$f_{IN} = 20$ kHz, -0.1 dBFS	72.5	69.5	dBc (min)
SNR	Signal-to-Noise Ratio	$f_{IN} = 20$ kHz, -0.1 dBFS	73.2	71	dBc (min)
THD	Total Harmonic Distortion	$f_{IN} = 20$ kHz, -0.1 dBFS	-83	-72	dBc (max)
SFDR	Spurious-Free Dynamic Range	$f_{IN} = 20$ kHz, -0.1 dBFS	84	72	dBc (min)
ENOB	Effective Number of Bits	$f_{IN} = 20$ kHz, -0.1 dBFS	11.8	11.25	bits (min)
FPBW	-3 dB Full Power Bandwidth	Output at 70.7%FS with FS Input	Differential Input	26	MHz
		Single-Ended Input	22	MHz	
ISOL	Channel-to-Channel Isolation	$f_{IN} < 1$ MHz	-90		dBc
ANALOG INPUT CHARACTERISTICS					
V_{IN}	Differential Input Range			$-V_{REF}$	V (min)
				$+V_{REF}$	V (max)
I_{DCL}	DC Leakage Current	$V_{IN} = V_{REF}$ or $V_{IN} = -V_{REF}$		± 1	μA (max)
C_{INA}	Input Capacitance	In Track Mode	20		pF
		In Hold Mode	3		pF
CMRR	Common Mode Rejection Ratio	See the Specification Definitions for the test condition	-90		dB
V_{REF}	Reference Voltage Range			1.0	V (min)
				V_A	V (max)
DIGITAL INPUT CHARACTERISTICS					
V_{IH}	Input High Voltage			2.4	V (min)
V_{IL}	Input Low Voltage			0.8	V (max)
I_{IN}	Input Current	$V_{IN} = 0V$ or V_A		± 1	μA (max)
C_{IND}	Input Capacitance		2	4	pF (max)
DIGITAL OUTPUT CHARACTERISTICS					
V_{OH}	Output High Voltage	$I_{SOURCE} = 200 \mu A$	$V_A - 0.02$	$V_A - 0.2$	V (min)
		$I_{SOURCE} = 1$ mA	$V_A - 0.09$		V
V_{OL}	Output Low Voltage	$I_{SINK} = 200 \mu A$	0.01	0.4	V (max)
		$I_{SINK} = 1$ mA	0.08		V
I_{OZH}, I_{OZL}	TRI-STATE Leakage Current	Force 0V or V_A		± 1	μA (max)
C_{OUT}	TRI-STATE Output Capacitance	Force 0V or V_A	2	4	pF (max)
	Output Coding		Binary 2'S Complement		

(1) Tested limits are specified to TI's AOQL (Average Outgoing Quality Level).

ADC122S625 Converter Electrical Characteristics ⁽¹⁾ (continued)

The following specifications apply for $V_A = +4.5V$ to $5.5V$, $V_{REF} = 2.5V$, $f_{SCLK} = 1.6$ to 6.4 MHz, $f_{IN} = 20$ kHz, $C_L = 25$ pF, unless otherwise noted. **Boldface limits apply for $T_A = T_{MIN}$ to T_{MAX}** ; all other limits are at $T_A = 25^\circ C$.

Symbol	Parameter	Conditions	Typical	Limits	Units
POWER SUPPLY CHARACTERISTICS					
V_A	Analog Supply Voltage			4.5	V (min)
				5.5	V (max)
I_{VA} (Conv)	Analog Supply Current, Continuously Converting	$f_{SCLK} = 6.4$ MHz, $f_S = 200$ kSPS, $f_{IN} = 20$ kHz, $V_A = 5V$	1.7	2.45	mA (max)
I_{VREF} (Conv)	Reference Current, Continuously Converting	$f_{SCLK} = 6.4$ MHz, $f_S = 200$ kSPS, $V_{REF} = 2.5V$	20	40	μA (max)
I_{VA} (PD)	Analog Supply Current, Power Down Mode (\overline{CS} high)	$f_{SCLK} = 6.4$ MHz, $V_A = 5.0V$ $f_{SCLK} = 0$, $V_A = 5.0V$ ⁽²⁾	10		μA
			0.5	1.1	μA (max)
I_{VREF} (PD)	Reference Current, Power Down Mode (\overline{CS} high)	$f_{SCLK} = 6.4$ MHz, $V_{REF} = 2.5V$ $f_{SCLK} = 0$, $V_{REF} = 2.5V$ ⁽²⁾	0.05		μA
			0.05	0.1	μA (max)
PWR (Conv)	Power Consumption, Continuously Converting	$f_{SCLK} = 6.4$ MHz, $f_S = 200$ kSPS, $f_{IN} = 20$ kHz, $V_A = 5.0V$, $V_{REF} = 2.5V$	8.6	12.4	mW (max)
PWR (PD)	Power Consumption, Power Down Mode (\overline{CS} high)	$f_{SCLK} = 6.4$ MHz, $V_A = 5.0V$, $V_{REF} = 2.5V$ $f_{SCLK} = 0$, $V_A = 5.0V$, $V_{REF} = 2.5V$	50		μW
			2.6	5.8	μW (max)
PSRR	Power Supply Rejection Ratio	See the Specification Definitions for the test condition	-85		dB
AC ELECTRICAL CHARACTERISTICS					
f_{SCLK}	Maximum Clock Frequency		20	6.4	MHz (min)
f_{SCLK}	Minimum Clock Frequency		0.8	1.6	MHz (max)
f_S	Maximum Sample Rate ⁽³⁾		625	200	kSPS (min)
	Minimum Sample Rate		25	50	kSPS (min)
t_{ACQ}	Track/Hold Acquisition Time			3	SCLK cycles
t_{CONV}	Conversion Time			12	SCLK cycles
t_{AD}	Aperture Delay		6		ns

(2) Specified by design, characterization, or statistical analysis and is not tested at final test.

(3) While the maximum sample rate is $f_{SCLK}/32$, the actual sample rate may be lower than this by having the \overline{CS} rate slower than $f_{SCLK}/32$.

ADC122S625 Timing Specifications ⁽¹⁾

The following specifications apply for $V_A = +4.5V$ to $5.5V$, $V_{REF} = 2.5V$, $f_{SCLK} = 1.6$ MHz to 6.4 MHz, $C_L = 25$ pF, unless otherwise noted. **Boldface limits apply for $T_A = T_{MIN}$ to T_{MAX}** ; all other limits $T_A = 25^\circ C$.

Symbol	Parameter	Conditions	Typical	Limits	Units
t_{CSSU}	\overline{CS} Setup Time prior to an SCLK rising edge		4	7	ns (min)
			$1/f_{SCLK}$	$1/f_{SCLK} - 3$	ns (max)
t_{EN}	D_{OUT} Enable Time after the falling edge of \overline{CS}		9	20	ns (max)
t_{DH}	D_{OUT} Hold time after an SCLK Falling edge		9	6	ns (min)
t_{DA}	D_{OUT} Access time after an SCLK Falling edge		20	26	ns (max)
t_{DIS}	D_{OUT} Disable Time after the rising edge of \overline{CS} ⁽²⁾		10	20	ns (max)
t_{CH}	SCLK High Time			25	ns (min)
t_{CL}	SCLK Low Time			25	ns (min)
t_r	D_{OUT} Rise Time		7		ns
t_f	D_{OUT} Fall Time		7		ns

(1) Tested limits are specified to TI's AOQL (Average Outgoing Quality Level).

(2) t_{DIS} is the time for D_{OUT} to change 10%.

Timing Diagrams

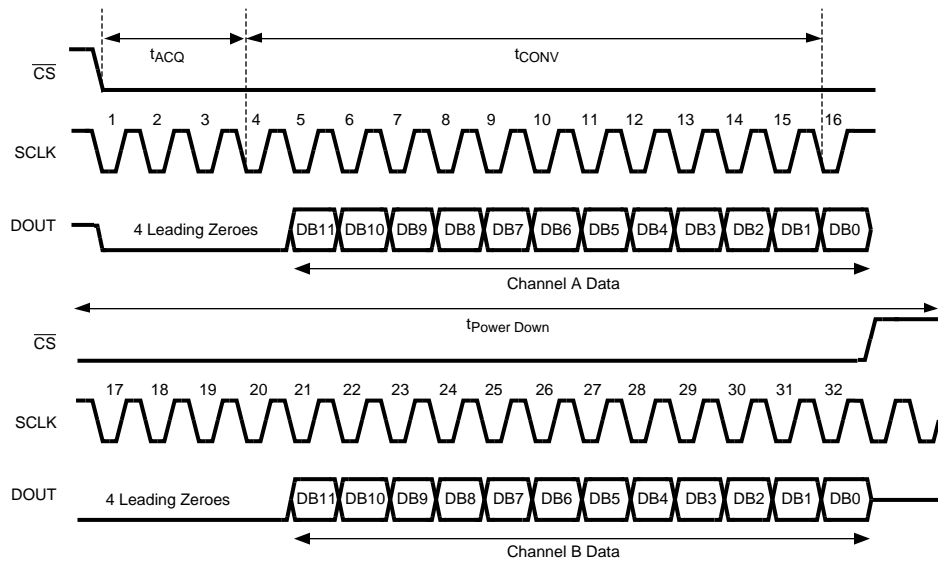

Figure 1. ADC122S625 Single Conversion Timing Diagram

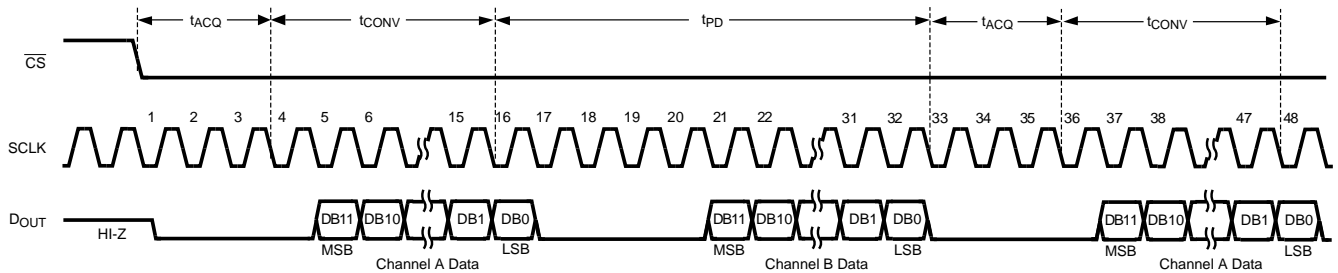

Figure 2. ADC122S625 Continuous Conversion Timing Diagram

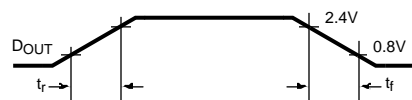

Figure 3. D_{OUT} Rise and Fall Times

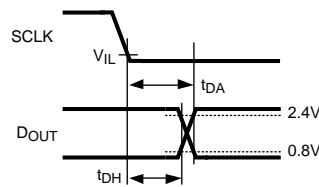

Figure 4. D_{OUT} Hold and Access Times

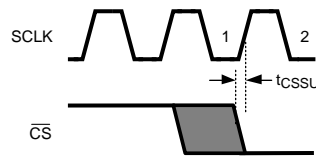

Figure 5. Valid \overline{CS} Assertion Times

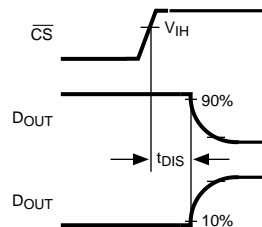

Figure 6. Voltage Waveform for t_{DIS}

Specification Definitions

APERTURE DELAY is the time between the fourth falling edge of SCLK and the time when the input signal is acquired or held for conversion.

COMMON MODE REJECTION RATIO (CMRR) is a measure of how well in-phase signals common to both input pins are rejected.

To calculate CMRR, the change in output offset is measured while the common mode input voltage is changed from 2V to 3V.

$$CMRR = 20 \text{ LOG} (\Delta \text{ Output Offset} / \Delta \text{ Common Input}) \quad (1)$$

CONVERSION TIME is the time required, after the input voltage is acquired, for the ADC to convert the input voltage to a digital word.

DIFFERENTIAL NON-LINEARITY (DNL) is the measure of the maximum deviation from the ideal step size of 1 LSB.

DUTY CYCLE is the ratio of the time that a repetitive digital waveform is high to the total time of one period. The specification here refers to the SCLK.

EFFECTIVE NUMBER OF BITS (ENOB, or EFFECTIVE BITS) is another method of specifying Signal-to-Noise and Distortion or SINAD. ENOB is defined as $(\text{SINAD} - 1.76) / 6.02$ and says that the converter is equivalent to a perfect ADC of this (ENOB) number of bits.

FULL POWER BANDWIDTH is a measure of the frequency at which the reconstructed output fundamental drops 3 dB below its low frequency value for a full scale input.

INTEGRAL NON-LINEARITY (INL) is a measure of the deviation of each individual code from a line drawn from negative full scale ($\frac{1}{2}$ LSB below the first code transition) through positive full scale ($\frac{1}{2}$ LSB above the last code transition). The deviation of any given code from this straight line is measured from the center of that code value.

MISSING CODES are those output codes that will never appear at the ADC outputs. The ADC122S625 is specified not to have any missing codes.

NEGATIVE FULL-SCALE ERROR is the difference between the differential input voltage at which the output code transitions from negative full scale to the next code and $-V_{REF} + 0.5 \text{ LSB}$.

NEGATIVE GAIN ERROR is the difference between the negative full-scale error and the offset error.

OFFSET ERROR is the difference between the differential input voltage at which the output code transitions from code 000h to 001h and $1/2 \text{ LSB}$.

POSITIVE FULL-SCALE ERROR is the difference between the differential input voltage at which the output code transitions to positive full scale and V_{REF} minus 1.5 LSB.

POSITIVE GAIN ERROR is the difference between the positive full-scale error and the offset error.

POWER SUPPLY REJECTION RATIO (PSRR) is a measure of how well a change in supply voltage is rejected. PSRR is calculated from the ratio of the change in offset error for a given change in supply voltage, expressed in dB. For the ADC122S625, V_A is changed from 4.5V to 5.5V.

$$\text{PSRR} = 20 \text{ LOG } (\Delta\text{Offset} / \Delta V_A) \quad (2)$$

SIGNAL TO NOISE RATIO (SNR) is the ratio, expressed in dB, of the rms value of the input signal to the rms value of the sum of all other spectral components below one-half the sampling frequency, not including harmonics or d.c.

SIGNAL TO NOISE PLUS DISTORTION (S/N+D or SINAD) Is the ratio, expressed in dB, of the rms value of the input signal to the rms value of all of the other spectral components below half the clock frequency, including harmonics but excluding d.c.

SPURIOUS FREE DYNAMIC RANGE (SFDR) is the difference, expressed in dB, between the desired signal amplitude to the amplitude of the peak spurious spectral component, where a spurious spectral component is any signal present in the output spectrum that is not present at the input and may or may not be a harmonic.

TOTAL HARMONIC DISTORTION (THD) is the ratio of the rms total of the first five harmonic components at the output to the rms level of the input signal frequency as seen at the output, expressed in dB. THD is calculated as

$$\text{THD} = 20 \cdot \log_{10} \sqrt{\frac{A_{f_2}^2 + \dots + A_{f_6}^2}{A_{f_1}^2}} \quad (3)$$

where A_{f_1} is the RMS power of the input frequency at the output and A_{f_2} through A_{f_6} are the RMS power in the first 5 harmonic frequencies.

THROUGHPUT TIME is the minimum time required between the start of two successive conversion.

Typical Performance Characteristics

$V_A = 5.0V$, $V_{REF} = 2.5V$, $T_A = +25^\circ C$, $f_{SAMPLE} = 200$ kSPS, $f_{SCLK} = 6.4$ MHz, $f_{IN} = 20$ kHz unless otherwise stated.

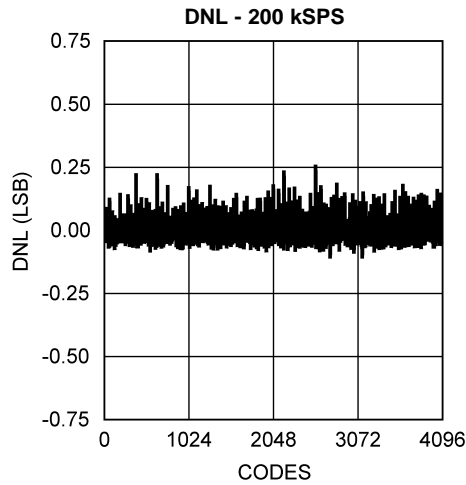

Figure 7.

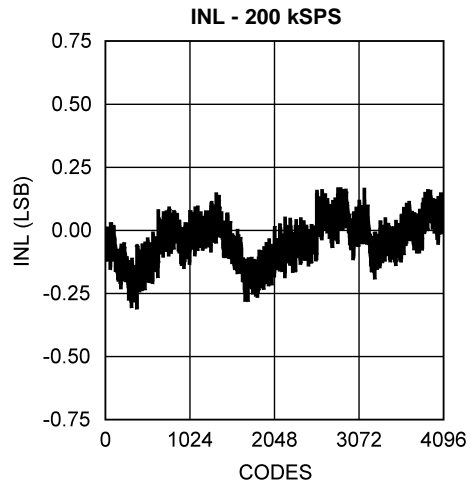

Figure 8.

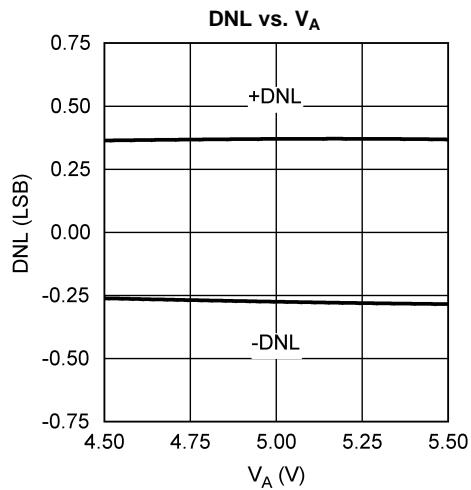

Figure 9.

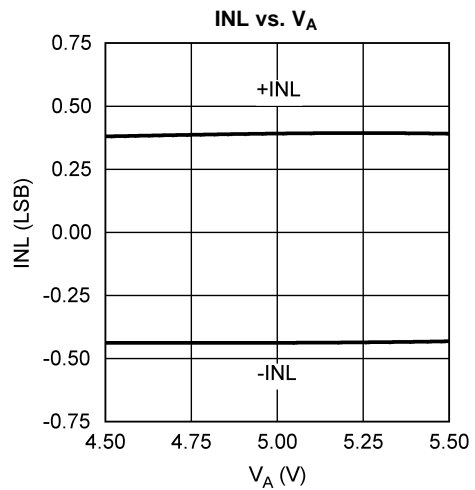

Figure 10.

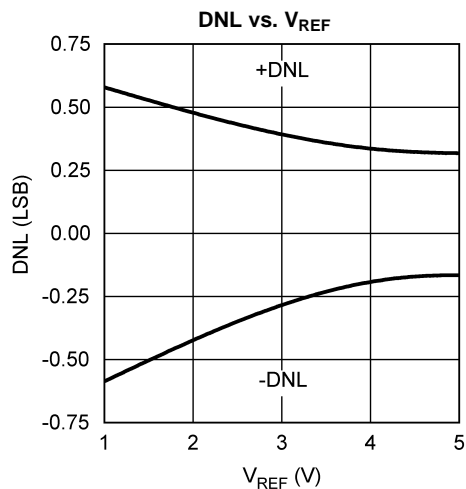

Figure 11.

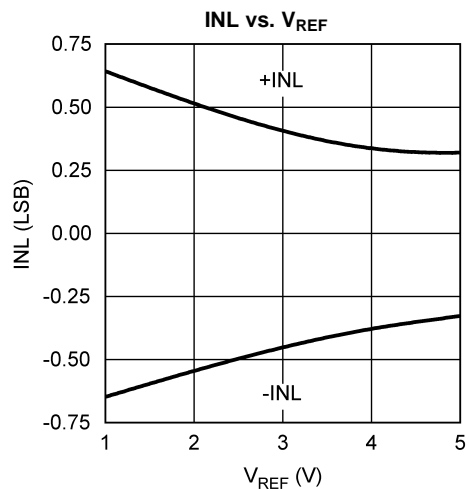

Figure 12.

Typical Performance Characteristics (continued)

$V_A = 5.0V$, $V_{REF} = 2.5V$, $T_A = +25^\circ C$, $f_{SAMPLE} = 200$ kSPS, $f_{SCLK} = 6.4$ MHz, $f_{IN} = 20$ kHz unless otherwise stated.

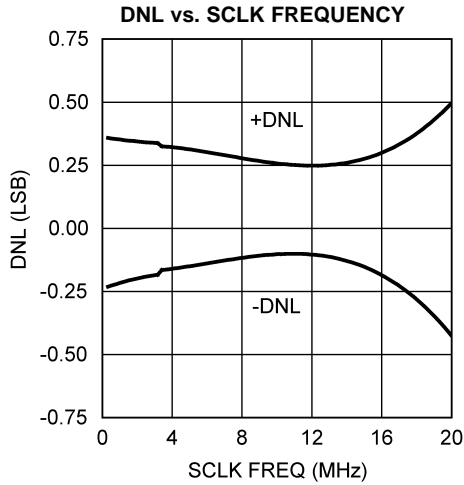

Figure 13.

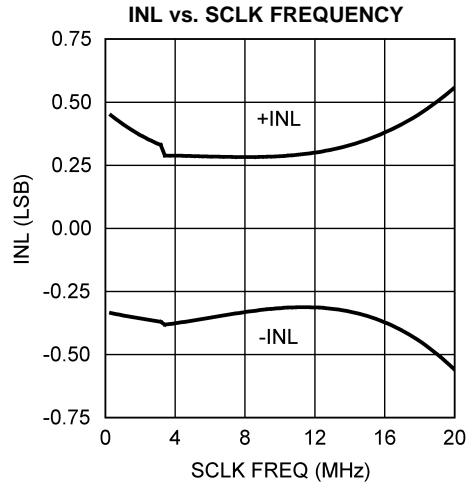

Figure 14.

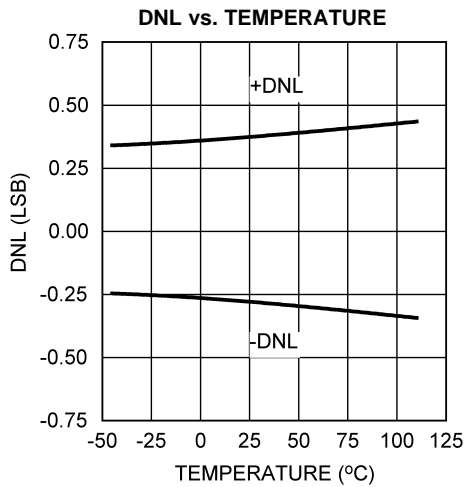

Figure 15.

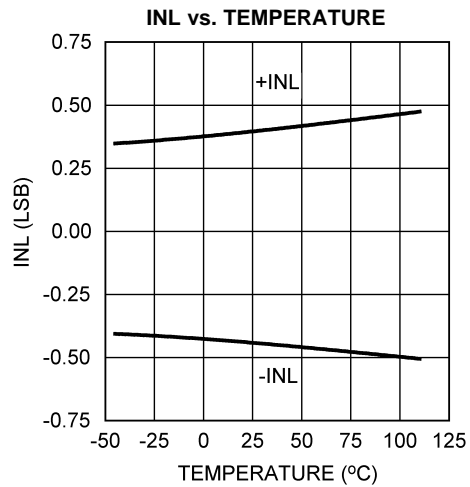

Figure 16.

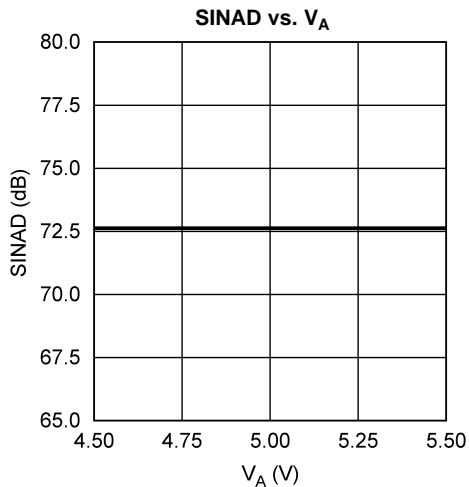

Figure 17.

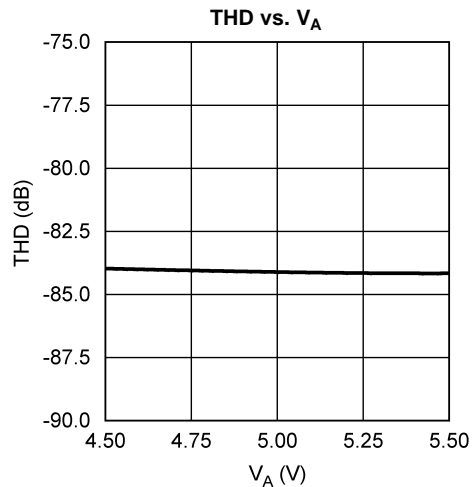

Figure 18.

Typical Performance Characteristics (continued)

$V_A = 5.0V$, $V_{REF} = 2.5V$, $T_A = +25^\circ C$, $f_{SAMPLE} = 200$ kSPS, $f_{SCLK} = 6.4$ MHz, $f_{IN} = 20$ kHz unless otherwise stated.

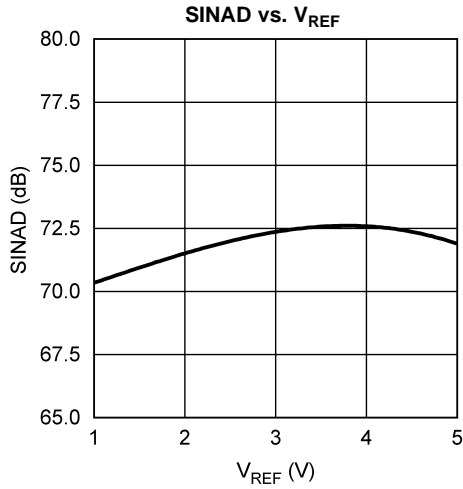

Figure 19.

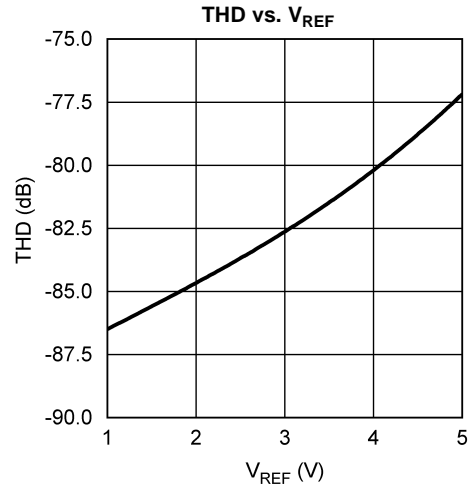

Figure 20.

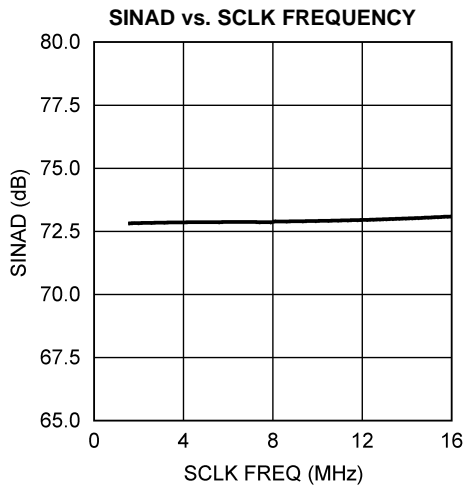

Figure 21.

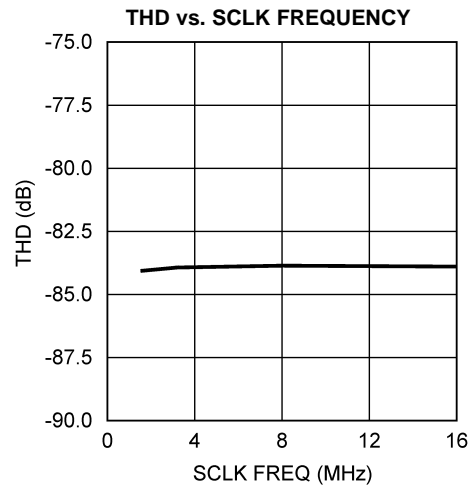

Figure 22.

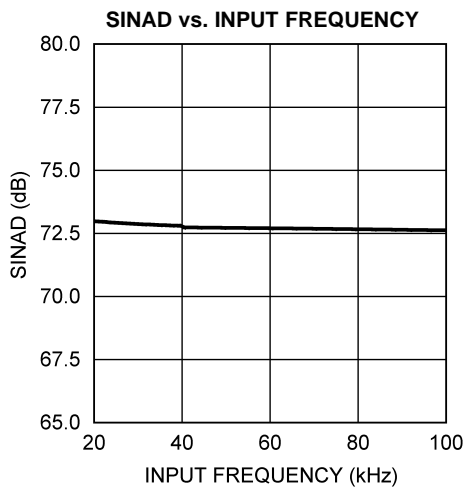

Figure 23.

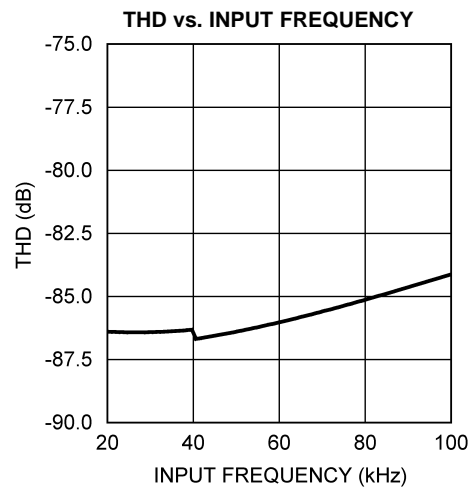

Figure 24.

Typical Performance Characteristics (continued)

$V_A = 5.0V$, $V_{REF} = 2.5V$, $T_A = +25^\circ C$, $f_{SAMPLE} = 200\text{ kSPS}$, $f_{SCLK} = 6.4\text{ MHz}$, $f_{IN} = 20\text{ kHz}$ unless otherwise stated.

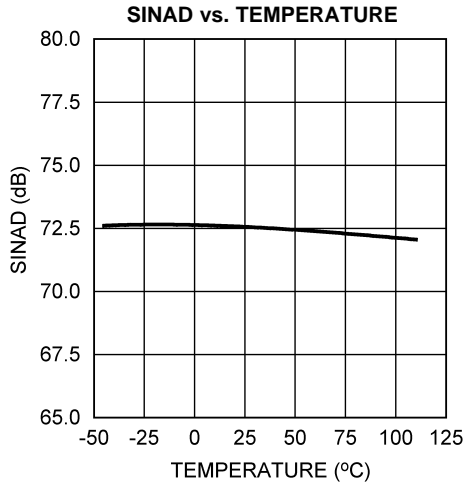

Figure 25.

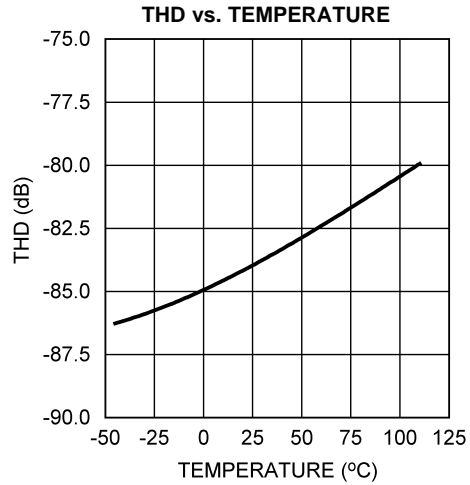

Figure 26.

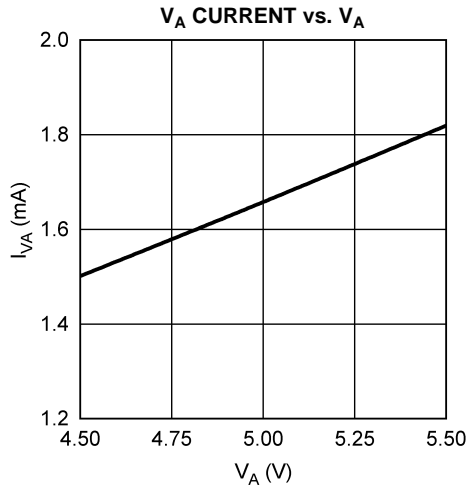

Figure 27.

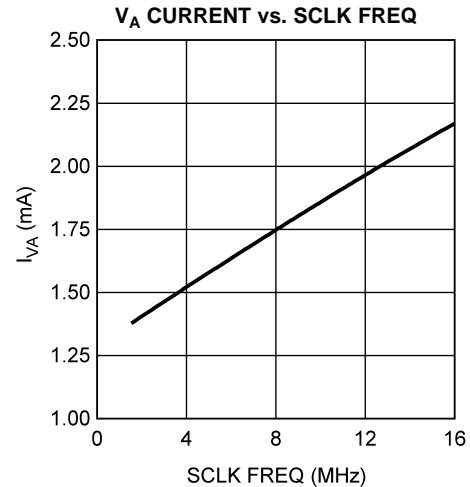

Figure 28.

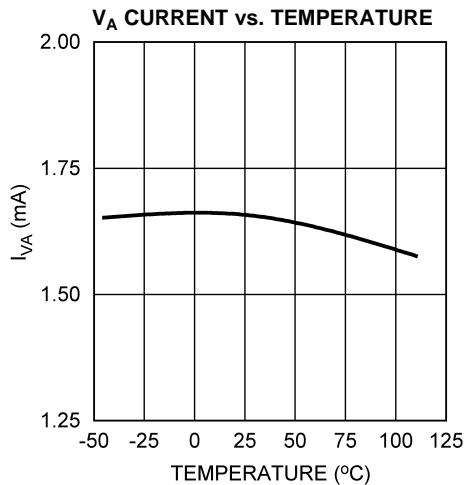

Figure 29.

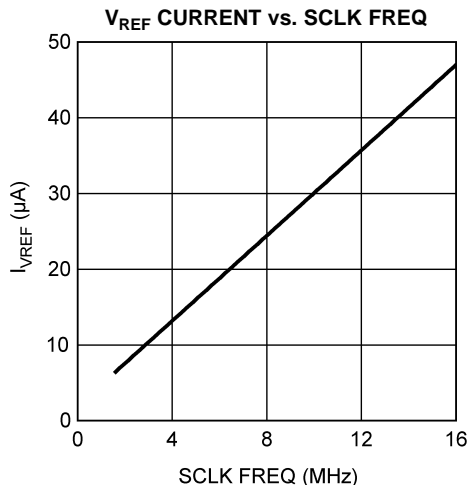

Figure 30.

Typical Performance Characteristics (continued)

$V_A = 5.0V$, $V_{REF} = 2.5V$, $T_A = +25^\circ C$, $f_{SAMPLE} = 200$ kSPS, $f_{SCLK} = 6.4$ MHz, $f_{IN} = 20$ kHz unless otherwise stated.

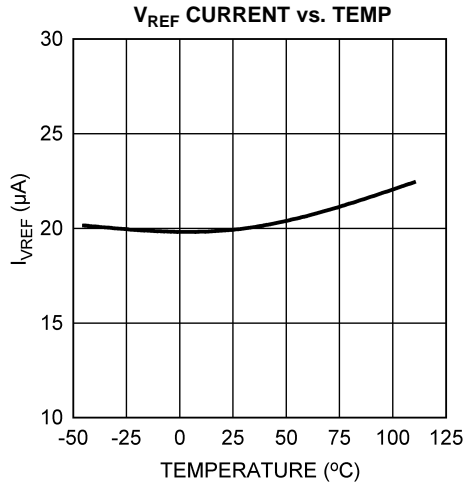

Figure 31.

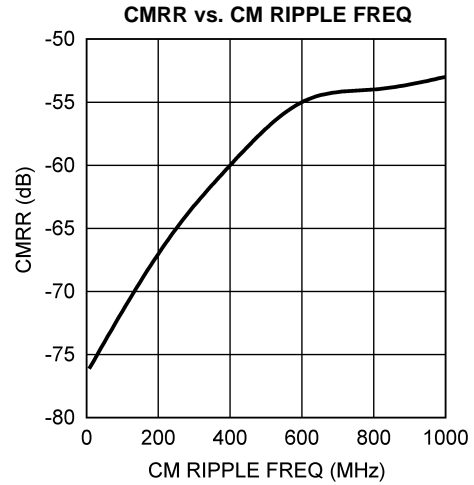

Figure 32.

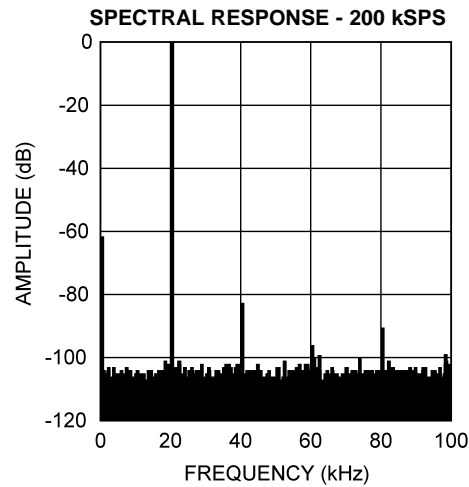

Figure 33.

FUNCTIONAL DESCRIPTION

The ADC122S625 is a dual 12-bit, simultaneous sampling Analog-to-Digital (A/D) converter. The converter is based on a successive-approximation register (SAR) architecture where the differential nature of the analog inputs is maintained from the internal track-and-hold circuits throughout the A/D converter. The analog inputs on both channels are sampled simultaneously to preserve their relative phase information to each other. The architecture and process allow the ADC122S625 to acquire and convert dual analog signals at sample rates up to 200 kSPS while consuming very little power.

The ADC122S625 requires an external reference, external clock, and an analog power supply. The analog supply (V_A) can range from 4.5V to 5.5V and the external reference can be any voltage between 1V and V_A . The value of the reference voltage determines the range of the analog input, while the reference input current depends upon the conversion rate.

Analog inputs are presented at the inputs of Channel A and Channel B. Upon initiation of a conversion, the differential input at these pins is sampled on the internal capacitor array. The analog input signals are disconnected from the external circuitry while a conversion is in progress.

The external clock can take on values as indicated in the Electrical Characteristics Table. The duty cycle of the clock is essentially unimportant, provided the minimum clock high and low times are met. The minimum clock frequency is set by internal capacitor leakage. Each conversion requires thirty-two clock cycles to complete.

The ADC122S625 offers a high-speed serial data output that is binary 2's complement and compatible with several standards, such as SPI™, QSPI™, MICROWIRE™, and many common DSP serial interfaces. The digital conversion result of Channel A and Channel B is clocked out on the falling edges of the SCLK input and is provided serially at D_{OUT} , most significant bit first. The result of Channel A is output before the result of Channel B, with four zeros in between the two results. The digital data provided on D_{OUT} is that of the conversion currently in progress. With \overline{CS} held low after the result of Channel B is output, the ADC122S625 will continuously convert the analog inputs until \overline{CS} is de-asserted (brought high). Having a single, serial D_{OUT} makes the ADC122S625 an excellent replacement for two independent ADCs that are part of a daisy chain configuration and allows a system designer to save valuable board space and power.

REFERENCE INPUT

The externally supplied reference voltage sets the analog input range. The ADC122S625 will operate with a reference voltage in the range of 1V to V_A .

Operation with a reference voltage below 1V is also possible with slightly diminished performance. As the reference voltage (V_{REF}) is reduced, the range of acceptable analog input voltages is reduced. Assuming a proper common-mode input voltage, the differential peak-to-peak input range is limited to twice V_{REF} . See [Input Common Mode Voltage](#) for more details. Reducing the value of V_{REF} also reduces the size of the least significant bit (LSB). The size of one LSB is equal to twice the reference voltage divided by 4096. When the LSB size goes below the noise floor of the ADC122S625, the noise will span an increasing number of codes and overall performance will suffer. For example, dynamic signals will have their SNR degrade, while D.C. measurements will have their code uncertainty increase. Since the noise is Gaussian in nature, the effects of this noise can be reduced by averaging the results of a number of consecutive conversions.

Additionally, since offset and gain errors are specified in LSB, any offset and/or gain errors inherent in the A/D converter will increase in terms of LSB size as the reference voltage is reduced.

The reference input and the analog inputs are connected to the capacitor array through a switch matrix when the input is sampled. Hence, the current requirements at the reference and at the analog inputs are a series of transient spikes that occur at a frequency dependent on the operating sample rate of the ADC122S625.

The reference current changes only slightly with temperature. See the curves, [Reference Current vs. SCLK Frequency](#) and [Reference Current vs. Temperature](#) in the [Typical Performance Characteristics](#) section for additional details.

ANALOG SIGNAL INPUTS

The ADC122S625 has dual differential inputs where the effective input voltage that is digitized is CHA+ minus CHA- (DIFFINA) and CHB+ minus CHB- (DIFFINB). As is the case with all differential input A/D converters, operation with a fully differential input signal or voltage will provide better performance than with a single-ended input. However, the ADC122S625 can be presented with a single-ended input as shown in [Single-Ended Input Operation](#) and the Application Circuits.

The current required to recharge the input sampling capacitor will cause voltage spikes at the + and - inputs. Do not try to filter out these noise spikes. Rather, ensure that the noise spikes settle out during the acquisition period (three SCLK cycles after the fall of CS). This is true for both Channel A and Channel B since both channels are converted simultaneously on the fourth falling edge of SCLK after CS is asserted.

Differential Input Operation

With a fully differential input voltage or signal, a positive full scale output code (0111 1111 1111b or 7FFh) will be obtained when DIFFINA or DIFFINB is greater than or equal to $V_{REF} - 1.5 \text{ LSB}$. A negative full scale code (1000 0000 0000b or 800h) will be obtained when DIFFINA or DIFFINB is greater than or equal to $-V_{REF} + 0.5 \text{ LSB}$. This ignores gain, offset and linearity errors, which will affect the exact differential input voltage that will determine any given output code. [Figure 34](#) shows the ADC122S625 being driven by a full-scale differential source.

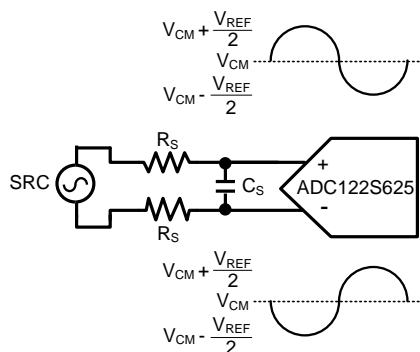

Figure 34. Differential Input

Single-Ended Input Operation

For single-ended operation, the non-inverting inputs of the ADC122S625 can be driven with a signal that has a maximum to minimum value range that is equal to or less than twice the reference voltage. The inverting inputs should be biased at a stable voltage that is halfway between these maximum and minimum values. In order to utilize the entire dynamic range of the ADC122S625, the reference voltage is limited at $V_A / 2$. This allows the non-inverting inputs the maximum swing range of ground to V_A . [Figure 35](#) shows the ADC122S625 being driven by a full-scale single-ended source. Even though the design of the ADC122S625 is optimized for a differential input, there is very little performance degradation while operating the ADC122S625 in single-ended fashion.

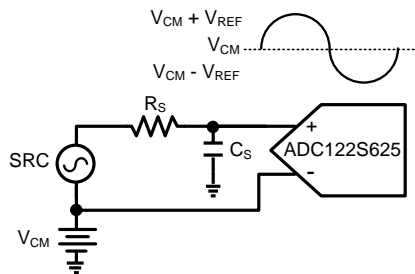

Figure 35. Single-Ended Input

Input Common Mode Voltage

The allowable input common mode voltage (V_{CM}) range depends upon the supply and reference voltages used for the ADC122S625. The ranges of V_{CM} for differential and single-ended operation are depicted in [Figure 36](#) and [Figure 37](#). Equations for calculating the minimum and maximum common mode voltages for differential and single-ended operation are shown in [Table 1](#).

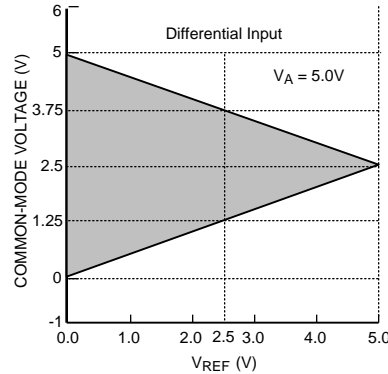

Figure 36. V_{CM} range for Differential Input operation

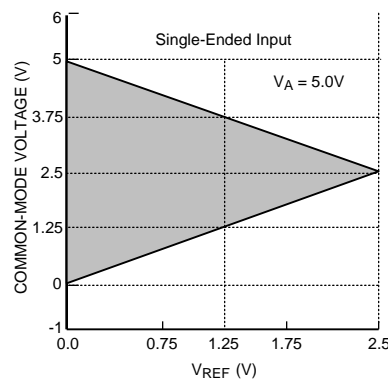

Figure 37. V_{CM} range for single-ended operation

Table 1. Allowable V_{CM} Range

Input Signal	Minimum V_{CM}	Maximum V_{CM}
Differential	$V_{REF} / 2$	$V_A - V_{REF} / 2$
Single-Ended	V_{REF}	$V_A - V_{REF}$

SERIAL DIGITAL INTERFACE

The ADC122S625 communicates via a synchronous serial interface as shown in the [Timing Diagrams](#) section. \overline{CS} , chip select, initiates conversions and frames the serial data transfers. SCLK (serial clock) controls both the conversion process and the timing of the serial data. D_{OUT} is the serial data output pin, where the conversion results of Channel A and Channel B are sent as a serial data stream, with the result of Channel A output before the result of Channel B.

A serial frame is initiated on the falling edge of \overline{CS} and ends on the rising edge of \overline{CS} . The ADC122S625's D_{OUT} is in a high impedance state when \overline{CS} is high (asserted) and is active when \overline{CS} is low (de-asserted); thus \overline{CS} acts as an output enable. A timing diagram for a single conversion is shown in [Figure 1](#).

During the first three cycles of SCLK, the ADC122S625 is in acquisition mode (t_{ACQ}), tracking the input voltage on both Channel A and Channel B. For the next twelve SCLK cycles (t_{CONV}), the conversion of Channel A and Channel B is accomplished simultaneously and data is presented on D_{OUT} , one bit at a time. SCLK falling edges one through four clock out leading zeros while falling edges five through sixteen clock out the conversion result of Channel A, MSB first. The process is repeated in order to clock out the result of Channel B, with SCLK falling edges seventeen through twenty clocking out four zeros followed by falling edges twenty-one through thirty-two clocking out the conversion result of Channel B. If there is more than one conversion in a frame (continuous conversion mode), the ADC122S625 will re-enter acquisition mode on the falling edge of SCLK after the $N*32$ rising edge of SCLK and re-enter conversion mode on the $N*32+4$ falling edge of SCLK as shown in [Figure 2](#). "N" is an integer value.

The ADC122S625 can enter acquisition mode under three different conditions. The first condition involves \overline{CS} going low (asserted) with SCLK high. In this case, the ADC122S625 enters acquisition mode on the first falling edge of SCLK after \overline{CS} is asserted. In the second condition, \overline{CS} goes low with SCLK low. Under this condition, the ADC122S625 automatically enters acquisition mode and the falling edge of \overline{CS} is seen as the first falling edge of SCLK. In the third condition, \overline{CS} and SCLK go low simultaneously and the ADC122S625 immediately enters acquisition mode. While there is no timing restriction with respect to the falling edges of \overline{CS} and the falling edge of SCLK, see [Figure 5](#) for setup and hold time requirements for the falling edge of \overline{CS} with respect to the rising edge of SCLK.

\overline{CS} Input

The \overline{CS} (chip select bar) is an active low input that is TTL and CMOS compatible. The ADC122S625 transitions from acquisition mode, to conversion mode, to power-down mode when \overline{CS} is low and is always in power-down mode when \overline{CS} is high. The falling edge of \overline{CS} marks the beginning of a conversion where the input to Channel A and Channel B are tracked by the input sampling capacitor. The rising edge of \overline{CS} marks the end of a conversion window. As a result, \overline{CS} frames the conversion window and can be used to control the sample rate of the ADC122S625. While the SCLK frequency is limited to a range of 1.6 MHz to 6.4 MHz, the frequency of \overline{CS} has no limitation. This allows a system designer to operate the ADC122S625 at sample rates approaching zero samples per second if conserving power is very important. See [Burst Mode Operation](#) for more details. Multiple conversions can occur within a given conversion frame with each conversion requiring thirty-two SCLK cycles. This is referred to as continuous conversion mode and is shown in [Figure 2](#) of the [Timing Diagrams](#) section.

Proper operation requires that the fall of \overline{CS} not occur simultaneously with a rising edge of SCLK. If the fall of \overline{CS} occurs during the rising edge of SCLK, the data might be clocked out one bit early. Whether or not the data is clocked out early depends upon how close the \overline{CS} transition is to the SCLK transition, the device temperature, and characteristics of the individual device. To ensure that the MSB is always clocked out at a given time (the 5th falling edge of SCLK), it is essential that the fall of \overline{CS} always meet the timing requirement specified in the Timing Specification table.

SCLK Input

The SCLK (serial clock) serves two purposes in the ADC122S625. It is used by the ADC122S625 as the conversion clock and it is used as the serial clock to output the conversion results. The SCLK input is TTL and CMOS compatible. Internal settling time requirements limit the maximum clock frequency while internal capacitor leakage limits the minimum clock frequency. The ADC122S625 offers specified performance with the clock rates indicated in the Electrical Characteristics Table.

Data Output(s)

The conversion result of Channel A and Channel B is output on D_{OUT} , with the result of Channel A being output before the result of Channel B. The data output format of the ADC122S625 is binary, two's complement, as shown in [Table 2](#). This table indicates the ideal output code for a given input voltage and does not include the effects of offset, gain error, linearity errors, or noise. Each data output bit is output on the falling edges of SCLK.

Table 2. Ideal Output Code vs. Input Voltage

Analog Input (+IN) – (–IN)	2's Complement Binary Output	2's Comp. Hex Code	2's Comp. Dec Code
$V_{REF} - 1.5 \text{ LSB}$	0111 1111 1111	7FF	2047
+ 0.5 LSB	0000 0000 0001	001	1
– 0.5 LSB	0000 0000 0000	000	0
0V – 1.5 LSB	1111 1111 1111	FFF	–1
$-V_{REF} + 0.5 \text{ LSB}$	1000 0000 0000	800	–2048

While data is output on the falling edges of SCLK, receiving systems have the option of capturing the data from the ADC122S625 on the subsequent rising or falling edge of SCLK. If a receiving system is going to capture data on the subsequent falling edges of SCLK, it is important to make sure that the minimum hold time after an SCLK falling edge (t_{DH}) is acceptable. See [Figure 4](#) for D_{OUT} hold and access times.

D_{OUT} is enabled on the falling edge of \overline{CS} and disabled on the rising edge of \overline{CS} . If \overline{CS} is raised prior to the 16th falling edge of SCLK, the current conversion is aborted and D_{OUT} will go into its high impedance state. A new conversion will begin when \overline{CS} is taken LOW.

Applications Information

OPERATING CONDITIONS

We recommend that the following conditions be observed for operation of the ADC122S625:

$$-40^{\circ}\text{C} \leq T_A \leq +105^{\circ}\text{C}$$

$$+4.5\text{V} \leq V_A \leq +5.5\text{V}$$

$$1\text{V} \leq V_{REF} \leq V_A$$

$$1.6 \text{ MHz} \leq f_{SCLK} \leq 6.4 \text{ MHz}$$

V_{CM} : See [Input Common Mode Voltage](#)

POWER CONSUMPTION

The architecture, design, and fabrication process allow the ADC122S625 to operate at conversion rates up to 200 kSPS while consuming very little power. The ADC122S625 consumes the least amount of power while operating in power down mode. For applications where power consumption is critical, the ADC122S625 should be operated in power down mode as often as the application will tolerate. To further reduce power consumption, stop the SCLK while \overline{CS} is high.

Burst Mode Operation

Normal operation of the ADC122S625 requires the SCLK frequency to be thirty-two times the sample rate and the \overline{CS} rate to be the same as the sample rate. However, in order to minimize power consumption in applications requiring sample rates below 50 kSPS, the ADC122S625 should be run with an SCLK frequency of 6.4 MHz and a \overline{CS} rate as slow as the system requires. When this is accomplished, the ADC122S625 is operating in burst mode. The ADC122S625 enters into power down mode at the end of each conversion, minimizing power consumption. This causes the converter to spend the longest possible time in power down mode. Since power consumption scales directly with conversion rate, minimizing power consumption requires determining the lowest conversion rate that will satisfy the requirements of the system.

POWER SUPPLY CONSIDERATIONS AND PCB LAYOUT

For best performance, care should be taken with the physical layout of the printed circuit board. This is especially true with a low reference voltage or when the conversion rate is high. At high clock rates there is less time for settling, so it is important that any noise settles out before the conversion begins.

Analog Power Supply

Any ADC architecture is sensitive to spikes on the power supply, reference, and ground pins. These spikes may originate from switching power supplies, digital logic, high power devices, and other sources. Power to the ADC122S625 should be clean and well bypassed. A 0.1 μF ceramic bypass capacitor and a 1 μF to 10 μF capacitor should be used to bypass the ADC122S625 supply, with the 0.1 μF capacitor placed as close to the ADC122S625 package as possible.

Since the ADC122S625 has a separate analog and reference pin, the user has two options. The first option is to tie the analog and reference supply pins together and power them with the same power supply. This is the most cost effective way of powering the ADC122S625 but it is also the least ideal. As stated previously, noise from the analog supply pin can couple into the reference supply pin and adversely affect performance. The other option involves the user powering the analog and reference supply pins with separate supply voltages. These supply voltages can have the same amplitude or they can be different. The only design constraint is that the reference supply voltage be less than the analog supply voltage.

Voltage Reference

The reference source must have a low output impedance and needs to be bypassed with a minimum capacitor value of 0.1 μF . A larger capacitor value of 1 μF to 10 μF placed in parallel with the 0.1 μF is preferred. While the ADC122S625 draws very little current from the reference on average, there are higher instantaneous current spikes at the reference input.

The reference input of the ADC122S625, like all A/D converters, does not reject noise or voltage variations. Keep this in mind if the reference voltage is derived from the power supply. Any noise and/or ripple from the supply that is not rejected by the external reference circuitry will appear in the digital results. The use of an active reference source is recommended. The LM4040 and LM4050 shunt reference families and the LM4132 and LM4140 series reference families are excellent choices for a reference source.

PCB Layout

Capacitive coupling between the noisy digital circuitry and the sensitive analog circuitry can lead to poor performance. The solution is to keep the analog circuitry separated from the digital circuitry and the clock line as short as possible. Digital circuits create substantial supply and ground current transients. The logic noise generated could have significant impact upon system noise performance. To avoid performance degradation of the ADC122S625 due to supply noise, avoid sharing the power supplies for V_A and V_{REF} with other digital circuitry on the board.

Generally, analog and digital lines should cross each other at 90° to avoid crosstalk. However, to maximize accuracy in high resolution systems, avoid crossing analog and digital lines altogether. It is important to keep clock lines as short as possible and isolated from other lines, including other digital lines. In addition, the clock line should also be treated as a transmission line and be properly terminated. The analog input should be isolated from noisy signal traces to avoid coupling of spurious signals into the input. Any external component (e.g., a filter capacitor) connected between the converter's input pins and ground or to the reference input pin and ground should be connected to a very clean point in the ground plane.

A single, uniform ground plane and the use of split power planes are recommended. The power planes should be located within the same board layer. All analog circuitry (input amplifiers, filters, reference components, etc.) should be placed over the analog power plane. All digital circuitry and I/O lines should be placed over the digital power plane. Furthermore, the GND pin on the ADC122S625 and all the components in the reference circuitry and input signal chain that are connected to ground should be connected to the ground plane at a quiet point. Avoid connecting these points too close to the ground point of a microprocessor, microcontroller, digital signal processor, or other high power digital device.

APPLICATION CIRCUITS

The following figures are examples of the ADC122S625 in typical application circuits. These circuits are basic and will generally require modification for specific circumstances.

Data Acquisition

Figure 38 shows a basic low cost, low power data acquisition circuit. The analog supply pin is powered by the system +5V supply and the 2.5V reference voltage is generated by the LM4040-2.5 shunt reference.

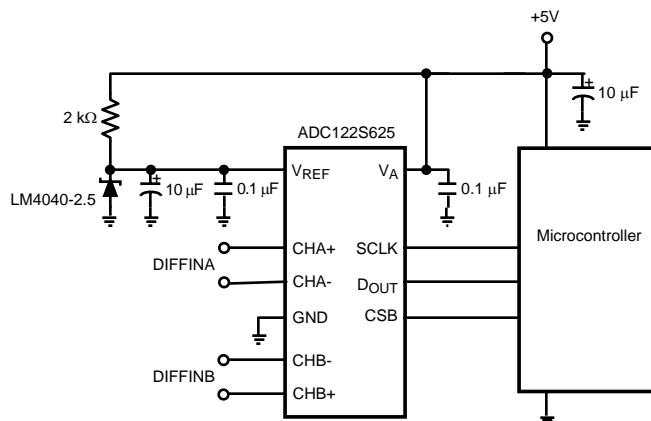

Figure 38. Low cost, low power Data Acquisition System

Current Sensing Application

Figure 39 shows an example of interfacing a pair of current transducers to the ADC122S625. The current transducers convert an input current into a voltage that is converted by the ADC122S625. Since the output voltage of the current transducers are single-ended and centered around a common-mode voltage of 2.5V, the ADC122S625 is configured with the output of the transducer driving the non-inverting inputs and the common-mode output voltage of the transducer driving the inverting input. The output of the transducer has an output range of $\pm 2V$ around the common-mode voltage of 2.5V. As a result, a series reference voltage of 2.0V is connected to the ADC122S625. This will allow all of the codes of the ADC122S625 to be available for the application. This configuration of the ADC122S625 is referred to as a single-ended application of a differential ADC. All of the elements in the application are conveniently powered by the same +5V power supply, keeping circuit complexity and cost to a minimum.

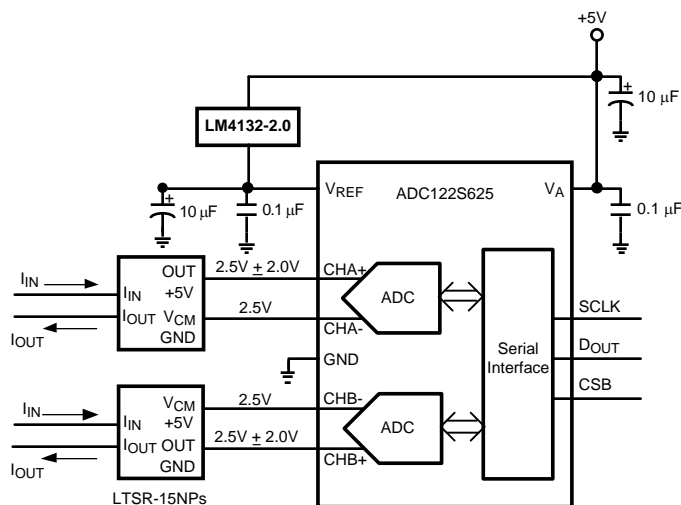

Figure 39. Interfacing the ADC122S625 to a Current Transducer

Bridge Sensor Application

Figure 40 shows an example of interfacing the ADC122S625 to a pair of bridge sensors. The application assumes that the bridge sensors require buffering and amplification to fully utilize the dynamic range of the ADC and thus optimize the performance of the entire signal path. The amplification stage for each ADC input consists of a pair of opamps from the LMP7704. The amplification stage offers the benefit of high input impedance and potentially high amplification. On the other hand, it offers no common-mode rejection of noise coming from the bridge sensors. The application circuit assumes the bridge sensors are powered from the same +5V power supply voltage as the analog supply pin on the ADC122S625. This has the benefit of providing the ideal common-mode input voltage for the ADC122S625 while keeping design complexity and cost to a minimum. The LM4132-4.1, a 4.1V series reference, is used as the reference voltage in the application.

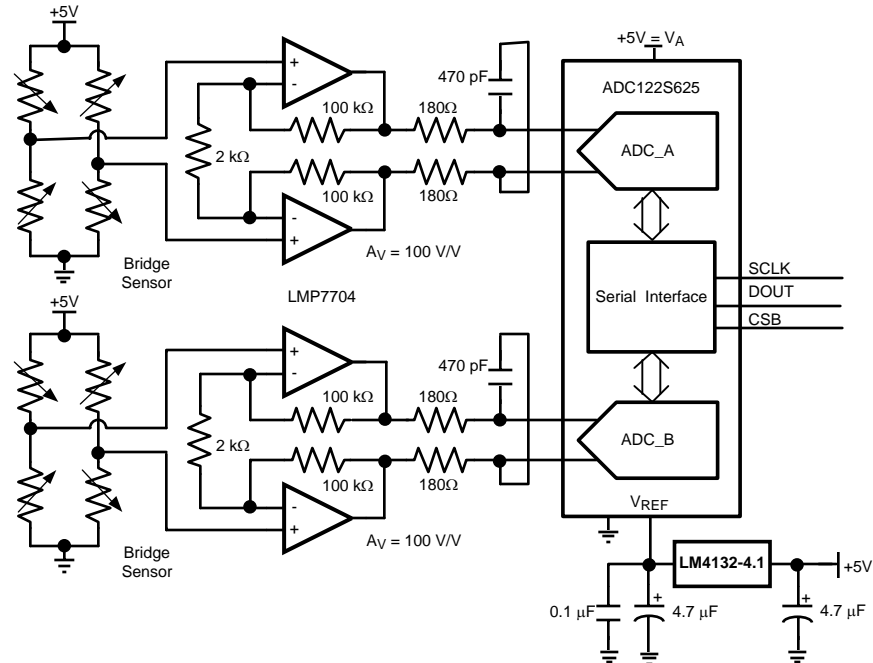

Figure 40. Interfacing the ADC122S625 to Bridge Sensors

REVISION HISTORY

Changes from Original (March 2013) to Revision A	Page
• Changed layout of National Data Sheet to TI format	21

PACKAGING INFORMATION

Orderable part number	Status (1)	Material type (2)	Package Pins	Package qty Carrier	RoHS (3)	Lead finish/ Ball material (4)	MSL rating/ Peak reflow (5)	Op temp (°C)	Part marking (6)
ADC122S625C1MM/NO.A	Active	Production	VSSOP (DGS) 10	1000 SMALL T&R	Yes	SN	Level-1-260C-UNLIM	-40 to 105	X35C
ADC122S625C1MM/NOPB	Active	Production	VSSOP (DGS) 10	1000 SMALL T&R	Yes	SN	Level-1-260C-UNLIM	-40 to 105	X35C
ADC122S625C1MMX/NO.A	Active	Production	VSSOP (DGS) 10	3500 LARGE T&R	Yes	SN	Level-1-260C-UNLIM	-40 to 105	X35C
ADC122S625C1MMX/NOPB	Active	Production	VSSOP (DGS) 10	3500 LARGE T&R	Yes	SN	Level-1-260C-UNLIM	-40 to 105	X35C

(1) **Status:** For more details on status, see our [product life cycle](#).

(2) **Material type:** When designated, preproduction parts are prototypes/experimental devices, and are not yet approved or released for full production. Testing and final process, including without limitation quality assurance, reliability performance testing, and/or process qualification, may not yet be complete, and this item is subject to further changes or possible discontinuation. If available for ordering, purchases will be subject to an additional waiver at checkout, and are intended for early internal evaluation purposes only. These items are sold without warranties of any kind.

(3) **RoHS values:** Yes, No, RoHS Exempt. See the [TI RoHS Statement](#) for additional information and value definition.

(4) **Lead finish/Ball material:** Parts may have multiple material finish options. Finish options are separated by a vertical ruled line. Lead finish/Ball material values may wrap to two lines if the finish value exceeds the maximum column width.

(5) **MSL rating/Peak reflow:** The moisture sensitivity level ratings and peak solder (reflow) temperatures. In the event that a part has multiple moisture sensitivity ratings, only the lowest level per JEDEC standards is shown. Refer to the shipping label for the actual reflow temperature that will be used to mount the part to the printed circuit board.

(6) **Part marking:** There may be an additional marking, which relates to the logo, the lot trace code information, or the environmental category of the part.

Multiple part markings will be inside parentheses. Only one part marking contained in parentheses and separated by a "~" will appear on a part. If a line is indented then it is a continuation of the previous line and the two combined represent the entire part marking for that device.

Important Information and Disclaimer: The information provided on this page represents TI's knowledge and belief as of the date that it is provided. TI bases its knowledge and belief on information provided by third parties, and makes no representation or warranty as to the accuracy of such information. Efforts are underway to better integrate information from third parties. TI has taken and continues to take reasonable steps to provide representative and accurate information but may not have conducted destructive testing or chemical analysis on incoming materials and chemicals. TI and TI suppliers consider certain information to be proprietary, and thus CAS numbers and other limited information may not be available for release.

In no event shall TI's liability arising out of such information exceed the total purchase price of the TI part(s) at issue in this document sold by TI to Customer on an annual basis.

TAPE AND REEL INFORMATION

QUADRANT ASSIGNMENTS FOR PIN 1 ORIENTATION IN TAPE

*All dimensions are nominal

Device	Package Type	Package Drawing	Pins	SPQ	Reel Diameter (mm)	Reel Width W1 (mm)	A0 (mm)	B0 (mm)	K0 (mm)	P1 (mm)	W (mm)	Pin1 Quadrant
ADC122S625C1MM/NOPB	VSSOP	DGS	10	1000	177.8	12.4	5.3	3.4	1.4	8.0	12.0	Q1
ADC122S625C1MMX/NOPB	VSSOP	DGS	10	3500	330.0	12.4	5.3	3.4	1.4	8.0	12.0	Q1

TAPE AND REEL BOX DIMENSIONS

*All dimensions are nominal

Device	Package Type	Package Drawing	Pins	SPQ	Length (mm)	Width (mm)	Height (mm)
ADC122S625CIMM/NOPB	VSSOP	DGS	10	1000	210.0	185.0	35.0
ADC122S625CIMMX/ NOPB	VSSOP	DGS	10	3500	367.0	367.0	35.0

DGS0010A



PACKAGE OUTLINE

VSSOP - 1.1 mm max height

SMALL OUTLINE PACKAGE



4221984/A 05/2015

NOTES:

1. All linear dimensions are in millimeters. Any dimensions in parenthesis are for reference only. Dimensioning and tolerancing per ASME Y14.5M.
2. This drawing is subject to change without notice.
3. This dimension does not include mold flash, protrusions, or gate burrs. Mold flash, protrusions, or gate burrs shall not exceed 0.15 mm per side.
4. This dimension does not include interlead flash. Interlead flash shall not exceed 0.25 mm per side.
5. Reference JEDEC registration MO-187, variation BA.

EXAMPLE BOARD LAYOUT

DGS0010A

VSSOP - 1.1 mm max height

SMALL OUTLINE PACKAGE



LAND PATTERN EXAMPLE
SCALE:10X



SOLDER MASK DETAILS
NOT TO SCALE

4221984/A 05/2015

NOTES: (continued)

6. Publication IPC-7351 may have alternate designs.
7. Solder mask tolerances between and around signal pads can vary based on board fabrication site.

EXAMPLE STENCIL DESIGN

DGS0010A

VSSOP - 1.1 mm max height

SMALL OUTLINE PACKAGE



SOLDER PASTE EXAMPLE
BASED ON 0.125 mm THICK STENCIL
SCALE:10X

4221984/A 05/2015

NOTES: (continued)

8. Laser cutting apertures with trapezoidal walls and rounded corners may offer better paste release. IPC-7525 may have alternate design recommendations.
9. Board assembly site may have different recommendations for stencil design.

IMPORTANT NOTICE AND DISCLAIMER

TI PROVIDES TECHNICAL AND RELIABILITY DATA (INCLUDING DATA SHEETS), DESIGN RESOURCES (INCLUDING REFERENCE DESIGNS), APPLICATION OR OTHER DESIGN ADVICE, WEB TOOLS, SAFETY INFORMATION, AND OTHER RESOURCES "AS IS" AND WITH ALL FAULTS, AND DISCLAIMS ALL WARRANTIES, EXPRESS AND IMPLIED, INCLUDING WITHOUT LIMITATION ANY IMPLIED WARRANTIES OF MERCHANTABILITY, FITNESS FOR A PARTICULAR PURPOSE OR NON-INFRINGEMENT OF THIRD PARTY INTELLECTUAL PROPERTY RIGHTS.

These resources are intended for skilled developers designing with TI products. You are solely responsible for (1) selecting the appropriate TI products for your application, (2) designing, validating and testing your application, and (3) ensuring your application meets applicable standards, and any other safety, security, regulatory or other requirements.

These resources are subject to change without notice. TI grants you permission to use these resources only for development of an application that uses the TI products described in the resource. Other reproduction and display of these resources is prohibited. No license is granted to any other TI intellectual property right or to any third party intellectual property right. TI disclaims responsibility for, and you will fully indemnify TI and its representatives against, any claims, damages, costs, losses, and liabilities arising out of your use of these resources.

TI's products are provided subject to [TI's Terms of Sale](#) or other applicable terms available either on [ti.com](https://www.ti.com) or provided in conjunction with such TI products. TI's provision of these resources does not expand or otherwise alter TI's applicable warranties or warranty disclaimers for TI products.

TI objects to and rejects any additional or different terms you may have proposed.

Mailing Address: Texas Instruments, Post Office Box 655303, Dallas, Texas 75265

Copyright © 2025, Texas Instruments Incorporated